

Snapshots were taken on 23rd September 2021

```
RI#show ip route
Codes: C - connected, S - static, R - RIP, M - mobile, B - BGP
       D - EIGRP, EX - EIGRP external, O - OSPF, IA - OSPF inter area
       N1 - OSPF NSSA external type 1, N2 - OSPF NSSA external type 2
       E1 - OSPF external type 1, E2 - OSPF external type 2
       I - IS-IS, su - IS-IS summary, L1 - IS-IS level-1, L2 - IS-IS level-2
       ia - IS-IS inter area, * - candidate default, U - per-user static route
       o - ODR, P - periodic downloaded static route
Gateway of last resort is 192.168.30.10 to network 0.0.0.0
192.168.30.0/29 is subnetted, 2 subnets
C      192.168.30.0 is directly connected, FastEthernet0/0
C      192.168.30.8 is directly connected, Serial0/0.1
192.168.10.0/24 is variably subnetted, 2 subnets, 2 masks
O IA   192.168.10.32/28 [110/193] via 192.168.30.10, 00:18:49, Serial0/0.1
O IA   192.168.10.0/27 [110/192] via 192.168.30.10, 00:18:49, Serial0/0.1
192.168.20.0/30 is subnetted, 1 subnets
O IA   192.168.20.0 [110/128] via 192.168.30.10, 00:18:49, Serial0/0.1
192.168.50.0/32 is subnetted, 1 subnets
C      192.168.50.1 is directly connected, Loopback0
O*IA  0.0.0.0/0 [110/84] via 192.168.30.10, 00:10:36, Serial0/0.1
```

Refer to the exhibit. What is the metric of the route to the 192.168.10.33/28 subnet?

- 84
- 110
- 128
- 192
- 193

What is the maximum bandwidth of a T1 point-to-point connection?

- 1.544 Mbps
- 2.048 Mbps
- 34.368 Mbps
- 43.7 Mbps

In software-defined architecture, which plane handles switching for traffic through a Cisco router?

- data
- application
- control
- management

Snapshots were taken on 23rd September 2021

What is a network appliance that checks the state of a packet to determine whether the packet is legitimate?

- Layer 2 switch
- firewall
- load balancer
- LAN controller

```
Switch#show etherchannel summary
[output omitted]
```

Group	Port-channel	Protocol	Ports
10	Po10 (SU)	LACP	Gi0/0 (P) Gi0/1 (P)
20	Po20 (SU)	LACP	Gi0/2 (P) Gi0/3 (P)

Refer to the exhibit. Which two commands when used together create port channel 10? (Choose two.)

- int range g0/0-1
channel-group 10 mode active
- int range g0/0-1
channel-group 10 mode desirable
- int range g0/0-1
channel-group 10 mode passive
- int range g0/0-1
channel-group 10 mode auto
- int range g0/0-1
channel-group 10 mode on

What is the effect when loopback interfaces and the configured router ID are absent during the OSPF Process configuration?

- The lowest IP address is incremented by 1 and selected as the router ID.
- No router ID is set, and the OSPF protocol does not run.
- The highest up/up physical interface IP address is selected as the router ID.
- The router ID 0.0.0.0 is selected and placed in the OSPF process.

Snapshots were taken on 23rd September 2021

Which two events occur automatically when a device is added to Cisco DNA Center? (Choose two.)

- The device is assigned to the Local site.
- The device is placed into the Provisioned state.
- The device is placed into the Managed state.
- The device is placed into the Unmanaged state.
- The device is assigned to the Global site.

What are two benefits of network automation? (Choose two.)

- increased network security
- reduced operational costs
- faster changes with more reliable results
- reduced hardware footprint
- fewer network failures

R1 has learned route 192.168.12.0/24 via IS-IS, OSPF, RIP, and Internal EIGRP. Under normal operating conditions, which routing protocol is installed in the routing table?

- IS-IS
- Internal EIGRP
- OSPF
- RIP

Snapshots were taken on 23rd September 2021

When a WPA2-PSK WLAN is configured in the Wireless LAN Controller, what is the minimum number of characters that is required in ASCII format?

- 6
- 8
- 12
- 18

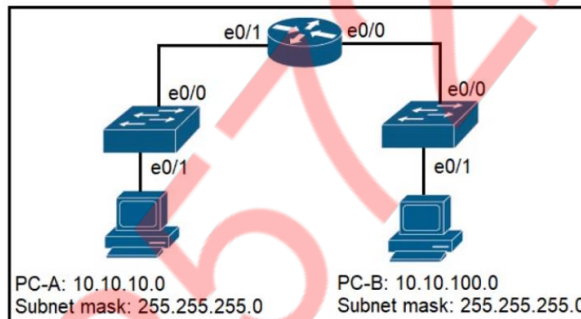

Refer to the exhibit. When PC-A sends traffic to PC-B, which network component is in charge of receiving the packet from PC-A, verifying the IP addresses, and forwarding the packet to PC-B?

- Layer 2 switch
- router
- load balancer
- firewall

What identifies the functionality of virtual machines?

- Each hypervisor supports a single virtual machine and a single software switch.
- Virtualized servers run efficiently when physically connected to a switch that is separate from the hypervisor.
- The hypervisor communicates on Layer 3 without the need for additional resources.
- The hypervisor virtualizes physical components including CPU, memory, and storage.

Snapshots were taken on 23rd September 2021

```
R1#show ip interface brief
Interface          IP-Address      OK? Method Status      Protocol
FastEthernet0/0    unassigned      YES NVRAM   administratively down  down
GigabitEthernet1/0 192.168.0.1     YES NVRAM   up          up
GigabitEthernet2/0 10.10.1.10      YES manual  up          up
GigabitEthernet3/0 10.10.10.20     YES manual  up          up
GigabitEthernet4/0 unassigned      YES NVRAM   administratively down  down
Loopback0          172.16.15.10   YES manual  up          up
```

Refer to the exhibit. What does router R1 use as its OSPF router-ID?

- 10.10.1.10
- 10.10.10.20
- 172.16.15.10
- 192.168.0.1

Which two tasks must be performed to configure NTP to a trusted server in client mode on a single network device? (Choose two.)

- Disable NTP broadcasts.
- Set the NTP server private key.
- Verify the time zone.
- Enable NTP authentication.
- Specify the IP address of the NTP server.

Which 802.11 frame type is indicated by a probe response after a client sends a probe request?

- management
- data
- control
- action

Snapshots were taken on 23rd September 2021

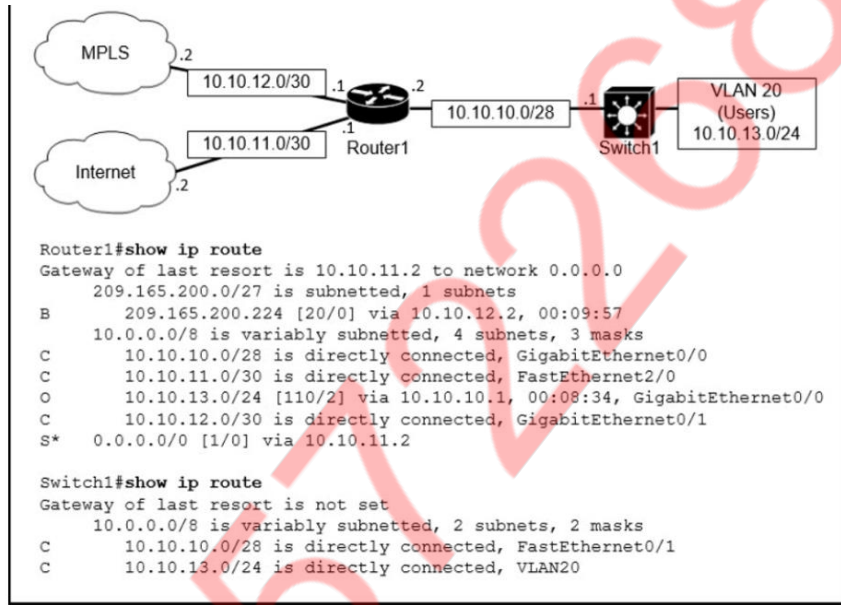

Refer to the exhibit. Which path is used by the router for Internet traffic?

- 209.165.200.0/27
- 10.10.10.0/28
- 10.10.13.0/24
- 0.0.0.0/0

Which IPv6 address block forwards packets to a multicast address rather than a unicast address?

- 2000::/3
- FC00::/7
- FE80::/10
- FF00::/12

Snapshots were taken on 23rd September 2021

What does physical access control regulate?

- access to servers to prevent malicious activity
- access to networking equipment and facilities
- access to computer networks and file systems
- access to specific networks based on business function

A user configured OSPF in a single area between two routers. A serial interface connecting R1 and R2 is running encapsulation PPP. By default, which OSPF network type is seen on this interface when the user types `show ip ospf interface` on R1 or R2?

- broadcast
- point-to-point
- point-to-multipoint
- nonbroadcast

Which two conditions must be met before SSH operates normally on a Cisco IOS switch? (Choose two.)

- Telnet must be disabled on the switch.
- A console password must be configured on the switch.
- IP routing must be enabled on the switch.
- The `ip domain-name` command must be configured on the switch.
- The switch must be running a k9 (crypto) IOS image.

```
interface GigabitEthernet0/1
ip address 192.168.1.2 255.255.255.0
ip access-group 2699 in
!
access-list 2699 deny icmp any 10.10.1.0 0.0.0.255 echo
access-list 2699 deny ip any 10.20.1.0 0.0.0.255
access-list 2699 permit ip any 10.10.1.0 0.0.0.255
access-list 2699 permit tcp any 10.20.1.0 0.0.0.127 eq 22
```

Refer to the exhibit. A network administrator must permit SSH access to remotely manage routers in a network. The operations team resides on the 10.20.1.0/25 network. Which command will accomplish this task?

- `access-list 2699 permit udp 10.20.1.0 0.0.0.255`
- `no access-list 2699 deny tcp any 10.20.1.0 0.0.0.127 eq 22`
- `access-list 2699 permit tcp any 10.20.1.0 0.0.0.255 eq 22`
- `no access-list 2699 deny ip any 10.20.1.0 0.0.0.255`

Snapshots were taken on 23rd September 2021

What is the difference in data transmission delivery and reliability between TCP and UDP?

- UDP is used for multicast and broadcast communication. TCP is used for unicast communication and transmits data at a higher rate with error checking.
- TCP transmits data at a higher rate and ensures packet delivery. UDP retransmits lost data to ensure applications receive the data on the remote end.
- TCP requires the connection to be established before transmitting data. UDP transmits data at a higher rate without ensuring packet delivery.
- UDP sets up a connection between both devices before transmitting data. TCP uses the three-way handshake to transmit data with a reliable connection.

```
R1# show ip route
D    192.168.10.0/24 [90/2679326] via 192.168.1.1
R    192.168.10.0/27 [120/3]   via 192.168.1.2
O    192.168.10.0/23 [110/2]   via 192.168.1.3
i L1 192.168.10.0/13 [115/30]  via 192.168.1.4
```

Refer to the exhibit. How does router R1 handle traffic to 192.168.10.16?

- It selects the EIGRP route because it has the lowest administrative distance.
- It selects the IS-IS route because it has the shortest prefix inclusive of the destination address.
- It selects the RIP route because it has the longest prefix inclusive of the destination address.
- It selects the OSPF route because it has the lowest cost.

```
Switch (config)#hostname R1
R1 (config)#interface FastEthernet0/1
R1 (config-if)#no switchport
R1 (config-if)#ip address 10.100.20.42 255.255.255.0
R1 (config-if)#line vty 0 4
R1 (config-line)#login
```

Refer to the exhibit. An engineer booted a new switch and applied this configuration via the console port. Which additional configuration must be applied to allow administrators to authenticate directly to global configuration mode via Telnet using a local username and password?

- R1 (config)#username admin privilege 15 secret p@ss1234
R1 (config-if)#line vty 0 4
R1 (config-line)#login local
- R1 (config)#username admin
R1 (config-if)#line vty 0 4
R1 (config-line)#password p@ss1234
- R1 (config)#username admin secret p@ss1234
R1 (config-if)#line vty 0 4
R1 (config-line)#login local
R1 (config)#enable secret p@ss1234
- R1 (config)#username admin
R1 (config-if)#line vty 0 4
R1 (config-line)#password p@ss1234
R1 (config-line)#transport input telnet

What is the difference between AAA authentication and authorization?

- Authentication verifies a username and password, and authorization handles the communication between the authentication agent and the user database.
- Authentication identifies and verifies a user who is attempting to access a system, and authorization controls the tasks the user performs.
- Authentication controls the system processes a user accesses, and authorization logs the activities the user initiates.
- Authentication identifies a user who is attempting to access a system, and authorization validates the user's password.

Which protocol does an access point use to draw power from a connected switch?

- Neighbor Discovery Protocol
- Internet Group Management Protocol
- Cisco Discovery Protocol
- Adaptive Wireless Path Protocol

A network engineer must create a diagram of a multivendor network. Which command must be configured on the Cisco devices so that the topology of the network is allowed to be mapped?

- Device(config)#**lldp run**
- Device(config)#**cdp run**
- Device(config-if)#**cdp enable**
- Device(config)#**flow-sampler-map topology**

Which action must be taken to assign a global unicast IPv6 address on an interface that is derived from the MAC address of that interface?

- explicitly assign a link-local address
- configure a stateful DHCPv6 server on the network
- disable the EUI-64 bit process
- enable SLAAC on an interface

Snapshots were taken on 23rd September 2021

Which implementation provides the strongest encryption combination for the wireless environment?

- WEP
- WPA + AES
- WPA2 + AES
- WPA + TKIP

When a WLAN with WPA2 PSK is configured in the Wireless LAN Controller GUI, which format is supported?

- ASCII
- base64
- decimal
- unicode

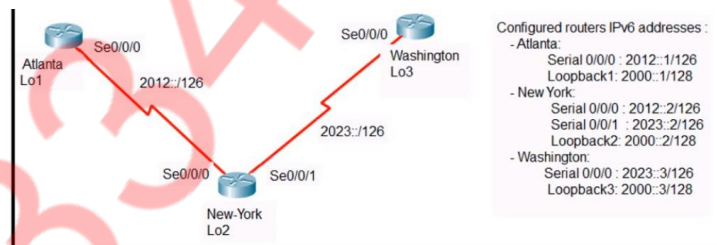

Refer to the exhibit. The New York router is configured with static routes pointing to the Atlanta and Washington sites. Which two tasks must be performed so that the Se0/0/0 interfaces on the Atlanta and Washington routers reach one another? (Choose two.)

- Configure the **ipv6 route 2023::/126 2012::1** command on the Atlanta router.
- Configure the **ipv6 route 2012::/126 2023::1** command on the Washington router.
- Configure the **ipv6 route 2023::/126 2012::2** command on the Atlanta router.
- Configure the **ipv6 route 2012::/126 2023::2** command on the Washington router.
- Configure the **ipv6 route 2012::/126 s0/0/0** command on the Atlanta router.

Snapshots were taken on 23rd September 2021

Refer to the exhibit. An engineer is required to verify that the network parameters are valid for the users wireless LAN connectivity on a /24 subnet. Drag and drop the values from the left onto the network parameters on the right. Not all values are used.

192.168.1.1	broadcast address
192.168.1.20	default gateway
192.168.1.254	host IP address
192.168.1.255	last assignable IP address in the subnet
B8-76-3F-7C-57-DF	MAC address
1A-76-3F-7C-57-DF	network address
192.168.1.0	

B8-76-3F-7C-57-DF
192.168.1.1
192.168.1.20
192.168.1.254
192.168.1.255
1A-76-3F-7C-57-DF
192.168.1.0

An engineer configured an OSPF neighbor as a designated router. Which state verifies the designated router is in the proper mode?

- Exchange
- 2-way
- Init
- Full

Snapshots were taken on 23rd September 2021

What are two benefits of controller-based networking compared to traditional networking? (Choose two.)

- controller-based inflates software costs, while traditional decreases individual licensing costs
- controller-based allows for fewer network failures, while traditional increases failure rates
- controller-based reduces network configuration complexity, while traditional increases the potential for errors
- controller-based increases network bandwidth usage, while traditional lightens the load on the network
- controller-based provides centralization of key IT functions, while traditional requires distributed management functions



Refer to the exhibit. After the configuration is applied, the two routers fail to establish an OSPF neighbor relationship. What is the reason for the problem?

- The OSPF process IDs are mismatched.
- Router2 is using the default hello timer.
- The network statement on Router1 is misconfigured.
- The OSPF router IDs are mismatched.

Which two components are needed to create an Ansible script that configures a VLAN on a switch? (Choose two.)

- cookbook
- recipe
- task
- playbook
- model

Snapshots were taken on 23rd September 2021

A network administrator is asked to configure VLANs 2, 3, and 4 for a new implementation. Some ports must be assigned to the new VLANs with unused ports remaining. Which action should be taken for the unused ports?

- configure in a nondefault native VLAN
- configure ports as access ports
- configure ports in the native VLAN
- configure ports in a black hole VLAN

What is a characteristic of cloud-based network topology?

- physical workstations are configured to share resources
- onsite network services are provided with physical Layer 2 and Layer 3 components
- services are provided by a public, private, or hybrid deployment
- wireless connections provide the sole access method to services

Which level of severity must be set to get informational syslogs?

- alert
- critical
- notice
- debug

Which access layer threat-mitigation technique provides security based on identity?

- Dynamic ARP Inspection
- 802.1x
- DHCP snooping
- using a non-default native VLAN

Snapshots were taken on 23rd September 2021

A network administrator must enable DHCP services between two sites. What must be configured for the router to pass DHCPDISCOVER messages on to the server?

- a DHCP Pool
- a DHCP Relay Agent
- DHCP Snooping
- DHCP Binding

```
10.0.0.0/24 is subsetting, 1 subnets
C    10.0.0.0 is directly connected, FastEthernet0/1
C    172.160.0/16 is directly connected, FastEthernet0/0
D    192.168.0.0/24 [90/30720] via 172.16.0.2, 00:00:03, FastEthernet0/0
```

Refer to the exhibit. Which route type does the routing protocol Code D represent in the output?

- route learned through EIGRP
- internal BGP route
- statically assigned route
- /24 route of a locally configured IP

The SW1 interface g0/1 is in the down/down state. What are two reasons for the interface condition? (Choose two.)

- There is a duplex mismatch.
- There is a speed mismatch.
- The interface is shut down.
- There is a protocol mismatch.
- The interface is error-disabled.

```
SW2
vtp domain cisco
vtp mode transparent
vtp password ciscotest
interface fastethernet0/1
  description connection to sw1
  switchport mode trunk
  switchport trunk encapsulation dot1q
```

Refer to the exhibit. How does SW2 interact with other switches in this VTP domain?

- It transmits and processes VTP updates from any VTP clients on the network on its trunk ports.
- It processes VTP updates from any VTP clients on the network on its access ports.
- It forwards only the VTP advertisements that it receives on its trunk ports.
- It receives updates from all VTP servers and forwards all locally configured VLANs out all trunk ports.

Snapshots were taken on 23rd September 2021

Which virtual MAC address is used by VRRP group 1?

- 0500.4.0636.5421
- 0007.c061.bc01
- 0050.0c05.ad81
- 0000.5E00.0101

How do TCP and UDP differ in the way they guarantee packet delivery?

- TCP uses checksum, acknowledgements, and retransmissions, and UDP uses checksums only.
- TCP uses retransmissions, acknowledgement, and parity checks, and UDP uses cyclic redundancy checks only.
- TCP uses checksum, parity checks, and retransmissions, and UDP uses acknowledgements only.
- TCP uses two-dimensional parity checks, checksums, and cyclic redundancy checks, and UDP uses retransmissions only.

On workstations running Microsoft Windows, which protocol provides the default gateway for the device?

- DNS
- SNMP
- STP
- DHCP

Snapshots were taken on 23rd September 2021

What is the purpose of using First Hop Redundancy Protocol on a specific subnet?

- sends the default route to the hosts on a network
- filters traffic based on destination IP addressing
- forwards multicast hello messages between routers
- ensures a loop-free physical topology

Router R1 must send all traffic without a matching routing-table entry to 192.168.1.1. Which configuration accomplishes this task?

- R1#config t
R1(config)#ip routing
R1(config)#ip route 0.0.0.0 0.0.0.0 192.168.1.1
- R1#config t
R1(config)#ip routing
R1(config)#ip route default-route 192.168.1.1
- R1#config t
R1(config)#ip routing
R1(config)#ip route 192.168.1.1 0.0.0.0 0.0.0.0
- R1#config t
R1(config)#ip routing
R1(config)#ip default-gateway 192.168.1.1

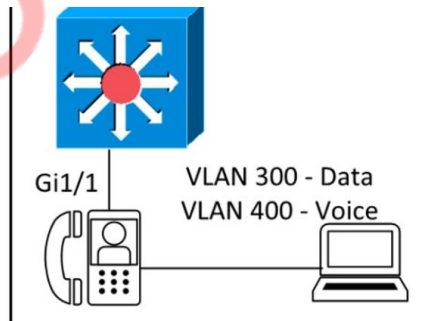

Refer to the exhibit. An engineer must configure GigabitEthernet1/1 to accommodate voice and data traffic. Which configuration accomplishes this task?

- interface gigabitEthernet1/1
switchport mode access
switchport voice vlan 300
switchport access vlan 400
- interface gigabitEthernet1/1
switchport mode trunk
switchport trunk vlan 300
switchport voice vlan 400
- interface gigabitEthernet1/1
switchport mode access
switchport access vlan 300
switchport voice vlan 400
- interface gigabitEthernet1/1
switchport mode trunk
switchport trunk vlan 300
switchport trunk vlan 400

In QoS, which prioritization method is appropriate for interactive voice and video?

- round-robin scheduling
- low-latency queuing
- expedited forwarding
- traffic policing

Which feature on the Cisco Wireless LAN Controller when enabled restricts management access from specific networks?

- Flex ACL
- CPU ACL
- RADIUS
- TACACS

A Cisco IP phone receives untagged data traffic from an attached PC. Which action is taken by the phone?

- It drops the traffic.
- It allows the traffic to pass through unchanged.
- It tags the traffic with the native VLAN.
- It tags the traffic with the default VLAN.

Which output displays a JSON data representation?

{
 "response"- {
 "taskId"- {},
 "url"- "string"
 },
 "version"- "string"
}

{
 "response": {
 "taskId": {};
 "url": "string"
 };
 "version": "string"
}

{
 "response": {
 "taskId": {},
 "url": "string"
 },
 "version": "string"
}

{
 "response", {
 "taskId", {};
 "url", "string"
 };
 "version", "string"
}

Snapshots were taken on 23rd September 2021

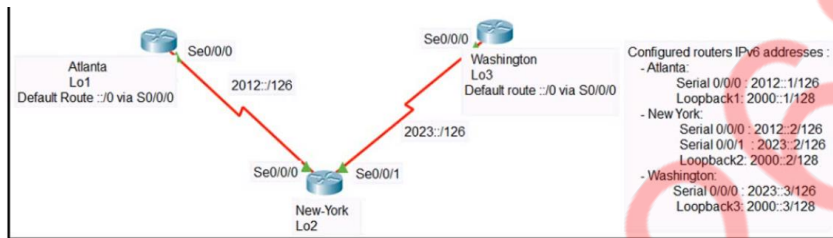

Refer to the exhibit. The loopback1 interface of the Atlanta router must reach the loopback3 interface of the Washington router. Which two static host routes must be configured on the New York router? (Choose two.)

- ipv6 route 2000::1/128 s0/0/1
- ipv6 route 2000::3/128 2023::3
- ipv6 route 2000::1/128 2012::1
- ipv6 route 2000::1/128 2012::2
- ipv6 route 2000::3/128 s0/0/0

What is an advantage of Cisco DNA Center versus traditional campus device management?

- It is designed primarily to provide network assurance.
- It enables easy autodiscovery of network elements in a brownfield deployment.
- It supports high availability for management functions when operating in cluster mode.
- It supports numerous extensibility options, including cross-domain adapters and third-party SDKs.

EIGRP: 192.168.12.0/24
RIP: 192.168.12.0/27
OSPF: 192.168.12.0/28

Refer to the exhibit. How does the router manage traffic to 192.168.12.16?

- It selects the RIP route because it has the longest prefix inclusive of the destination address.
- It chooses the OSPF route because it has the longest prefix inclusive of the destination address.
- It chooses the EIGRP route because it has the lowest administrative distance.
- It load-balances traffic between all three routes.

Snapshots were taken on 23rd September 2021

Which two command sequences must be configured on a switch to establish a Layer 3 EtherChannel with an open-standard protocol? (Choose two.)

- interface GigabitEthernet0/0/1
channel-group 10 mode auto
- interface GigabitEthernet0/0/1
channel-group 10 mode active
- interface port-channel 10
no switchport
ip address 172.16.0.1 255.255.255.0
- interface GigabitEthernet0/0/1
channel-group 10 mode on
- interface port-channel 10
switchport
switchport mode trunk

How do AAA operations compare regarding user identification, user services, and access control?

- Authorization identifies users, and authentication provides access control.
- Accounting tracks user services, and authentication provides access control.
- Authentication identifies users, and accounting tracks user services.
- Authorization provides access control, and authentication tracks user services.

What is the expected outcome when an EUI-64 address is generated?

- The MAC address of the interface is used as the interface ID without modification.
- The seventh bit of the original MAC address of the interface is inverted.
- The interface ID is configured as a random 64-bit value.
- The characters FE80 are inserted at the beginning of the MAC address of the interface.

Which configuration is needed to generate an RSA key for SSH on a router?

- Configure the version of SSH.
- Assign a DNS domain name.
- Create a user with a password.
- Configure VTY access.

What is a difference between local AP mode and FlexConnect AP mode?

- FlexConnect AP mode bridges the traffic from the AP to the WLC when local switching is configured.
- Local AP mode creates two CAPWAP tunnels per AP to the WLC.
- FlexConnect AP mode fails to function if the AP loses connectivity with the WLC.
- Local AP mode causes the AP to behave as if it were an autonomous AP.

By default, how does EIGRP determine the metric of a route for the routing table?

- It uses a default metric of 10 for all routes that are learned by the router.
- It counts the number of hops between the receiving and destination routers and uses that value as the metric.
- It uses a reference bandwidth and the actual bandwidth of the connected link to calculate the route metric.
- It uses the bandwidth and delay values of the path to calculate the route metric.

Which two encoding methods are supported by REST APIs? (Choose two.)

- XML
- SGML
- JSON
- YAML
- EBCDIC

Drag and drop the SNMP components from the left onto the descriptions on the right.

MIB	collection of variables that can be monitored
SNMP agent	unsolicited message
SNMP manager	responds to status requests and requests for information about a device
SNMP trap	resides on an NMS

MIB
SNMP trap
SNMP agent
SNMP manager

Snapshots were taken on 23rd September 2021

Which type of IPv6 address is publicly routable in the same way as IPv4 public addresses?

- link-local
- global unicast
- unique local
- multicast

Which network action occurs within the data plane?

- run routing protocols (OSPF, EIGRP, RIP, BGP)
- compare the destination IP address to the IP routing table
- make a configuration change from an incoming NETCONF RPC
- reply to an incoming ICMP echo request

What are two reasons that cause late collisions to increment on an Ethernet interface? (Choose two.)

- when the cable length limits are exceeded
- when Carrier Sense Multiple Access/Collision Detection is used
- when a collision occurs after the 32nd byte of a frame has been transmitted
- when the sending device waits 15 seconds before sending the frame again
- when one side of the connection is configured for half-duplex

Snapshots were taken on 23rd September 2021

```
R1#show running-config
Building configuration...
!
interface GigabitEthernet1/0
  mtu 1600
  ip address 192.168.0.1 255.255.255.252
  negotiation auto
!
router ospf 1
  router-id 1.1.1.1
  passive-interface default
  no passive-interface GigabitEthernet1/0
  network 192.168.0.1 0.0.0.0 area 0
!
R2#show running-config
Building configuration...
!
interface GigabitEthernet2/0
  ip address 192.168.0.2 255.255.255.252
  negotiation auto
!
router ospf 1
  router-id 2.2.2.2
  passive-interface default
  no passive-interface GigabitEthernet2/0
  network 192.168.0.2 0.0.0.0 area 0
```

Refer to the exhibit. Which configuration issue is preventing the OSPF neighbor relationship from being established between the two routers?

- R1 has an incorrect **network** command for interface Gi1/0.
- R2 is using the **passive-interface default** command.
- R1 interface Gi1/0 has a larger MTU size.
- R2 should have its **network** command in area 1.

A corporate office uses four floors in a building.

- Floor 1 has 24 users.
- Floor 2 has 29 users.
- Floor 3 has 28 users.
- Floor 4 has 22 users.

Which subnet summarizes and gives the most efficient distribution of IP addresses for the router configuration?

- 192.168.0.0/25 as summary and 192.168.0.0/27 for each floor
- 192.168.0.0/26 as summary and 192.168.0.0/29 for each floor
- 192.168.0.0/23 as summary and 192.168.0.0/25 for each floor
- 192.168.0.0/24 as summary and 192.168.0.0/28 for each floor

Snapshots were taken on 23rd September 2021

What is a function of TFTP in network operations?

- transfers files between file systems on a router
- transfers IOS images from a server to a router for firmware upgrades
- transfers a backup configuration file from a server to a switch using a username and password
- transfers a configuration files from a server to a router on a congested link

How does the dynamically-learned MAC address feature function?

- The ports are restricted and learn up to a maximum of 10 dynamically-learned addresses
- The CAM table is empty until ingress traffic arrives at each port.
- Switches dynamically learn MAC addresses of each connecting CAM table.
- It requires a minimum number of secure MAC addresses to be filled dynamically.

An engineer needs to configure LLDP to send the port description type length value (TLV). Which command sequence must be implemented?

- switch(config-line)#lldp port-description
- switch(config-if)#lldp port-description
- switch#lldp port-description
- switch(config)#lldp port-description

Snapshots were taken on 23rd September 2021

```
SW1(config-line)#line vty 0 15
SW1(config-line)#no login local
SW1(config-line)#password cisco

SW2(config)#username admin1 password abcd1234
SW2(config)#username admin2 password abcd1234
SW2(config-line)#line vty 0 15
SW2(config-line)#login local

SW3(config)#username admin1 secret abcd1234
SW3(config)#username admin2 secret abcd1234
SW3(config-line)#line vty 0 15
SW3(config-line)#login local

SW4(config)#username admin1 secret abcd1234
SW4(config)#username admin2 secret abcd1234
SW4(config-line)#line console 0
SW4(config-line)#login local
```

Refer to the exhibit. An administrator configures four switches for local authentication using passwords that are stored as a cryptographic hash. The four switches must also support SSH access for administrators to manage the network infrastructure. Which switch is configured correctly to meet these requirements?

- SW1
- SW2
- SW3
- SW4

```
Gateway of last resort is 10.12.0.1 to network 0.0.0.0

O*E2 0.0.0.0/0 [110/1] via 10.12.0.1, 00:00:01, GigabitEthernet0/0
     10.0.0.0/8 is variably subnetted, 2 subnets, 2 masks
     C   10.0.0.0/24 is directly connected, GigabitEthernet0/0
     L   10.0.0.2/32 is directly connected, GigabitEthernet0/0
     C   10.13.0.0/24 is directly connected, GigabitEthernet0/1
     L   10.13.0.2/32 is directly connected, GigabitEthernet0/1
```

Refer to the exhibit. If configuring a static default route on the router with the `ip route 0.0.0.0 0.0.0.0 10.13.0.1 120` command, how does the router respond?

- It ignores the new static route until the existing OSPF default route is removed.
- It starts load-balancing traffic between the two default routes.
- It immediately replaces the existing OSPF route in the routing table with the newly configured static route.
- It starts sending traffic without a specific matching entry in the routing table to GigabitEthernet0/1.

When the active router in an HSRP group fails, which router assumes the role and forwards packets?

- backup
- forwarding
- listening
- standby

Snapshots were taken on 23rd September 2021

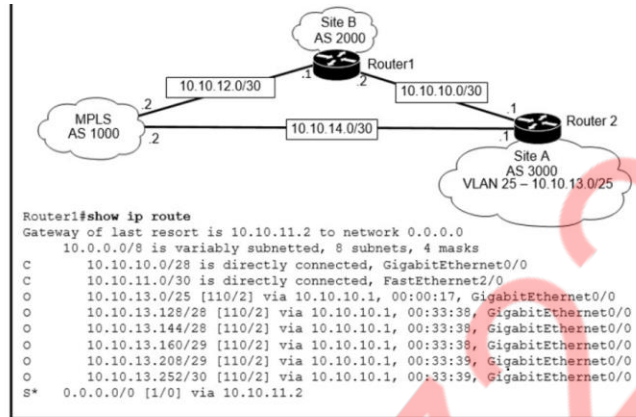

Refer to the exhibit. An engineer is bringing up a new circuit to the MPLS provider on the Gi0/1 interface of Router1. The new circuit uses eBGP and learns the route to VLAN25 from the BGP path. What is the expected behavior for the traffic flow for route 10.10.13.0/25?

- Route 10.10.13.0/25 learned via the Gi0/0 interface remains in the routing table.
- Traffic to 10.10.13.0/25 is load balanced out of multiple interfaces.
- Route 10.10.13.0/25 is updated in the routing table as being learned from interface Gi0/1.
- Traffic to 10.10.13.0/25 is asymmetrical.

A wireless administrator has configured a WLAN; however, the clients need access to a less congested 5-GHz network for their voice quality. Which action must be taken to meet the requirement?

- enable DTIM
- enable Band Select
- enable RX-SOP
- enable AAA override

What are two similarities between UTP Cat 5e and Cat 6a cabling? (Choose two.)

- Both operate at a frequency of 500 MHz.
- Both support runs of up to 100 meters.
- Both support runs of up to 55 meters.
- Both support speeds of at least 1 Gigabit.
- Both support speeds up to 10 Gigabit.

Snapshots were taken on 23rd September 2021

Which WPA3 enhancement protects against hackers viewing traffic on the Wi-Fi network?

- scrambled encryption key
- SAE encryption
- AES encryption
- TKIP encryption

What are two reasons for an engineer to configure a floating static route? (Choose two.)

- to support load balancing via static routing
- to route traffic differently based on the source IP of the packet
- to automatically route traffic on a secondary path when the primary path goes down
- to control the return path of traffic that is sent from the router
- to enable fallback static routing when the dynamic routing protocol fails

What are two characteristics of a controller-based network? (Choose two.)

- It decentralizes the control plane, which allows each device to make its own forwarding decisions.
- It uses northbound and southbound APIs to communicate between architectural layers.
- It uses Telnet to report system issues.
- The administrator can make configuration updates from the CLI.
- It moves the control plane to a central point.

Snapshots were taken on 23rd September 2021

```
SW1#show run int gig 0/1
interface GigabitEthernet0/1
switchport access vlan 11
switchport trunk allowed vlan 1-10
switchport trunk encapsulation dot1q
switchport trunk native vlan 5
switchport mode trunk
speed 1000
duplex full
```

Refer to the exhibit. Which action is expected from SW1 when the untagged frame is received on the GigabitEthernet0/1 Interface?

- The frame is processed in VLAN 11.
- The frame is processed in VLAN 5.
- The frame is processed in VLAN 1.
- The frame is dropped.

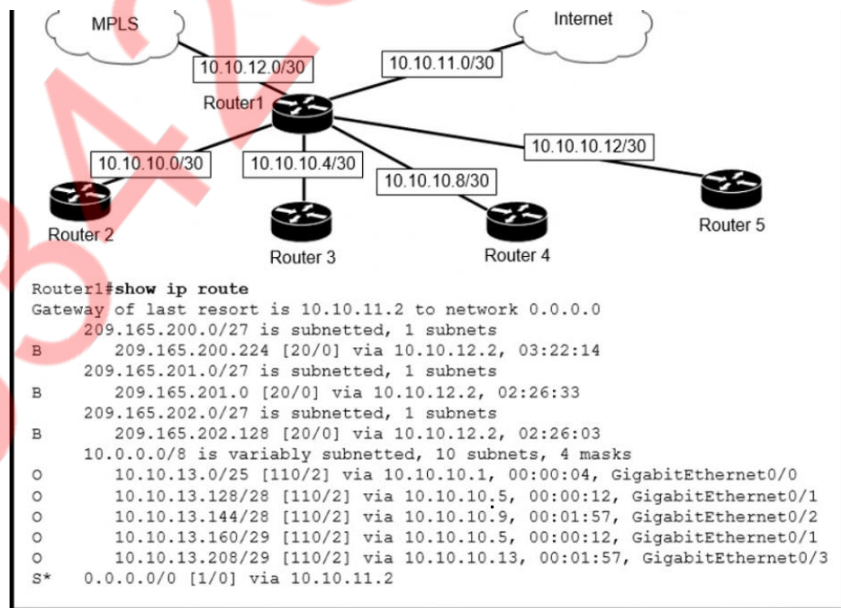

Refer to the exhibit. To which device does Router1 send packets that are destined to host 10.10.13.165?

- Router2
- Router3
- Router4
- Router5

Snapshots were taken on 23rd September 2021

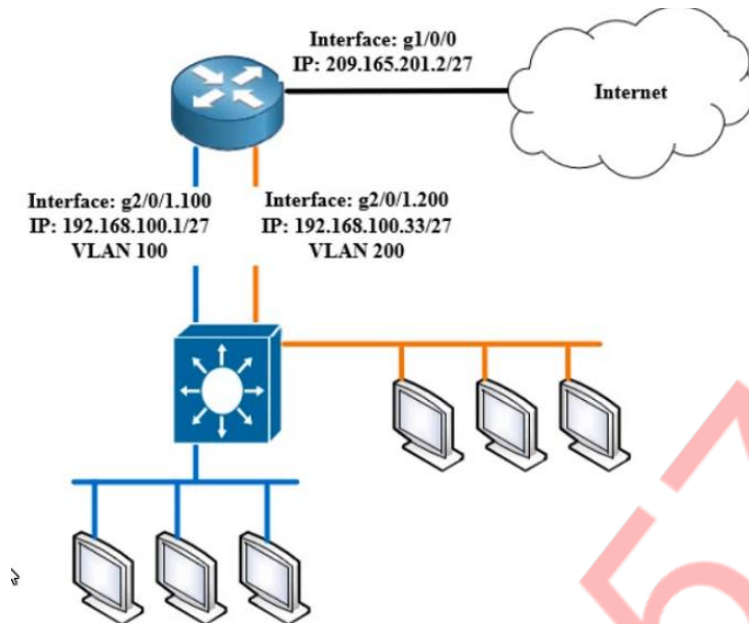

Refer to the exhibit. Which configuration must be applied to the router that configures PAT to translate all addresses in VLAN 200 while allowing devices on VLAN 100 to use their own IP addresses?

- Router1(config)#access-list 99 permit 192.168.100.32 0.0.0.31
Router1(config)#ip nat inside source list 99 interface gi1/0/0 overload
Router1(config)#interface gi2/0/1.200
Router1(config-if)#ip nat inside
Router1(config)#interface gi1/0/0
Router1(config-if)#ip nat outside
- Router1(config)#access-list 99 permit 209.165.201.2 0.0.0.0
Router1(config)#ip nat inside source list 99 interface gi1/0/0 overload
Router1(config)#interface gi2/0/1.200
Router1(config-if)#ip nat inside
Router1(config)#interface gi1/0/0
Router1(config-if)#ip nat outside
- Router1(config)#access-list 99 permit 209.165.201.2 255.255.255.255
Router1(config)#ip nat inside source list 99 interface gi1/0/0 overload
Router1(config)#interface gi2/0/1.200
Router1(config-if)#ip nat inside
Router1(config)#interface gi1/0/0
Router1(config-if)#ip nat outside
- Router1(config)#access-list 99 permit 192.168.100.0 0.0.0.255
Router1(config)#ip nat inside source list 99 interface gi1/0/0 overload
Router1(config)#interface gi2/0/1.200
Router1(config-if)#ip nat inside
Router1(config)#interface gi1/0/0
Router1(config-if)#ip nat outside

How does CAPWAP communicate between an access point in local mode and a WLC?

- The access point has the ability to link to any switch in the network, assuming connectivity to the WLC.
- The access point must be connected to the same switch as the WLC.
- The access point must not be connected to the wired network, as it would create a loop.
- The access point must directly connect to the WLC using a copper cable.

Snapshots were taken on 23rd September 2021

An office has 8 floors with approximately 30-40 users per floor. One subnet must be used. Which command must be configured on the router Switched Virtual Interface to use address space efficiently?

- ip address 192.168.0.0 255.255.0.0
- ip address 192.168.0.0 255.255.254.0
- ip address 192.168.0.0 255.255.255.128
- ip address 192.168.0.0 255.255.255.224

```
R2#show ip route
C 192.168.1.0/26 is directly connected, FastEthernet0/1
```

Refer to the exhibit. Which two prefixes are included in this routing table entry? (Choose two.)

- 192.168.1.17
- 192.168.1.61
- 192.168.1.64
- 192.168.1.127
- 192.168.1.254

Which two values or settings must be entered when configuring a new WLAN in the Cisco Wireless LAN Controller GUI? (Choose two.)

- QoS settings
- management interface settings
- IP address of one or more access points
- profile name
- SSID

```
ip arp inspection vlan 2
interface fastethernet 0/1
 switchport mode access
 switchport access vian 2
```

Refer to the exhibit. What is the effect of this configuration?

- The switch port remains down until it is configured to trust or untrust incoming packets.
- The switch port remains administratively down until the interface is connected to another switch.
- Dynamic ARP Inspection is disabled because the ARP ACL is missing.
- The switch port interface trust state becomes untrusted.

Snapshots were taken on 23rd September 2021

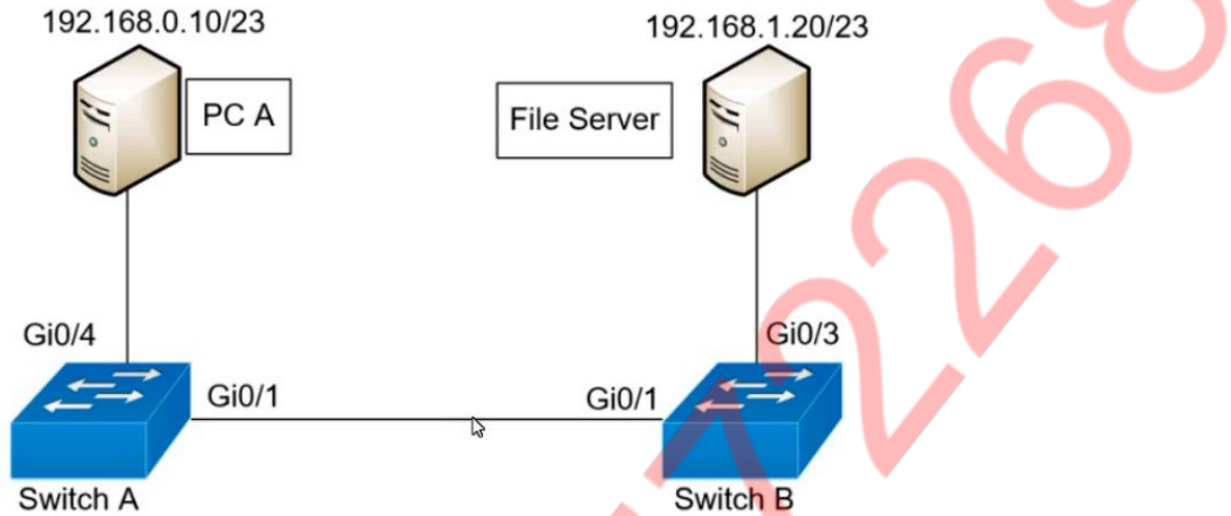

Switch A

Vlan 10,11,12,13

```
interface GigabitEthernet0/1
  switchport mode trunk
  switchport trunk allowed vlan 10-12
  !
interface GigabitEthernet0/4
  switchport access vlan 13
  switchport mode access
```

Switch B

Vlan 10,11,12,13

```
interface GigabitEthernet0/1
  switchport mode trunk
  !
interface GigabitEthernet0/3
  switchport access vlan 13
  switchport mode access
```

Refer to the exhibit. A network engineer must configure communication between PC A and the File Server. To prevent interruption for any other communications, which command must be configured?

- switchport trunk allowed vlan 12
- switchport trunk allowed vlan none
- switchport trunk allowed vlan add 13
- switchport trunk allowed vlan remove 10-11

Which set of actions satisfy the requirement for multifactor authentication?

- The user swipes a key fob, then clicks through an email link.
- The user enters a user name and password, and then clicks a notification in an authentication app on a mobile device.
- The user enters a PIN into an RSA token, and then enters the displayed RSA key on a login screen.
- The user enters a user name and password, and then re-enters the credentials on a second screen.

Snapshots were taken on 23rd September 2021

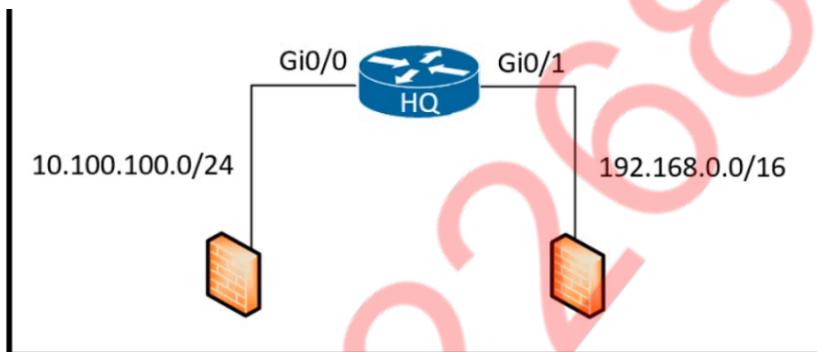

Refer to the exhibit. An access-list is required to permit traffic from any host on interface Gi0/0 and deny traffic from interface Gi0/1. Which access list must be applied?

- ip access-list standard 99
permit 10.100.100.0 0.0.0.255
deny 192.168.0.0 0.0.255.255
- ip access-list standard 99
permit 10.100.100.0 0.0.0.255
deny 192.168.0.0 0.255.255.255
- ip access-list standard 199
permit 10.100.100.0 0.0.0.255
deny 192.168.0.0 0.255.255.255
- ip access-list standard 199
permit 10.100.100.0 0.0.0.255
deny 192.168.0.0 0.0.255.255

```
ip arp inspection vlan 2-10
interface fastethernet 0/1
ip arp inspection trust
```

Refer to the exhibit. If the network environment is operating normally, which type of device must be connected to interface fastethernet 0/1?

- PC
- DHCP client
- access point
- router

Snapshots were taken on 23rd September 2021

Drag and drop the Cisco Wireless LAN Controller security settings from the left onto the correct security mechanism categories on the right.

web policy

Passthrough

WPA+WPA2

802.1X

Layer 2 Security Mechanisms

Layer 3 Security Mechanisms (for WLAN)

Layer 2 Security Mechanisms

WPA+WPA2

802.1X

Layer 3 Security Mechanisms (for WLAN)

web policy

Passthrough

What occurs when PortFast is enabled on an interface that is connected to another switch?

- VTP is allowed to propagate VLAN configuration information from switch to switch automatically.
- Spanning-tree fails to detect a switching loop increasing the likelihood of broadcast storms.
- After spanning-tree converges, PortFast shuts down any port that receives BPDUs.
- Root port choice and spanning-tree recalculation are accelerated when a switch link goes down.

Snapshots were taken on 23rd September 2021

What is a function of a remote access VPN?

- uses cryptographic tunneling to protect the privacy of data for multiple users simultaneously
- used exclusively when a user is connected to a company's internal network
- allows the users to access company internal network resources through a secure tunnel
- establishes a secure tunnel between two branch sites

```
switch(config)#interface gigabitEthernet 1/11
switch(config-if)#switchport mode access
switch(config-if)#spanning-tree portfast
switch(config-if)#spanning-tree bpduguard enable
```

Refer to the exhibit. What is the result if Gig1/11 receives an STP BPDU?

- The port goes into error-disable state.
- The port transitions to STP blocking.
- The port immediately transitions to STP forwarding.
- The port transitions to the root port.

```
R1# show ip route
```

```
D    192.168.16.0/26 [90/2679326] via 192.168.1.1
R    192.168.16.0/24 [120/3] via 192.168.1.2
O    192.168.16.0/21 [110/2] via 192.168.1.3
i L1 192.168.16.0/27 [115/30] via 192.168.1.4
```

Refer to the exhibit. Which route does R1 select for traffic that is destined to 192.168.16.2?

- 192.168.16.0/21
- 192.168.16.0/24
- 192.168.16.0/26
- 192.168.16.0/27

Snapshots were taken on 23rd September 2021

Which goal is achieved by the implementation of private IPv4 addressing on a network?

- provides a reduction in size of the forwarding table on network routers
- allows communication across the Internet to other private networks
- provides an added level of protection against Internet exposure
- allows servers and workstations to communicate across public network boundaries

```
Router#show ip route
Codes: L - local, C - connected, S - static, R - RIP, M - mobile, B - BGP
       D - EIGRP, EX - EIGRP external, O - OSPF, IA - OSPF inter area
       N1 - OSPF NSSA external type 1, N2 - OSPF NSSA external type 2
       E1 - OSPF external type 1, E2 - OSPF external type 2
       i - IS-IS, su - IS-IS summary, L1 - IS-IS level-1, L2 - IS-IS level-2
       ia - IS-IS inter area, * - candidate default, U - per-user static route

Gateway of last resort is 209.165.202.131 to network 0.0.0.0

S*   0.0.0.0/0 [1/0] via 209.165.202.131
     209.165.200.0/27 is subnetted, 1 subnets
S    209.165.200.224 [254/0] via 209.165.202.129
     209.165.201.0/27 is subnetted, 1 subnets
S    209.165.201.0 [1/0] via 209.165.202.130
```

Refer to the exhibit. Which command configures a floating static route to provide a backup to the primary link?

- ip route 0.0.0.0 0.0.0.0 209.165.202.131
- ip route 209.165.201.0 255.255.255.224 209.165.202.130
- ip route 209.165.200.224 255.255.255.224 209.165.202.129 254
- ip route 0.0.0.0 0.0.0.0 209.165.200.224