

CCNA – Basic Questions

<http://www.9tut.com/basic-questions>

Question 1

Which network topology allows all traffic to flow through a central hub?

- A. bus
- B. star
- C. mesh
- D. ring

Answer: B

Question 2

What is true about Ethernet? (Choose two)

- A. 802.2 Protocol
- B. 802.3 Protocol
- C. 10BaseT half duplex
- D. CSMA/CD stops transmitting when congestion occurs
- E. CSMA/CA stops transmitting when congestion occurs

Answer: B D

Question 3

If a router has 3 hosts connected in one port and two other hosts connected in another port, how many broadcast domains are present on the router?

- A. 5
- B. 2
- C. 3
- D. 4

Answer: B

Question 4

On which type of device is every port in the same collision domain?

- A. a router
- B. a Layer 2 switch
- C. a hub

Answer: C

Question 5

Which MTU size can cause a baby giant error?

- A. 1500
- B. 9216
- C. 1600
- D. 1518

Answer: D

Question 6

What are three characteristics of the TCP protocol? (Choose three)

- A. The connection is established before data is transmitted.
- B. It uses a single SYN-ACK message to establish a connection.
- C. It ensures that all data is transmitted and received by the remote device.
- D. It uses separate SYN and ACK messages to establish a connection.
- E. It supports significantly higher transmission speeds than UDP.
- F. It requires applications to determine when data packets must be retransmitted.

Answer: A C D

Question 7

Which of the following statements describe the network shown in the graphic? (Choose two)

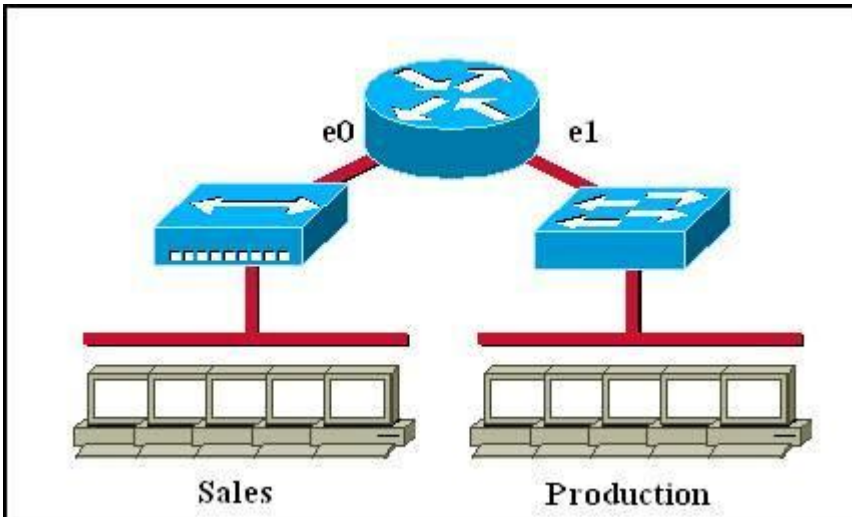

- A. There are two broadcast domains in the network.
- B. There are four broadcast domains in the network.
- C. There are six broadcast domains in the network.
- D. There are four collision domains in the network.
- E. There are five collision domains in the network.
- F. There are seven collision domains in the network.

Answer: A F

Question 8

A network interface port has collision detection and carrier sensing enabled on a shared twisted pair network. From this statement, what is known about the network interface port?

- A. This is a 10 Mb/s switch port.
- B. This is a 100 Mb/s switch port.
- C. This is an Ethernet port operating at half duplex.
- D. This is an Ethernet port operating at full duplex.
- E. This is a port on a network interface card in a PC.

Answer: C

Question 9

If there are 3 hosts connected in one port of a switch and two other hosts connected in another port, how many collision domains are present on the router?

- A. 5
- B. 2
- C. 3
- D. 4

Answer: B

Question 10

What are contained in Layer 2 Ethernet frame? (Choose three)

- A. Preamble
- B. TTL
- C. Type/length
- D. Frame check sequence
- E. version
- F. others

Answer: A C D

Basic Questions 2

<http://www.9tut.com/basic-questions-2>

Question 1

What interconnection cable can you use when you use a MDI connection?

- A. cut-through
- B. straight-through
- C. crossover
- D. rollover

Answer: C

Question 2

For what two purposes does the Ethernet protocol use physical addresses? (Choose two)

- A. to uniquely identify devices at Layer 2
- B. to allow communication with devices on a different network
- C. to differentiate a Layer 2 frame from a Layer 3 packet
- D. to establish a priority system to determine which device gets to transmit first
- E. to allow communication between different devices on the same network
- F. to allow detection of a remote device when its physical address is unknown

Answer: A E

Question 3

In an Ethernet network, under what two scenarios can devices transmit? (Choose two)

- A. when they receive a special token
- B. when there is a carrier
- C. when they detect no other devices are sending
- D. when the server grants access
- E. when the medium is idle

Answer: C E

Question 4

How many broadcast domains are shown in the graphic assuming only the default VLAN is configured on the switches?

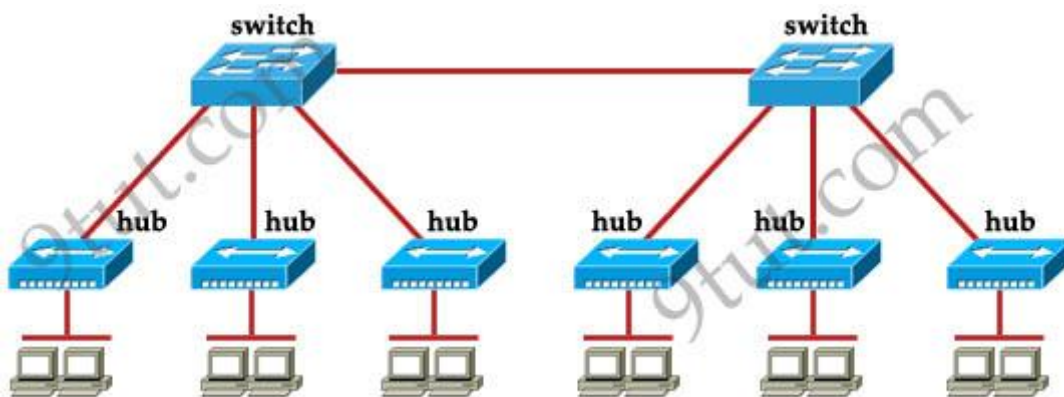

- A. one
- B. six
- C. twelve
- D. two

Answer: A

Question 5

Which type of cable must you use to connect two device with MDI interfaces?

- A. rolled
- B. crossover
- C. crossed
- D. straight through

Answer: B

Question 6

Which statement about upgrading a Cisco IOS device with TFTP server?

- A. the operation is performed in active mode
- B. the operation is performed in unencrypted format
- C. the operation is performed in passive mode
- D. the Cisco IOS device must be on the same LAN as the TFTP server

Answer: B

Question 7

Which two options are fields in an Ethernet frame? (Choose two)

- A. frame check sequence
- B. header
- C. source IP address
- D. destination IP address
- E. type

Answer: A E

Question 8

Which two statements about UDP are true? (Choose two)

- A. It can transmit data at a rate higher than the path capacity
- B. It uses a three-way handshake to ensure that traffic is transmitted properly
- C. It guarantees packet delivery
- D. It includes protection against duplicate packets
- E. It can be used for multicast and broadcast traffic

Answer: A E

OSI TCP/IP Model Questions

<http://www.9tut.com/osi-model-questions>

Question 1

Which statements correctly describe steps in the OSI data encapsulation process?

- A. The transport layer divides a data stream into segments and may add reliability and flow control information.
- B. The data link layer adds physical source and destination addresses and an FCS to the segment.
- C. Packets are created when the network layer encapsulates a frame with source and destination host addresses and protocol-related control information.
- D. Packets are created when the network layer adds Layer 3 addresses and control information to a segment.
- E. The presentation layer translates bits into voltages for transmission across the physical link.

Answer: A D

Question 2

What layer of the OSI Model is included in TCP/IP Model's INTERNET layer?

- A. Application
- B. Session
- C. Data Link
- D. Presentation
- E. Network

Answer: E

Question 3

Where does routing occur within the DoD TCP/IP reference model?

- A. application
- B. internet
- C. network
- D. transport

Answer: B

Question 4

Which of the following correctly describe steps in the OSI data encapsulation process? (Choose two)

- A. The transport layer divides a data stream into segments and may add reliability and flow control information.

- B. The data link layer adds physical source and destination addresses and an FCS to the segment.
- C. Packets are created when the network layer encapsulates a frame with source and destination host addresses and protocol-related control information.
- D. Packets are created when the network layer adds Layer 3 addresses and control information to a segment.
- E. The presentation layer translates bits into voltages for transmission across the physical link.

Answer: A D

Question 5

Which layer in the OSI reference model is responsible for determining the availability of the receiving program and checking to see if enough resources exist for that communication?

- A. transport
- B. network
- C. presentation
- D. session
- E. application

Answer: E

Question 6

Which networking technology is currently recognized as the standard for computer networking?

- A. System network architecture
- B. Transmission control protocol/Internet protocol
- C. Open system Interconnect
- D. Open network architecture

Answer: B

Question 7

Which three encapsulation layers in the OSI model are combined into the TCP/IP application layer?
(Choose three)

- A. Session
- B. Transport
- C. Presentation
- D. Application
- E. Data-link
- F. Network

Answer: A C D

Cloud & Virtual Services

<http://www.9tut.com/cloud-virtual-services>

Question 1

Which option is the benefit of implementing an intelligent DNS for a cloud computing solution?

- A. It reduces the need for a backup data center.
- B. It can redirect user requests to locations that are using fewer network resources.
- C. It enables the ISP to maintain DNS records automatically.
- D. It eliminates the need for a GSS.

Answer: B

Question 2

What are the three major components of Cisco network virtualization? (Choose three)

- A. network access control
- B. path isolation
- C. virtual network services
- D. policy enforcement

Answer: A B C

Question 3

Which three technical services support cloud computing?

- A. network-monitored power sources
- B. layer 3 network routing
- C. ip localization
- D. redundant connections
- E. VPN connectivity
- F. extended SAN services

Answer: D E F

Question 4

Which major component of the network virtualization architecture isolate users according to policy?

- A. policy enforcement
- B. network access control
- C. network services virtualization
- D. other

Answer: B

Question 5

Which three options are the major components of a network virtualization architecture? (Choose three)

- A. virtual network services
- B. authentication services
- C. network access control
- D. network resilience
- E. path isolation
- F. policy enforcement

Answer: A C E

Question 6

Which cloud service is typically used to provide DNS and DHCP services to an enterprise?

- A. IaaS
- B. DaaS
- C. SaaS
- D. PaaS

Answer: A

WAN Questions

<http://www.9tut.com/wan-questions>

Question 1

Which command can you enter to determine whether serial interface 0/2/0 has been configured using HDLC encapsulation?

- A. router#show platform
- B. router#show ip interface s0/2/0
- C. router#show interfaces Serial 0/2/0
- D. router#show ip interface brief

Answer: C

Question 2

Which Layer 2 protocol encapsulation type supports synchronous and asynchronous circuits and has built-in security mechanisms?

- A. X.25
- B. HDLC
- C. PPP
- D. Frame Relay

Answer: C

Question 3

Which statements about using leased lines for your WAN infrastructure are true?

- A. Leased lines provide inexpensive WAN access.
- B. Leased lines with sufficient bandwidth can avoid latency between endpoints.
- C. Leased lines require little installation and maintenance expertise.
- D. Leased lines provide highly flexible bandwidth scaling.
- E. Multiple leased lines can share a router interface.
- F. Leased lines support up to T1 link speeds.

Answer: B C

Question 4

Two routers named Atlanta and Brevard are connected by their serial interfaces as illustrated, but there is no connectivity between them. The Atlanta router is known to have a correct configuration. Given the partial configurations, identify the problem on the Brevard router that is causing the lack of connectivity.

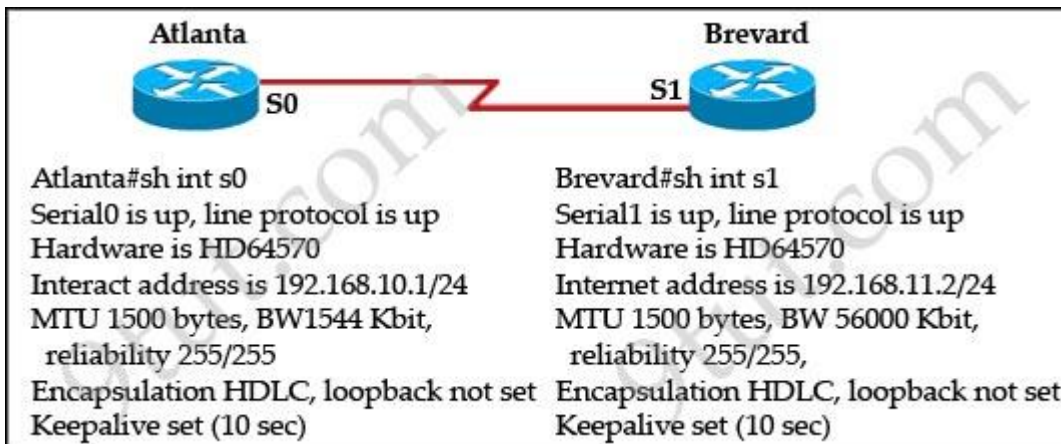

- A. transmission unit size too large
- B. no loopback set
- C. an incorrect subnet mask
- D. incompatible encapsulation at each end
- E. an incorrect IP address
- F. incompatible bandwidth between routers

Answer: E

Question 5

Which of the following describes the roles of devices in a WAN? (Choose three)

- A. A CSU/DSU terminates a digital local loop
- B. A modem terminates a digital local loop
- C. A CSU/DSU terminates an analog local loop
- D. A modem terminates an analog local loop
- E. A router is commonly considered a DTE device
- F. A router is commonly considered a DCE device

Answers: A D E

Question 6

Which two pieces of information are provided by the "show controllers serial 0" command? (Choose two)

- A. the type of cable that is connected to the interface.
- B. The uptime of the interface
- C. the status of the physical layer of the interface
- D. the full configuration of the interface
- E. the interface's duplex settings

Answer: A C

Question 7

Which command is used to know the duplex speed of serial link?

- A. show line
- B. show interface
- C. show protocol
- D. show run

Answer: B

Question 8

Which WAN topology provides a direct connection from each site to all other sites on the network?

- A. single-homed
- B. full mesh
- C. point-to-point
- D. hub-and-spoke

Answer: B

Question 9

What are three reasons that an organization with multiple branch offices and roaming users might implement a Cisco VPN solution instead of point-to-point WAN links? (Choose three)

- A. reduced cost
- B. better throughput
- C. broadband incompatibility
- D. increased security
- E. scalability
- F. reduced latency

Answer: A D E

Question 10

Which three statements about DWDM are true? (Choose three)

- A. It allows a single strand of fiber to support bidirectional communications
- B. It is used for long-distance and submarine cable systems
- C. It can multiplex up to 256 channels on a single fiber
- D. It supports both the SDH and SONET standards
- E. Each channel can carry up to a 1-Gbps signal
- F. It supports simplex communications over multiple strands of fiber

Answer: C D E

Question 11

Which PPP subprotocol negotiates authentication options?

- A. NCP
- B. ISDN
- C. SUP
- D. LCP
- E. DLCI

Answer: D

PPP Questions

<http://www.9tut.com/ppp-questions>

Question 1

Which two statements about using the CHAP authentication mechanism in a PPP link are true?
(Choose two)

- A. CHAP uses a two-way handshake.
- B. CHAP uses a three-way handshake.
- C. CHAP authentication periodically occurs after link establishment.
- D. CHAP authentication passwords are sent in plaintext.
- E. CHAP authentication is performed only upon link establishment.
- F. CHAP has no protection from playback attacks.

Answer: B C

Question 2

A network administrator needs to configure a serial link between the main office and a remote location. The router at the remote office is a non-Cisco router. How should the network administrator configure the serial interface of the main office router to make the connection?

A. Main(config)# interface serial 0/0
Main(config-if)# ip address 172.16.1.1 255.255.255.252
Main(config-if)# no shut

B. Main(config)# interface serial 0/0
Main(config-if)# ip address 172.16.1.1 255.255.255.252
Main(config-if)# encapsulation ppp
Main(config-if)# no shut

C. Main(config)# interface serial 0/0
Main(config-if)# ip address 172.16.1.1 255.255.255.252
Main(config-if)# encapsulation frame-relay
Main(config-if)# authentication chap
Main(config-if)# no shut

D. Main(config)# interface serial 0/0
Main(config-if)#ip address 172.16.1.1 255.255.255.252
Main(config-if)#encapsulation ietf
Main(config-if)# no shut

Answer: B

Question 3

Refer to the exhibit:

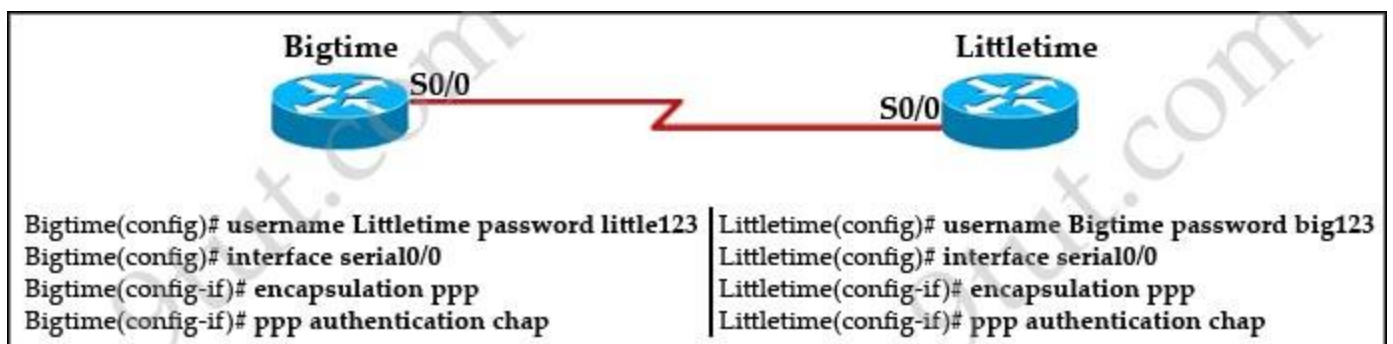

The Bigtime router is unable to authenticate to the Littletime router. What is the cause of the problem?

- A. The usernames are incorrectly configured on the two routers.
- B. The passwords do not match on the two routers.
- C. CHAP authentication cannot be used on a serial interface.
- D. The routers cannot be connected from interface S0/0 to interface S0/0.

E. With CHAP authentication, one router must authenticate to another router. The routers cannot be configured to authenticate to each other.

Answer: B

Question 4

What is the benefit of point-to-point leased line?

- A. Low cost
- B. Full-mesh capability
- C. Flexibility of design
- D. Simply configuration

Answer: D

Question 5

When you deploy multilink PPP on your network, where must you configure the group IP Address on each device?

- A. In the global config
- B. Under serial interface
- C. Under the routing protocol
- D. Under the multilink interface

Answer: D

Question 6

What are two authentication types of MLPPP?

- A. PEAP
- B. LEAP
- C. PAP
- D. CHAP
- E. TACACS+

Answer: C D

Question 7

At which layer of the OSI model does PPP perform?

- A. Layer 2
- B. Layer 3
- C. Layer 4
- D. Layer 5
- E. Layer 1

Answer: A

Question 8

Which command is used to enable CHAP authentication with PAP as the fallback method on a serial interface?

- A. (config-if)# authentication ppp chap fallback ppp
- B. (config-if)# authentication ppp chap pap
- C. (config-if)# ppp authentication chap pap
- D. (config-if)# ppp authentication chap fallback ppp

Answer: C

QoS Questions

<http://www.9tut.com/qos-questions>

Question 1

Which option describes the purpose of traffic policing?

- A. It prioritizes routing protocol traffic.
- B. It remarks traffic that is below the CIR.
- C. It drops traffic that exceeds the CIR.
- D. It queues and then transmits traffic that exceeds the CIR.

Answer: C

Question 2

Which statement about QoS default behavior is true?

- A. Ports are untrusted by default.
- B. VoIP traffic is passed without being tagged.

- C. Video traffic is passed with a well-known DSCP value of 46.
- D. Packets are classified internally with an environment.
- E. Packets that arrive with a tag are untagged at the edge of an administrative domain.

Answer: E

Question 3

What 8-bit field exists in IP packet for QoS?

- A. Tos Field
- B. DSCP
- C. IP Precedence
- D. Cos
- E. ?

Answer: A

Question 4

Which feature can you implement to reserve bandwidth for VoIP calls across the call path?

- A. round robin
- B. CBWFQ
- C. PQ
- D. RSVP

Answer: D

Question 5

What does traffic shaping do to reduce congestion in a network?

- A. buffers and queues packets
- B. buffers without queuing packets
- C. queues without buffering packets
- D. drops packets

Answer: A

Question 6

In which byte of an IP packet can traffic be marked?

- A. The CoS byte
- B. The ToS byte
- C. The DSCP byte
- D. The QoS byte

Answer: B

Question 7

Which function does traffic shaping perform?

- A. It buffers and queues excess packets
- B. It buffers traffic without queuing it
- C. It queues traffic without buffering it
- D. It drops packets to control the output rate

Answer: A

Question 8

Which option is the main function of congestion management?

- A. discarding excess traffic
- B. queuing traffic based on priority
- C. classifying traffic
- D. providing long-term storage of buffered data

Answer: B

Question 9

Which QoS tool can you use to optimize voice traffic on a network that is primarily intended for data traffic?

- A. WRED
- B. FIFO
- C. PQ
- D. WFQ

Answer: C

PPPoE Questions

<http://www.9tut.com/pppoe-questions>

Question 1

Which part of the PPPoE server configuration contains the information used to assign an IP address to a PPPoE client?

- A. virtual-template interface
- B. DHCP
- C. dialer interface
- D. AAA authentication

Answer: A

Question 2

During which phase of PPPoE is PPP authentication performed?

- A. the PPP Session phase
- B. Phase 2
- C. the Active Discovery phase
- D. the Authentication phase
- E. Phase 1

Answer: A

Question 3

Which type of interface can negotiate an IP address for a PPPoE client?

- A. Ethernet
- B. dialer
- C. serial
- D. Frame Relay

Answer: B

MPLS Questions

<http://www.9tut.com/mpls-questions>

Question 1

Which statement about MPLS is true?

- A. It operates in Layer 1.
- B. It operates between Layer 2 and Layer 3.
- C. It operates in Layer 3.
- D. It operates in Layer 2.

Answer: B

Question 2

Which two statements about MPLS are true? (Choose two)

- A. It provides automatic authentication
- B. It can carry multiple protocols, including IPv4 and IPv6
- C. It encapsulates all traffic in an IPv4 header
- D. It uses labels to separate and forward customer traffic
- E. It tags customer traffic using 802.1q

Answer: B D

DMVPN Questions

<http://www.9tut.com/dmvpn-questions>

Question 1

Which type of topology is required by DMVPN?

- A. ring
- B. full mesh
- C. hub-and-spoke
- D. partial mesh

Answer: C

Question 2

Which circumstances can cause a GRE tunnel to be in an up/down state? (Choose three)

- A. The tunnel interface IP address is misconfigured.
- B. The tunnel interface is down.
- C. A valid route to the destination address is missing from the routing table.
- D. The tunnel address is routed through the tunnel itself.
- E. The ISP is blocking the traffic.
- F. An ACL is blocking the outbound traffic.

Answer: B C D

Question 3

Which technology supports multiple dynamic secure connections on an unsecured transport network?

- A. DMVPN
- B. VPN
- C. Site-to-site VPN
- D. client VPN

Answer: A

CDP & LLDP Questions

<http://www.9tut.com/cdp-lldp-questions>

Question 1

Which command would you configure globally on a Cisco router that would allow you to view directly connected Cisco devices?

- A. cdp run
- B. enable cdp
- C. cdp enable
- D. run cdp

Answer: A

Question 2

Which statement about LLDP is true?

- A. It is a Cisco proprietary protocol.
- B. It is configured in global configuration mode.

- C. The LLDP update frequency is a fixed value.
- D. It runs over the transport layer.

Answer: B

Question 3

What is true about Cisco Discovery Protocol?

- A. it discovers the routers, switches and gateways.
- B. it is network layer protocol
- C. it is physical and data link layer protocol
- D. it is proprietary protocol

Answer: D

Question 4

Which command you enter on a switch to display the ip address associated with connected devices?

- A. show cdp neighbors detail
- B. show cdp neighbor
- C. show cdp interface
- D. show cdp traffic

Answer: A

Question 5

Which command would you configure globally on a Cisco router that to re-enable CDP if it was disabled by the administrator?

- A. enable cdp
- B. cdp enable
- C. cdp run
- D. run cdp

Answer: C

Question 6

Which statement about Cisco Discovery Protocol is true?

- A. It is Cisco-proprietary Protocol
- B. It can discover information from routers, firewalls and switches
- C. It runs on the network layer
- D. It runs on the physical layer and the data link layer.

Answer: A

Question 7

Which two pieces of information can be shared with LLDP TLVs? (Choose two)

- A. device management address
- B. device type
- C. spanning-tree topology
- D. routing configuration
- E. access-list configuration

Answer: A B

IP Address Questions

<http://www.9tut.com/ip-address-questions>

Question 1

Which two statements about IPv4 multicast traffic are true? (Choose two)

- A. It burdens the source host without affecting remote hosts.
- B. It uses a minimum amount of network bandwidth.
- C. It is bandwidth-intensive.
- D. It simultaneously delivers multiple streams of data.
- E. It is the most efficient way to deliver data to multiple receivers.

Answer: B E

Question 2

What are benefits of private IPv4 IP addresses?

- A. They are routed the same as public IP addresses.
- B. They are less costly than public IP addresses.
- C. They can be assigned to devices without Internet connections.

- D. They eliminate the necessity for NAT policies.
- E. They eliminate duplicate IP conflicts.

Answer: B C

Question 3

What will happen if a private IP address is assigned to a public interface connected to an ISP?

- A. A conflict of IP addresses happens, because other public routers can use the same range.
- B. Addresses in a private range will not be routed on the Internet backbone.
- C. Only the ISP router will have the capability to access the public network.
- D. The NAT process will be used to translate this address to a valid IP address.

Answer: B

Question 4

Which destination IP address can a host use to send one message to multiple devices across different subnets?

- A. 172.20.1.0
- B. 127.0.0.1
- C. 192.168.0.119
- D. 239.255.0.1

Answer: D

Question 5

Which RFC was created to alleviate the depletion of IPv4 public addresses?

- A. RFC 4193
- B. RFC 1519
- C. RFC 1518
- D. RFC 1918

Answer: C

Question 6

Which IPv6 feature is supported in IPv4 but is not commonly used?

- A. unicast
- B. multicast
- C. anycast
- D. broadcast

Answer: C

Question 7

What are two benefits of private IPv4 IP addresses? (Choose two)

- A. They are routed the same as public IP addresses.
- B. They are less costly than public IP addresses.
- C. They can be assigned to devices without Internet connections.
- D. They eliminate the necessity for NAT policies.
- E. They eliminate duplicate IP conflicts.

Answer: B C

Question 8

What are two benefits of private IPv4 addresses? (Choose two)

- A. they can be implemented without requiring admin to coordinate with IANA
- B. they are managed by IANA
- C. increase the flexibility of network design
- D. provide network isolation from the internet
- E. they are routable over internet

Answer: A D

Question 9

Which address class includes network 191.168.0.1/27?

- A. Class C
- B. Class B
- C. Class D
- D. Class A

Answer: B

Question 10

Which two options are the best reasons to use an IPV4 private IP space? (Choose two)

- A. to enable intra-enterprise communication
- B. to conserve global address space
- C. to manage routing overhead
- D. to connect applications
- E. to implement NAT

Answer: A B

Question 11

In which two circumstances are private IPv4 addresses appropriate? (Choose two)

- A. on internal hosts that stream data solely to external resources
- B. on hosts that communicates only with other internal hosts
- C. on the public-facing interface of a firewall
- D. on hosts that require minimal access to external resources
- E. to allow hosts inside an enterprise to communicate in both directions with hosts outside the enterprise

Answer: B D

Switch Questions

<http://www.9tut.com/switch-questions>

Question 1

Which switching method duplicates the first six bytes of a frame before making a switching decision?

- A. fragment-free switching
- B. cut-through switching
- C. store-and-forward switching
- D. ASIC switching

Answer: B

Question 2

Refer to the exhibit. Which of these statements correctly describes the state of the switch once the boot process has been completed?

```
00:00:39: %LINEPROTO-5-UPDOWN: Line protocol on Interface Vlan1, changed state to down
00:00:40: %SPANNTREE-5-EXTENDED_SYSID: Extended SysId enabled for type vlan
00:00:42: %SYS-5-CONFIG_I: Configured from memory by console
00:00:42: %SYS-5-RESTART: System restarted --
Cisco IOS Software, C2960 Software (C2960-LANBASEK9-M), Version 12.2(25)SEE2, RELEASE SOFTWARE (fc1
Copyright (c) 1986-2006 by Cisco Systems, Inc.
Compiled Fri 28-Jul-06 11:57 by yenanh
00:00:44: %LINK-5-CHANGED: Interface Vlan1, changed state to administratively down
00:00:44: %LINK-3-UPDOWN: Interface FastEthernet0/1, changed state to up
00:00:44: %LINK-3-UPDOWN: Interface FastEthernet0/2, changed state to up
00:00:44: %LINK-3-UPDOWN: Interface FastEthernet0/11, changed state to up
00:00:45: %LINEPROTO-5-UPDOWN: Line protocol on Interface FastEthernet0/1, changed state to up
00:00:45: %LINEPROTO-5-UPDOWN: Line protocol on Interface FastEthernet0/2, changed state to up
00:00:45: %LINEPROTO-5-UPDOWN: Line protocol on Interface FastEthernet0/11, changed state to up
00:00:48: %LINK-3-UPDOWN: Interface FastEthernet0/12, changed state to up
00:00:49: %LINEPROTO-5-UPDOWN: Line protocol on Interface FastEthernet0/12, changed state to up
```

- A. As FastEthernet0/12 will be the last to come up, it will not be blocked by STP.
- B. Remote access management of this switch will not be possible without configuration change.
- C. More VLANs will need to be created for this switch.
- D. The switch will need a different IOS code in order to support VLANs and STP.

Answer: B

Question 3

The network administrator normally establishes a Telnet session with the switch from host A. The administrator's attempt to establish a connect via Telnet to the switch from host B fails, but pings from host B to other two hosts are successful. What is the issue for this problem?

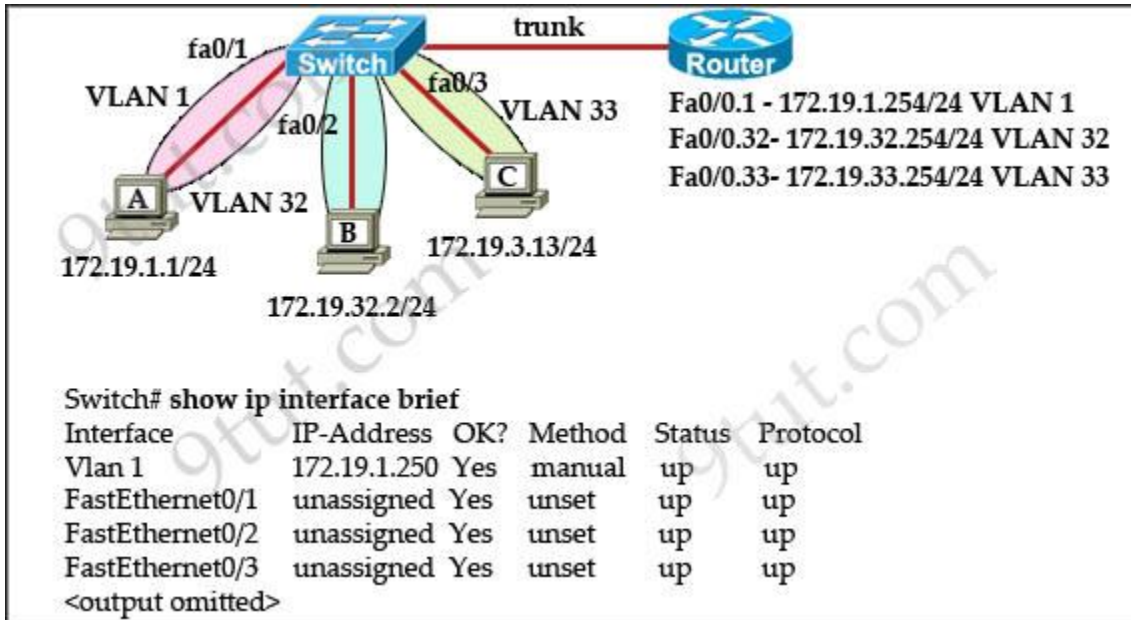

- A. Host B and the switch need to be in the same subnet.
- B. The switch needs an appropriate default gateway assigned.
- C. The switch interface connected to the router is down.
- D. Host B need to be assigned an IP address in vlan 1.

Answer: B

Question 4

The network administrator cannot connect to Switch1 over a Telnet session, although the hosts attached to Switch1 can ping the interface Fa0/0 of the router. Given the information in the graphic and assuming that the router and Switch2 are configured properly, which of the following commands should be issued on Switch1 to correct this problem?



- A. Switch1 (config)# line con0
Switch1 (config-line)# password cisco
Switch1 (config-line)#login
- B. Switch1 (config)# interface fa0/1
Switch 1(config-if)# ip address 192.168.24.3 255.255.255.0
- C. Switch1 (config)# ip default-gateway 192.168.24.1
- D. Switch1 (config)# interface fa0/1
Switch 1(config-if)# duplex full
Switch 1(config-if)# speed 100
- E. Switch1 (config)# interface fa0/1
Switch 1(config-if)# switchport mode trunk

Answer: C

Question 5

Which command can you use to set the hostname on a switch?

- A. switch-mdf-c1(config)#hostname switch-mdf1
- B. switch-mdf-c1>hostname switch-mdf1
- C. switch-mdf-c1#hostname switch-mdf1
- D. switch-mdf-c1(config-if)#hostname switch-mdf1

Answer: A

Question 6

Refer to the exhibit. What is the effect of the given configuration?

```
Switch#configuration terminal
Switch#interface VLAN 1
Switch(config-if)#ip address 192.168.2.2 255.255.255.0
Switch(config-if)#end
```

- A. It configures an inactive switch virtual interface.
- B. It configures an active management interface.
- C. It configures the native VLAN.
- D. It configures the default VLAN.

Answer: A

Question 7

Which statement about switch access ports is true?

- A. They drop packets with 802.1Q tags.
- B. A VLAN must be assigned to an access port before it is created.
- C. They can receive traffic from more than one VLAN with no voice support
- D. By default, they carry traffic for VLAN 10.

Answer: A

Question 8

Which feature allows a device to use a switch port that is configured for half-duplex to access the network?

- A. CSMA/CD
- B. IGMP
- C. port security
- D. split horizon

Answer: A

Question 9

Which option is a invalid hostname for a switch?

- A. 5switch-Cisco
- B. Switch-Cisco!
- C. 5switchCisc0
- D. SwitchCisc0

Answer: B

Question 10

Which statement about unicast frame forwarding on a switch is true?

- A. The TCAM table stores destination MAC addresses
- B. If the destination MAC address is unknown, the frame is flooded to every port that is configured in the same VLAN except on the port that it was received on.
- C. The CAM table is used to determine whether traffic is permitted or denied on a switch
- D. The source address is used to determine the switch port to which a frame is forwarded

Answer: B

Question 11

Two hosts are attached to a switch with the default configuration. Which statement about the configuration is true?

- A. IP routing must be enabled to allow the two hosts to communicate.
- B. The two hosts are in the same broadcast domain.
- C. The switch must be configured with a VLAN to allow the two hosts to communicate.
- D. Port security prevents the hosts from connecting to the switch.

Answer: B

Switch Questions 2

<http://www.9tut.com/switch-questions-2>

Question 1

Configuration of which option is required on a Cisco switch for the Cisco IP phone to work?

- A. PortFast on the interface
- B. the interface as an access port to allow the voice VLAN ID

- C. a voice VLAN ID in interface and global configuration mode
- D. Cisco Discovery Protocol in global configuration mode

Answer: B

Question 2

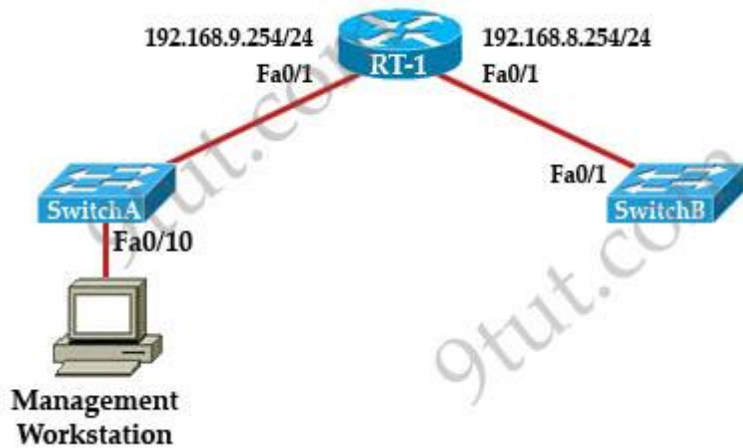

A technician has installed SwitchB and needs to configure it for remote access from the management workstation connected SwitchA. Which set of commands is required to accomplish this task?

- A.
SwitchB(config)#interface FastEthernet 0/1
SwitchB(config-if)#ip address 192.168.8.252 255.255.255.0
SwitchB(config-if)#no shutdown
- B.
SwitchB(config)#ip default-gateway 192.168.8.254
SwitchB(config)#interface vlan 1
SwitchB(config-if)#ip address 192.168.8.252 255.255.255.0
SwitchB(config-if)#no shutdown
- C.
SwitchB(config)#interface vlan 1
SwitchB(config-if)#ip address 192.168.8.252 255.255.255.0
SwitchB(config-if)#ip default-gateway 192.168.8.254 255.255.255.0
SwitchB(config-if)#no shutdown
- D.
SwitchB(config)#ip default-network 192.168.8.254
SwitchB(config)#interface vlan 1
SwitchB(config-if)#ip address 192.168.8.252 255.255.255.0
SwitchB(config-if)#no shutdown

Answer: B

Question 3

Which three statements accurately describe layer 2 Ethernet switches? (choose three)

- A. Microsegmentation decreases the number of collisions on the network.
- B. If a switch receives a frame for an unknown destination, it uses ARP to resolve the address.
- C. Spanning Tree Protocol allows switches to automatically share vlan information.
- D. In a properly functioning network with redundant switched paths, each switched segment will contain one root bridge with all its ports in the forwarding state. All other switches in that broadcast domain will have only one root port.
- E. Establishing vlans increases the number of broadcast domains.
- F. Switches that are configured with vlans make forwarding decisions based on both layer 2 and layer 3 address information.

Answer: A D E

Question 4

Refer to the exhibit. Give this output for SwitchC, what should the network administrator's next action be?

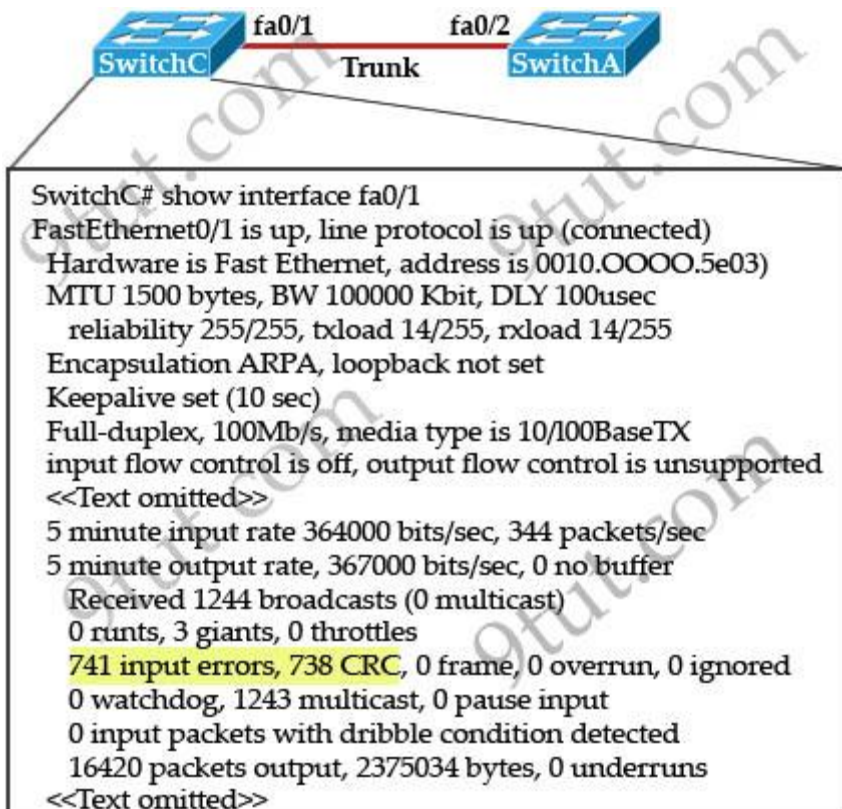

- A. Check the trunk encapsulation mode for SwitchC's fa0/1 port.
- B. Check the duplex mode for SwitchC's fa0/1 port.

- C. Check the duplex mode for SwitchA's fa0/2 port.
- D. Check the trunk encapsulation mode for SwitchA's fa0/2 port.

Answer: C

Question 5

Refer to the exhibit.

```
Switch-1# show mac address-table
Dynamic Addresses Count:          3
Secure Addresses (User-defined) Count: 0
Static Addresses (User-defined) Count: 0
System Self Addresses Count:     41
Total Mac addresses:             50
Non-static Address Table:
Destination Address  Address Type  VLAN  Destination Port
-----
0010.0de0.e289      Dynamic      1     FastEthernet0/1
0010.7b00.1540      Dynamic      2     FastEthernet0/3
0010.7b00.1545      Dynamic      2     FastEthernet0/2
```

Switch-1 needs to send data to a host with a MAC address of 00b0.d056.efa4. What will Switch-1 do with this data?

- A. Switch-1 will drop the data because it does not have an entry for that MAC address.
- B. Switch-1 will forward the data to its default gateway.
- C. Switch-1 will flood the data out all of its ports except the port from which the data originated.
- D. Switch-1 will send an ARP request out all its ports except the port from which the data originated.

Answer: C

Question 6

Which utility can you use to determine whether a switch can send echo requests and replies?

- A. ping
- B. traceroute
- C. ssh
- D. telnet

Answer: A

Question 7

On which type of port can switches interconnect for multi-VLAN communication?

- A. interface port
- B. access port
- C. switch port
- D. trunk port

Answer: D

Question 8

Which two types of information are held in the MAC address table? (Choose two)

- A. MAC address
- B. source IP address
- C. destination IP address
- D. Protocols
- E. Port numbers

Answer: A E

Question 9

What type of MAC address is aged automatically by the switch?

- A. Dynamic
- B. Static
- C. Auto

Answer: A

Question 10

Which of the three options are switchbox configurations that can always avoid duplex mismatch errors between two switches? (Choose three)

- A. Set one side of the connection to the full duplex and the other side to half duplex
- B. Set both sides of the connection to full duplex
- C. Set one side of the connection to auto-negotiate and the other side to half duplex
- D. Set one side of the connection to auto-negotiate and the other side to full duplex
- E. Set both sides of the connection to auto-negotiate
- F. Set both sides of the connection to half duplex

Answer: B E F

Question 11

Refer to the exhibit.

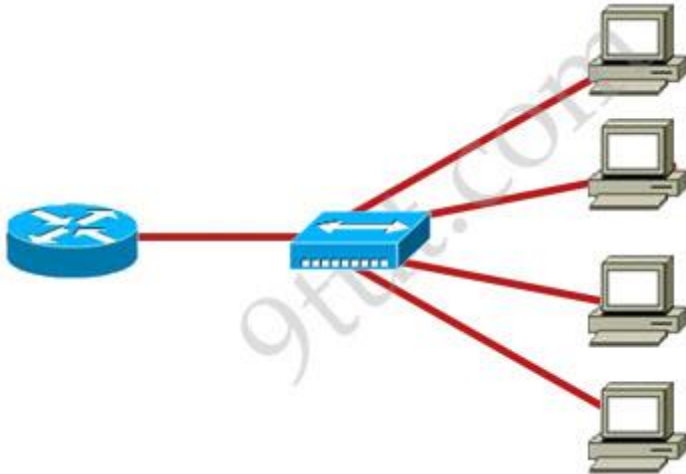

What two results would occur if the hub were to be replaced with a switch that is configured with one Ethernet VLAN? (Choose two)

Note: This question may or may not have the exhibit.

- A. The number of collision domains would remain the same.
- B. The number of collision domains would decrease.
- C. The number of collision domains would increase.
- D. The number of broadcast domains would remain the same.
- E. The number of broadcast domains would decrease.
- F. The number of broadcast domains would increase.

Answer: C D

VLAN Questions

<http://www.9tut.com/vlan-questions>

Question 1

What are three benefits of implementing VLANs? (Choose three)

- A. A more efficient use of bandwidth can be achieved allowing many physical groups to use the same network infrastructure.
- B. A higher level of network security can be reached by separating sensitive data traffic from other

network traffic.

C. Broadcast storms can be mitigated by increasing the number of broadcast domains, thus reducing their size.

D. A more efficient use of bandwidth can be achieved allowing many logical networks to use the same network infrastructure.

E. Port-based VLANs increase switch-port use efficiency, thanks to 802.1 Q trunks.

F. VLANs make it easier for IT staff to configure new logical groups, because the VLANs all belong to the same broadcast domain. Broadcast storms can be mitigated by decreasing the number of broadcast domains, thus increasing their size.

Answer: B C D

Question 2

Which command can you enter to view the ports that are assigned to VLAN 20?

A. Switch#show ip interface brief

B. Switch#show interface vlan 20

C. Switch#show ip interface vlan 20

D. Switch#show vlan id 20

Answer: D

Question 3

What are three advantages of VLANs? (Choose three)

A. They allow access to network services based on department, not physical location.

B. They provide a method of conserving IP addresses in large networks.

C. They utilize packet filtering to enhance network security.

D. They can simplify adding, moving, or changing hosts on the network.

E. They provide a low-latency internetworking alternative to routed networks.

F. They establish broadcast domains in switched networks.

Answer: A D F

Question 4

Which command sequence can you enter to create VLAN 20 and assign it to an interface on a switch?

A. Switch(config)#vlan 20

Switch(config)#interface gig x/y

Switch(config-if)#switchport access vlan 20

B. Switch(config)#interface gig x/y
Switch(config-if)#vlan 20
Switch(config-vlan)#switchport access vlan 20

C. Switch(config)#vlan 20
Switch(config)#interface vlan 20
Switch(config-if)#switchport trunk native vlan 20

D. Switch(config)#vlan 20
Switch(config)#interface vlan 20
Switch(config-if)#switchport access vlan 20

E. Switch(config)#vlan 20
Switch(config)#interface vlan 20
Switch(config-if)#switchport trunk allowed vlan 20

Answer: A

Question 5

Which two circumstances can cause collision domain issues on VLAN domain? (Choose two)

- A. duplex mismatches on Ethernet segments in the same VLAN
- B. multiple errors on switchport interfaces
- C. congestion on the switch inband path
- D. a failing NIC in an end device
- E. an overloaded shared segment

Answer: A C

Question 6

What is the default VLAN on an access port?

- A. 0
- B. 1
- C. 10
- D. 1024

Answer: B

Question 7

Which statement about native VLAN traffic is true?

- A. Cisco Discovery Protocol traffic travels on the native VLAN by default
- B. Traffic on the native VLAN is tagged with 1 by default
- C. Control plane traffic is blocked on the native VLAN.
- D. The native VLAN is typically disabled for security reasons

Answer: A

Question 8

Refer to the exhibit. Which statement describes the effect of this configuration?

```
Router#configure terminal
Router(config)#vlan 10
Router(config-vlan)#do show vlan
```

- A. The VLAN 10 VTP configuration is displayed.
- B. VLAN 10 spanning-tree output is displayed.
- C. The VLAN 10 configuration is saved when the router exits VLAN configuration mode.
- D. VLAN 10 is added to the VLAN database.

Answer: C

Question 9

Which method does a connected trunk port use to tag VLAN traffic?

- A. IEEE 802.1w
- B. IEEE 802.1D
- C. IEEE 802.1Q
- D. IEEE 802.1p

Answer: C

Question 10

Which of the following are benefits of VLANs? (Choose three)

- A. They increase the size of collision domains.
- B. They allow logical grouping of users by function.
- C. They can enhance network security.
- D. They increase the size of broadcast domains while decreasing the number of collision domains.
- E. They increase the number of broadcast domains while decreasing the size of the broadcast domains.
- F. They simplify switch administration.

Answer: B C E

VLAN Questions 2

<http://www.9tut.com/vlan-questions-2>

Question 1

Which feature facilitate the tagging of a specific VLAN?

- A. Routing
- B. Hairpinning
- C. Encapsulation
- D. Switching

Answer: C

Question 2

What are three advantages of VLANs? (Choose three)

- A. VLANs establish broadcast domains in switched networks.
- B. VLANs utilize packet filtering to enhance network security.
- C. VLANs provide a method of conserving IP addresses in large networks.
- D. VLANs provide a low-latency internetworking alternative to routed networks.
- E. VLANs allow access to network services based on department, not physical location.
- F. VLANs can greatly simplify adding, moving, or changing hosts on the network.

Answer: A E F

Question 3

Under normal operations, Cisco recommends that you configure switch ports on which VLAN?

- A. on the default vlan
- B. on the management vlan
- C. on the native vlan
- D. on any vlan except the default vlan

Answer: D

Question 4

Which two protocols can detect native VLAN mismatch errors? (Choose two)

- A. CDP
- B. VTP
- C. DTP
- D. STP
- E. PAGP

Answer: A D

Question 5

Which statement about VLAN configuration is true?

- A. The switch must be in VTP server or transparent mode before you can configure a VLAN
- B. The switch must be in config-vlan mode before you configure an extended VLAN
- C. Dynamic inter-VLAN routing is supported on VLAN2 through VLAN 4064
- D. A switch in VTP transparent mode saves the VLAN databases to the running configuration only

Answer: A

Question 6

Which statement about VLAN operation on Cisco Catalyst switches is true?

- A. When a packet is received from an 802.1Q trunk, the VLAN ID can be determined from the source MAC address table.
- B. Unknown unicast frames are retransmitted only to the ports that belong to the same VLAN.
- C. Ports between switches should be configured in access mode so that VLANs can span across the ports.
- D. Broadcast and multicast frames are retransmitted to ports that are configured on different VLANs.

Answer: B

Question 7

Which two statements about data VLANs on access ports are true? (Choose two)

- A. They can be configured as trunk ports
- B. Two or more VLANs can be configured on the interface
- C. 802.1Q encapsulation must be configured on the interface

- D. Exactly one VLAN can be configured on the interface.
- E. They can be configured as host ports.

Answer: D E

Question 8

Which feature facilitates the tagging of frames on a specific VLAN?

- A. Routing
- B. Hairpinning
- C. Switching
- D. Encapsulation

Answer: D

Question 9

Assuming the default switch configuration which vlan range can be added modified and removed on a Cisco switch?

- A. 2 through 1001
- B. 1 through 1001
- C. 1 through 1002
- D. 2 through 1005

Answer: A

Trunking Questions

<http://www.9tut.com/trunking-questions>

Question 1

Which command can you enter to determine whether a switch is operating in trunking mode?

- A. show vlan
- B. show ip interface brief
- C. show interfaces
- D. show interface switchport

Answer: D

Question 2

Which two commands can be used to verify a trunk link configuration status on a Cisco switch?
(choose two)

- A. show interfaces trunk
- B. show interfaces switchport
- C. show ip interface brief
- D. show interfaces vlan

Answer: A B

Question 3

Refer to the exhibit:

```
ALSwitch1# show interfaces fastethernet0/24 switchport
Name: Fa0/24
Switchport: Enabled
Administrative Mode: static access
Operational Mode: static access
Administrative Trunking Encapsulation: dot1q
Operational Trunking Encapsulation: native
Negotiation of Trunking: Off
Access Mode VLAN1 (default)
Trunking Native Mode VLAN: 1 (default)
Voice VLAN: none
Administrative private-vlan host-association: none
Administrative private-vlan mapping: none
Operational private-vlan: none
Trunking VLANs Enabled: ALL
Pruning VLANs Enabled: 2-1001
Capture Mode Disabled
Capture VLANs Allowed: ALL

Protected: false

Voice VLAN: none (Inactive)
Appliance trust: none
```

Switch port FastEthernet 0/24 on ALSwitch1 will be used to create an IEEE 802.1Q-complaint trunk to another switch. Based on the output shown, What is the reason the trunk does not form, even though the proper cabling has been attached?

- A. VLANs have not been created yet.
- B. An IP address must be configured for the port.
- C. The port is currently configured for access mode.
- D. The correct encapsulation type has not been configured.
- E. The no shutdown command has not been entered for the port.

Answer: C

Question 4

Which two of these are characteristics of the 802.1Q protocol? (Choose two)

- A. It is a layer 2 messaging protocol which maintains vlan configurations across network.
- B. It includes an 8-bit field which specifies the priority of a frame.
- C. It is used exclusively for tagging vlan frames and does not address network reconvergence following switched network topology changes.
- D. It modifies the 802.3 frame header and thus requires that the FCS be recomputed.
- E. It is a trunking protocol capable of carrying untagged frames.

Answer: D E

Question 5

How to create a trunk port and allow VLAN 20? (Choose three)

- A. switchport trunk encapsulation dot1q
- B. switchport mode trunk
- C. switchport trunk allowed vlan 20
- D. switchport trunk native vlan 20
- E. ?

Answer: A B C

Question 6

Which mode is compatible with Trunk, Access, and desirable ports?

- A. Trunk Ports
- B. Access Ports
- C. Dynamic Auto
- D. Dynamic Desirable

Answer: C (?)

Question 7

What field is consist of 6 bytes in the field identification frame in IEEE 802.1Q?

- A. SA
- B. DA
- C. FCS
- D. other

Answer: A

Question 8

Which statement about DTP is true?

- A. It uses the native VLAN.
- B. It negotiates a trunk link after VTP has been configured.
- C. It uses desirable mode by default.
- D. It sends data on VLAN 1.

Answer: D

Question 9

How can you disable DTP on a switch port?

- A. Configure the switch port as a trunk.
- B. Add an interface on the switch to a channel group.
- C. Change the operational mode to static access.
- D. Change the administrative mode to access.

Answer: A (no correct answer, in fact)

Question 10

What is true about DTP? (Choose three)

- A. Layer 2 protocol
- B. Layer 3 protocol
- C. Proprietary protocol
- D. enabled by default
- E. disabled by default

Answer: A C D

Trunking Questions 2

<http://www.9tut.com/trunking-questions-2>

Question 1

Which DTP switchport mode allow the port to create a trunk port if the the port is in trunk, dynamic auto and dynamic desirable mode?

- A. Dynamic Auto
- B. Dynamic Desirable
- C. Access
- D. Trunk

Answer: B

Question 2

What is the function of the command **switchport trunk native vlan 999** on a trunk port?

- A. It designates VLAN 999 for untagged traffic.
- B. It blocks VLAN 999 traffic from passing on the trunk.
- C. It creates a VLAN 999 interface.
- D. It designates VLAN 999 as the default for all unknown tagged traffic.

Answer: A

Question 3

Refer to the exhibit:

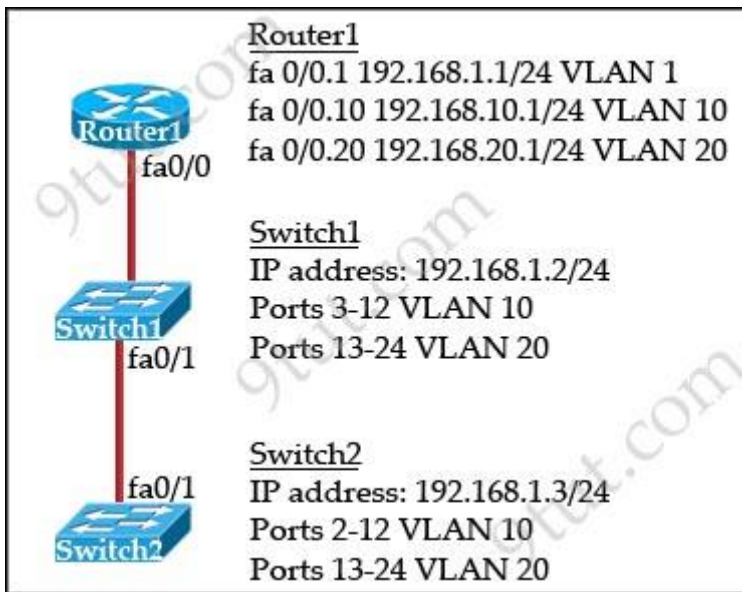

How should the FastEthernet0/1 port on the 2950 model switches that are shown in the exhibit be configured to allow connectivity between all devices?

A. The ports only need to be connected by a crossover cable.

B. SwitchX (config)#interface FastEthernet 0/1
 SwitchX(config-if)#switchport mode trunk

C. SwitchX (config)#interface FastEthernet 0/1
 SwitchX(config-if)#switchport mode access
 SwitchX(config-if)#switchport access vlan 1

D. SwitchX (config)#interface FastEthernet 0/1
 SwitchX(config-if)#switchport mode trunk
 SwitchX(config-if)#switchport trunk vlan 1
 SwitchX(config-if)#switchport trunk vlan 10
 SwitchX(config-if)#switchport trunk vlan 20

Answer: B

Question 4

Refer to the exhibit:

```
Switch1# show mac address-table
```

```
System Self Addresses Count: 41
```

```
Total MAC addresses: 50
```

```
Non-static Address Table:
```

Destination Address	AddressType	VLAN	Destination Port
00A0.0de0.e289	Dynamic	1	FastEthernet0/1
00A0.7b00.1540	Dynamic	2	FastEthernet0/5
00A0.7b00.1545	Dynamic	2	FastEthernet0/5
00A0.5c74.0076	Dynamic	1	FastEthernet0/1
00A0.5cf4.0077	Dynamic	3	FastEthernet0/1
00A0.5cf4.1315	Dynamic	1	FastEthernet0/1
00A0.70cb.f301	Dynamic	2	FastEthernet0/1
00A0.70cb.3f01	Dynamic	5	FastEthernet0/2
00A0.1e42.9978	Dynamic	4	FastEthernet0/1
00A0.1e9f.3900	Dynamic	3	FastEthernet0/1
00A0.70cb.33f1	Dynamic	6	FastEthernet0/3
00A0.70cb.103f	Dynamic	6	FastEthernet0/4

```
<output omitted>
```

```
Switch1# show cdp neighbors
```

```
Capability Codes: R - Router, T - Trans Bridge, B - Source Route Bridge  
S - Switch, H - Host, I - IGMP, r - Repeater
```

Device ID	Local Intrfce	Holdtime	Capability	Platform	Port ID
Switch2	Fas 0/1	157	S	2950-12	Fas 0/1
Switch3	Fas 0/2	143	S	2950-12	Fas 0/5

```
Switch1#
```

Which two statements are true of the interfaces on Switch1? (Choose two)

- A. Interface FastEthernet0/2 has been disabled.
- B. Multiple devices are connected directly to FastEthernet0/1.
- C. FastEthernet0/1 is configured as a trunk link.
- D. FastEthernet0/1 is connected to a host with multiple network interface cards
- E. FastEthernet0/5 has statically assigned MAC addresses.
- F. A hub is connected directly to FastEthernet0/5

Answer: C F

Question 5

Which IEEE standard protocol is initiated as a result of successful DTP completion in a switch over FastEthernet?

- A. 802.3ad
- B. 802.1w
- C. 802.1Q
- D. 802.1d

Answer: C

Question 6

Which three of these statements regarding 802.1Q trunking are correct? (Choose three)

- A. 802.1Q native VLAN frames are untagged by default.
- B. 802.1Q trunking ports can also be secure ports.
- C. 802.1Q trunks can use 10 Mb/s Ethernet interfaces.
- D. 802.1Q trunks require full-duplex, point-to-point connectivity.
- E. 802.1Q trunks should have native VLANs that are the same at both ends.

Answer: A C E

Question 7

What are the possible trunking modes for a switch port? (Choose three)

- A. transparent
- B. auto
- C. on
- D. desirable
- E. client
- F. forwarding

Answer: B C D

STP Questions

<http://www.9tut.com/stp-questions>

Question 1

Refer to the topology shown in the exhibit. Which ports will be STP designated ports if all the links are operating at the same bandwidth? (Choose three)

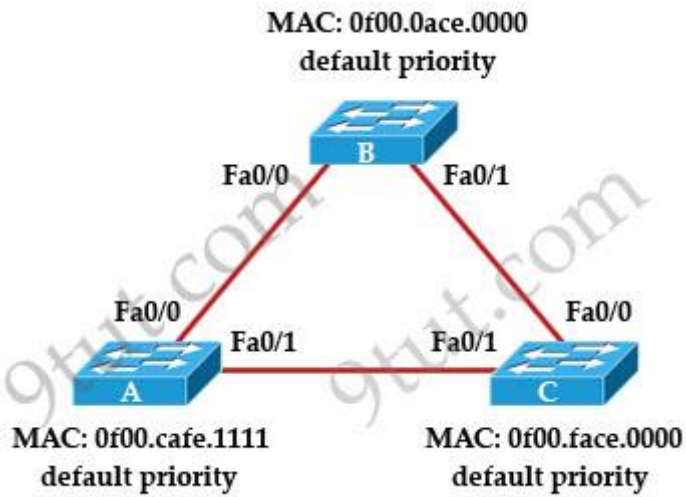

- A. Switch A – Fa0/0
- B. Switch A – Fa0/1
- C. Switch B – Fa0/0
- D. Switch B – Fa0/1
- E. Switch C – Fa0/0
- F. Switch C – Fa0/1

Answer: B C D

Question 2

If the primary root bridge experiences a power loss, which switch takes over?

- A. switch 0040.0BC0.90C5
- B. switch 00E0.F90B.6BE3
- C. switch 0004.9A1A.C182
- D. switch 00E0.F726.3DC6

Answer: C

Question 3

Refer to the topology shown in the exhibit. Which ports will be STP designated ports if all the links are operating at the same bandwidth? (Choose three)

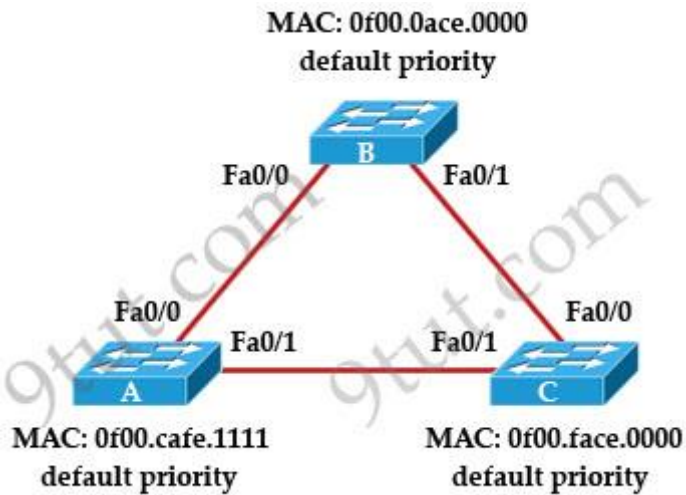

- A. Switch A – Fa0/0
- B. Switch A – Fa0/1
- C. Switch B – Fa0/0
- D. Switch B – Fa0/1
- E. Switch C – Fa0/0
- F. Switch C – Fa0/1

Answer: B C D

Question 4

If primary and secondary root switches with priority 16384 both experience catastrophic losses, which tertiary switch can take over?

- A. a switch with priority 20480
- B. a switch with priority 8192
- C. a switch with priority 4096
- D. a switch with priority 12288

Answer: A

Question 5

Which spanning-tree protocol rides on top of another spanning-tree protocol?

- A. MSTP
- B. RSTP
- C. PVST+
- D. Mono Spanning Tree

Answer: A

Question 6

Which IEEE standard does PVST+ use to tunnel information?

- A. 802.1x
- B. 802.1q
- C. 802.1w
- D. 802.1s

Answer: B

Question 7

Which process is associated with spanning-tree convergence?

- A. determining the path cost
- B. electing designated ports
- C. learning the sender bridge ID
- D. assigning the port ID

Answer: B

Question 8

Refer to the exhibit. The output that is shown is generated at a switch. Which three of these statements are true? (Choose three)

```
Switch# show spanning-tree vlan 30
VLAN0030
Spanning tree enabled protocol rstp
Root ID Priority 24606
Address 00d0.047b.2800
This bridge is the root
Hello Time 2 sec Max Age 20 sec Forward Delay 15 sec
Bridge ID Priority 24606 (priority 24576 sys-id-ext 30)
Address 00d0.047b.2800
Hello Time 2 sec Max Age 20 sec Forward Delay 15 sec
Aging Time 300
Interface    Role  Sts   Cost  Prio.Nbr  Type
-----
Fa1/1        Desg FWD   4     128.1   p2p
Fa1/2        Desg FWD   4     128.2   p2p
Fa5/1        Desg FWD   4     128.257 p2p
```

- A. All ports will be in a state of discarding, learning or forwarding.
- B. Thirty VLANs have been configured on this switch.
- C. The bridge priority is lower than the default value for spanning tree.
- D. All interfaces that are shown are on shared media.
- E. All designated ports are in a forwarding state.
- F. The switch must be the root bridge for all VLANs on this switch.

Answer: A C E

Question 9

Refer to the topology shown in the exhibit. Which ports will be STP designated ports if all the links are operating at the same bandwidth? (Choose three)

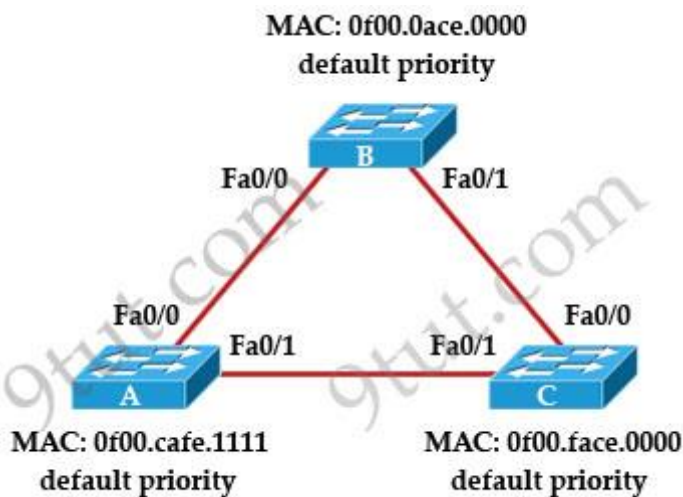

- A. Switch A – Fa0/0
- B. Switch A – Fa0/1
- C. Switch B – Fa0/0
- D. Switch B – Fa0/1
- E. Switch C – Fa0/0
- F. Switch C – Fa0/1

Answer: B C D

Question 10

When an interface is configured with PortFast BPDU guard, how does the interface respond when it receives a BPDU?

- A. It continues operating normally.
- B. It goes into an errdisable state.

- C. It goes into a down/down state.
- D. It becomes the root bridge for the configured VLAN.

Answer: B

STP Questions 2

<http://www.9tut.com/stp-questions-2>

Question 1

Which spanning-tree feature places a port immediately into a forwarding state?

- A. BPDU guard
- B. PortFast
- C. loop guard
- D. UDLD
- E. Uplink Fast

Answer: B

Question 2

Which switch would STP choose to become the root bridge in the selection process?

- A. 32768: 11-22-33-44-55-66
- B. 32768: 22-33-44-55-66-77
- C. 32769: 11-22-33-44-55-65
- D. 32769: 22-33-44-55-66-78

Answer: A

Question 3

Which type does a port become when it receives the best BPDU on a bridge?

- A. The designated port
- B. The backup port
- C. The alternate port
- D. The root port

Answer: D

Question 4

Which value can you modify to configure a specific interface as the preferred forwarding interface?

- A. The interface number
- B. The port priority
- C. The VLAN priority
- D. The hello time

Answer: B

Question 5

What is one benefit of PVST+?

- A. PVST+ reduces the CPU cycles for all the switches in the network.
- B. PVST+ automatically selects the root bridge location, to provide optimization.
- C. PVST+ allows the root switch location to be optimized per vlan.
- D. PVST+ supports Layer 3 load balancing without loops.

Answer: C

Question 6

Three switches are connected to one another via trunk ports. Assuming the default switch configuration, which switch is elected as the root bridge for the spanning-tree instance of VLAN 1?

- A. the switch with the highest MAC address
- B. the switch with the lowest MAC address
- C. the switch with the highest IP address
- D. the switch with the lowest IP address

Answer: B

Question 7

Which protocol is a Cisco proprietary implementation of STP?

- A. CST
- B. RSTP
- C. MSTP
- D. PVST+

Answer: D

Question 8

A BPDU guard is configured on an interface that has PortFast enable. Which state does the interface enter when it receives a BPDU?

- A. Blocking
- B. Shutdown
- C. Listening
- D. Errdisable

Answer: D

Question 9

Which two protocols are used by bridges and/or switches to prevent loops in a layer 2 network?
(Choose two)

- A. 802.1D
- B. VTP
- C. 802.1Q
- D. SAP
- E. STP

Answer: A E

Question 10

Refer to the exhibit. Which switch provides the spanning-tree designated port role for the network segment that services the printers?

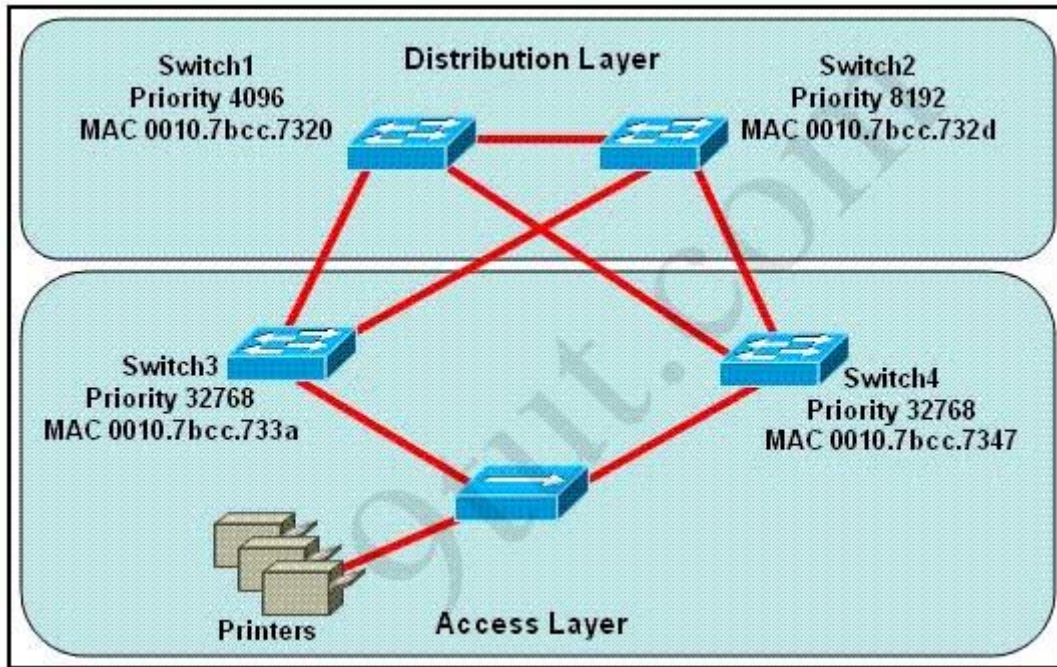

- A. Switch1
- B. Switch2
- C. Switch3
- D. Switch4

Answer: C

STP Questions 3

<http://www.9tut.com/stp-questions-3>

Question 1

When you enable PortFast on a switch port, the port immediately transitions to which state?

- A. Blocking
- B. Forwarding
- C. Learning
- D. Listening

Answer: B

Question 2

What can you change to select switch as root bridge?

- A. make lower priority
- B. make higher priority
- C. make lower path cost
- D. make higher path cost

Answer: A

Question 3

Which type of port role does not participate in STP calculation?

- A. Listening
- B. Learning
- C. Forwarding
- D. Discarding

Answer: D

Question 4

Which statement about spanning-tree root-bridge election is true?

- A. It is always performed automatically
- B. Each VLAN must have its own root bridge
- C. Each VLAN must use the same root bridge
- D. Each root bridge must reside on the same root switch

Answer: B

Question 5

A question about BPDU. What would a PortFast BPDU guard port do when it is configured on a port? (Choose two)

- A. err-disabled when port receives BPDUs
- B. supported only on nontrunking access ports
- C. forward when port receives BPDUs
- D. supported on trunk ports

Answer: A B

Question 6

What is one benefit of PVST+?

- A. PVST+reduces the CPU cycles for all the switches in the network
- B. PVST+automatically selects the root bridge location,to provide optimized bandwidth usage.
- C. PVST+allow the root switch location to be optimized per vlan.
- D. PVST+supports Layer 3 load balancing without loops.

Answer: C

Question 7

For which two protocols can PortFast alleviate potential host startup issues? (Choose two)

- A. DHCP
- B. DNS
- C. OSPF
- D. RIP
- E. CDP

Answer: A B

RSTP Questions

<http://www.9tut.com/rstp-questions>

Question 1

Which two spanning-tree port states does RSTP combine to allow faster convergence? (Choose two)

- A. discarding
- B. listening
- C. blocking
- D. forwarding
- E. learning

Answer: B C

Question 2

Refer to the exhibit. Each of these four switches has been configured with a hostname, as well as being configured to run RSTP. No other configuration changes have been made. Which three of these show the correct RSTP port roles for the indicated switches and interfaces? (Choose three)

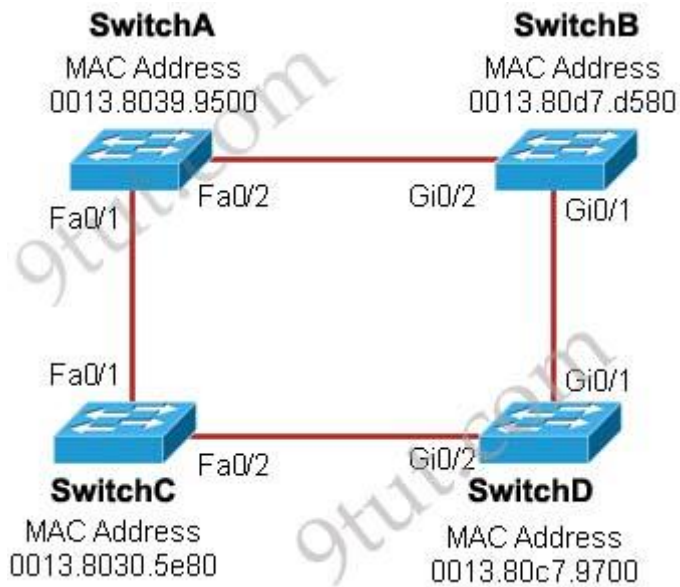

- A. SwitchA, Fa0/2, designated
- B. SwitchA, Fa0/1, root
- C. SwitchB, Gi0/2, root
- D. SwitchB, Gi0/1, designated
- E. SwitchC, Fa0/2, root
- F. SwitchD, Gi0/2, root

Answer: A B F

Question 3

Which two switch states are valid for 802.1w? (Choose two)

- A. listening
- B. backup
- C. disabled
- D. learning
- E. discarding

Answer: D E

Question 4

Which two states are the port states when RSTP has converged? (choose two)

- A. discarding
- B. learning
- C. disabled

- D. forwarding
- E. listening

Answer: A D

Question 5

Which three statements about RSTP are true? (choose three)

- A. RSTP significantly reduces topology reconverging time after a link failure.
- B. RSTP expands the STP port roles by adding the alternate and backup roles.
- C. RSTP port states are blocking, discarding, learning, or forwarding.
- D. RSTP also uses the STP proposal-agreement sequence.
- E. RSTP use the same timer-based process as STP on point-to-point links.
- F. RSTP provides a faster transition to the forwarding state on point-to-point links than STP does.

Answer: A B F

Question 6

Which command enables RSTP on a switch?

- A. spanning-tree mode rapid-pvst
- B. spanning-tree uplinkfast
- C. spanning-tree backbonefast
- D. spanning-tree mode mst

Answer: A

Question 7

Which two of these statements regarding RSTP are correct? (Choose two)

- A. RSTP cannot operate with PVST+.
- B. RSTP defines new port roles.
- C. RSTP defines no new port states.
- D. RSTP is a proprietary implementation of IEEE 802.1D STP.
- E. RSTP is compatible with the original IEEE 802.1D STP.

Answer: B E

Question 8

Refer to the exhibit. At the end of an RSTP election process, which access layer switch port will assume the discarding role?

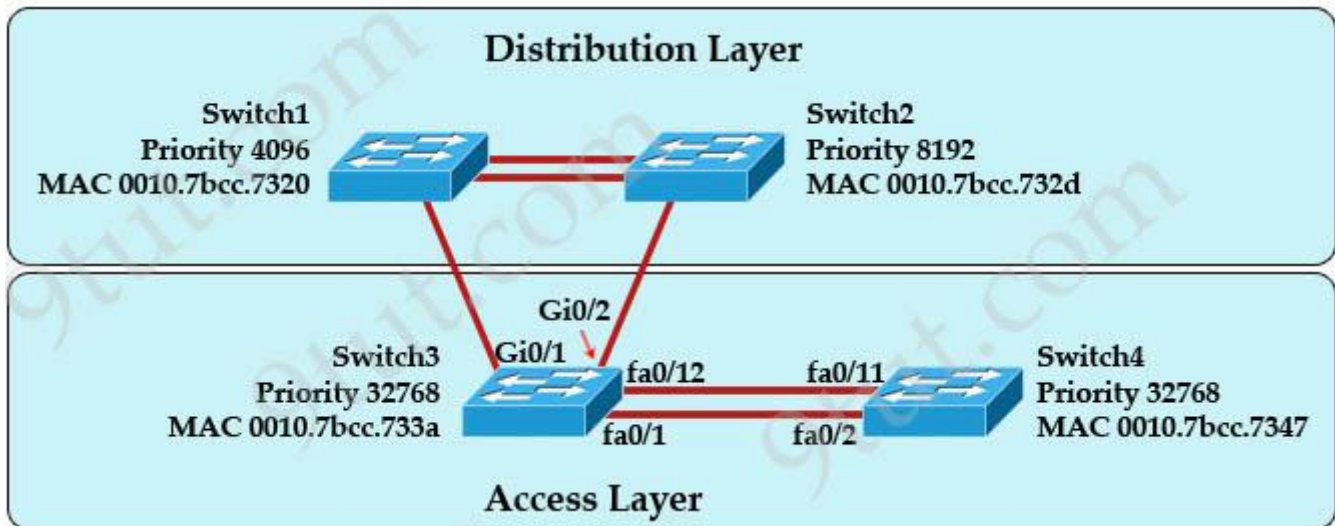

- A. Switch3, port fa0/1
- B. Switch3, port fa0/12
- C. Switch4, port fa0/11
- D. Switch4, port fa0/2
- E. Switch3, port Gi0/1

Answer: C

Question 9

Which option describes how a switch in rapid PVST+ mode responds to a topology change?

- A. It immediately deletes dynamic MAC addresses that were learned by all ports on the switch.
- B. It sets a timer to delete all MAC addresses that were learned dynamically by ports in the same STP instance.
- C. It sets a timer to delete dynamic MAC addresses that were learned by all ports on the switch.
- D. It immediately deletes all MAC addresses that were learned dynamically by ports in the same STP instance.

Answer: B

Question 10

Which RPVST+ port state is excluded from all STP operations?

- A. learning
- B. forwarding

- C. blocking
- D. disabled

Answer: D

Question 11

Which port state is introduced by Rapid-PVST?

- A. learning
- B. listening
- C. discarding
- D. forwarding

Answer: C

VTP Questions

<http://www.9tut.com/vtp-questions>

Question 1

Which protocol supports sharing the VLAN configuration between two or more switches?

- A. multicast
- B. STP
- C. VTP
- D. split-horizon

Answer: C

Question 2

How to enable VLANs automatically across multiple switches?

- A. Configure VLAN
- B. Configure NTP
- C. Configure each VLAN
- D. Configure VTP

Answer: D

Question 3

Which VTP mode can not make a change to vlan?

- A. Server
- B. Client
- C. Transparent
- D. Off

Answer: B

Question 4

Which DTP switch port mode allows the port to create a trunk link if the neighboring port is in trunk mode, or desirable auto mode?

- A. Dynamic auto
- B. Trunk
- C. Dynamic desirable
- D. Access

Answer: A

Question 5

To configure the VLAN trunking protocol to communicate VLAN information between two switches, what two requirements must be met? (Choose two)

- A. Each end of the trunk line must be set to IEEE 802.1E encapsulation.
- B. The VTP management domain name of both switches must be set the same.
- C. All ports on both the switches must be set as access ports.
- D. One of the two switches must be configured as a VTP server.
- E. A rollover cable is required to connect the two switches together.
- F. A router must be used to forward VTP traffic between VLANs.

Answer: B D

Question 6

What are the requirements for running VTP? (Choose two)

- A. VTP domain names must be different
- B. VTP domain names must be the same

- C. VTP server must have the highest revision numbers
- D. All devices need to have the same VTP version

Answer: B D

Port Security Questions

<http://www.9tut.com/port-security-questions>

Question 1

A network administrator needs to configure port security on a switch. Which two statements are true? (Choose two)

- A. The network administrator can apply port security to dynamic access ports
- B. The network administrator can configure static secure or sticky secure mac addresses in the voice vlan.
- C. The sticky learning feature allows the addition of dynamically learned addresses to the running configuration.
- D. The network administrator can apply port security to EtherChannels.
- E. When dynamic mac address learning is enabled on an interface, the switch can learn new addresses up to the maximum defined.

Answer: C E

Question 2

The network administrator normally establishes a Telnet session with the switch from host A. The administrator's attempt to establish a connect via Telnet to the switch from host B fails, but pings from host B to other two hosts are successful. What is the issue for this problem?

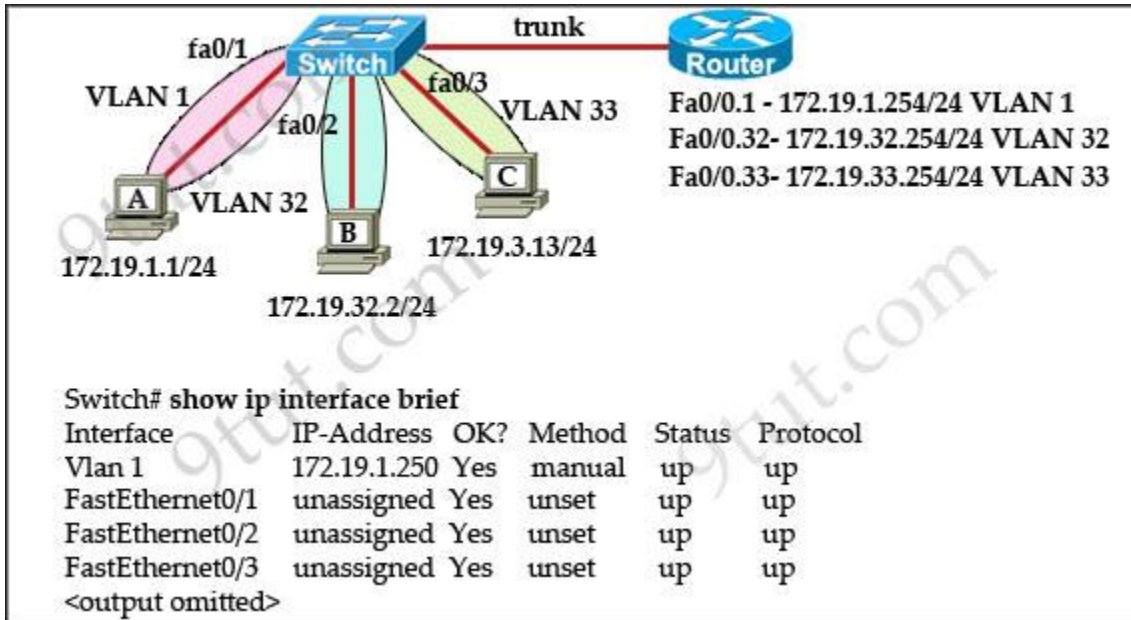

- A. Host B and the switch need to be in the same subnet.
- B. The switch needs an appropriate default gateway assigned.
- C. The switch interface connected to the router is down.
- D. Host B need to be assigned an IP address in vlan 1.

Answer: B

Question 3

Which option is the default switch port port-security violation mode?

- A. shutdown
- B. protect
- C. shutdown vlan
- D. restrict

Answer: A

Question 4

By default, how many MAC addresses are permitted to be learned on a switch port with port security enabled?

- A. 8
- B. 2
- C. 1
- D. 0

Answer: C

Question 5

Which set of commands is recommended to prevent the use of a hub in the access layer?

- A.
switch(config-if)#switchport mode trunk
switch(config-if)#switchport port-security maximum 1
- B.
switch(config-if)#switchport mode trunk
switch(config-if)#switchport port-security mac-address 1
- C.
switch(config-if)#switchport mode access
switch(config-if)#switchport port-security maximum 1
- D.
switch(config-if)#switchport mode access
switch(config-if)#switchport port-security mac-address 1

Answer: C

Question 6

Select the action that results from executing these commands:

```
Switch(config-if)# switchport port-security  
Switch(config-if)# switchport port-security mac-address sticky
```

- A. A dynamically learned MAC address is saved in the startup-configuration file.
- B. A dynamically learned MAC address is saved in the running-configuration file.
- C. A dynamically learned MAC address is saved in the VLAN database.
- D. Statically configured MAC addresses are saved in the startup-configuration file if frames from that address are received.
- E. Statically configured MAC addresses are saved in the running-configuration file if frames from that address are received.

Answer: B

Question 7

Refer to the exhibit. The following commands are executed on interface fa0/1 of 2950Switch.

```

2950Switch(config-if)#switchport port-security
2950Switch(config-if)#switchport port-security mac-address sticky
2950Switch(config-if)#switchport port-security maximum 1

```

The Ethernet frame that is shown arrives on interface fa0/1. What two functions will occur when this frame is received by 2950Switch? (Choose two)

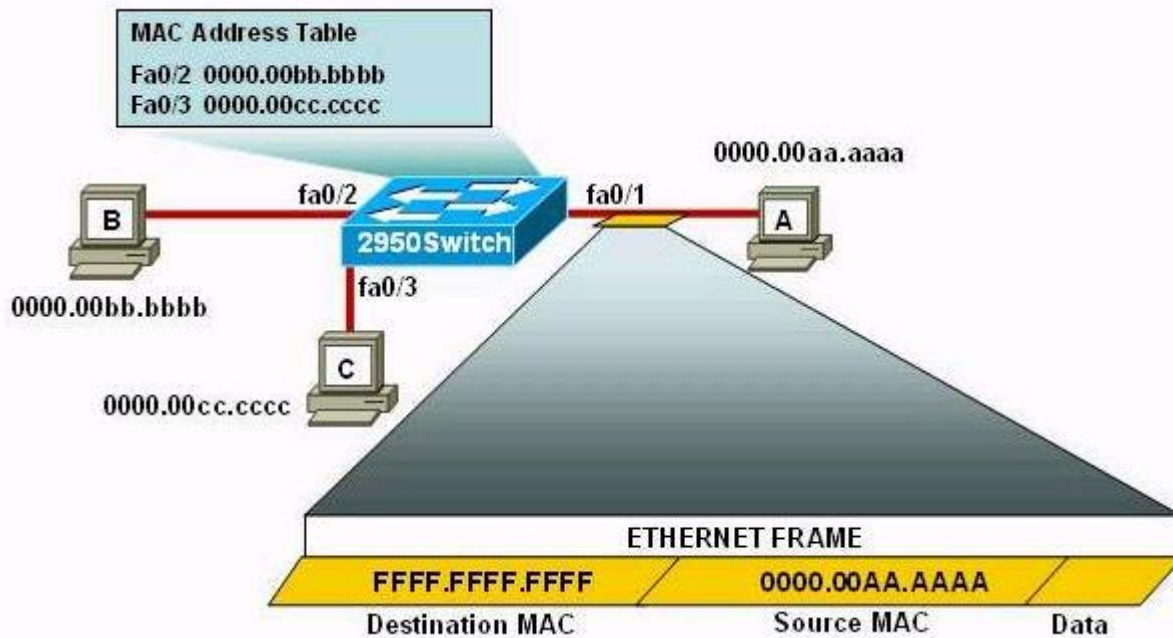

- A. The MAC address table will now have an additional entry of fa0/1 FFFF.FFFF.FFFF.
- B. Only host A will be allowed to transmit frames on fa0/1.
- C. This frame will be discarded when it is received by 2950Switch.
- D. All frames arriving on 2950Switch with a destination of 0000.00aa.aaaa will be forwarded out fa0/1.
- E. Hosts B and C may forward frames out fa0/1 but frames arriving from other switches will not be forwarded out fa0/1.
- F. Only frames from source 0000.00bb.bbbb, the first learned MAC address of 2950Switch, will be forwarded out fa0/1.

Answer: B D

Question 8

Which two commands correctly verify whether port security has been configured on port FastEthernet 0/12 on a switch? (Choose two)

- A. SW1# show switchport port-security interface FastEthernet 0/12
- B. SW1# show switchport port-secure interface FastEthernet 0/12
- C. SW1# show port-security interface FastEthernet 0/12
- D. SW1# show running-config

Answer: C D

Question 9

Refer to the exhibit. A junior network administrator was given the task of configuring port security on SwitchA to allow only PC_A to access the switched network through port fa0/1. If any other device is detected, the port is to drop frames from this device. The administrator configured the interface and tested it with successful pings from PC_A to RouterA, and then observes the output from these two show commands.

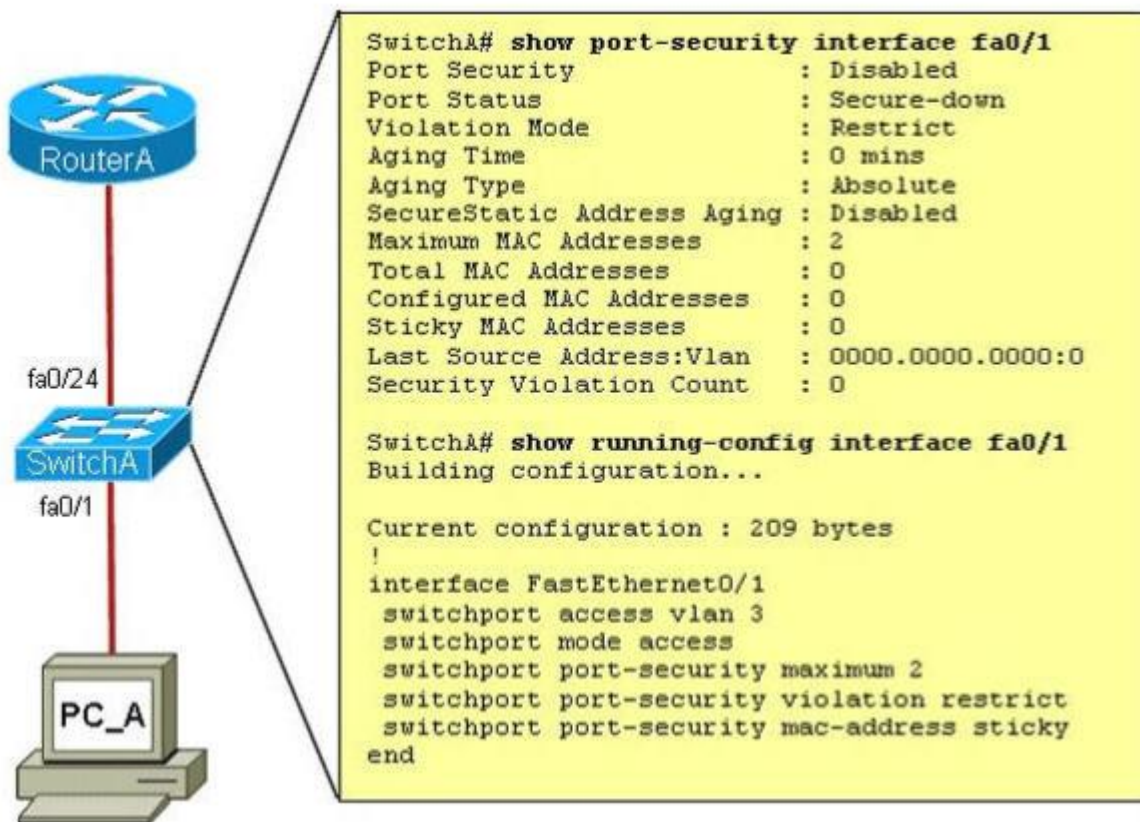

Which two of these changes are necessary for SwitchA to meet the requirements? (Choose two)

- A. Port security needs to be globally enabled.
- B. Port security needs to be enabled on the interface.
- C. Port security needs to be configured to shut down the interface in the event of a violation.
- D. Port security needs to be configured to allow only one learned MAC address.
- E. Port security interface counters need to be cleared before using the show command.
- F. The port security configuration needs to be saved to NVRAM before it can become active.

Answer: B D

Question 10

Which condition does the err-disabled status indicate on an Ethernet interface?

- A. There is a duplex mismatch.
- B. The device at the other end of the connection is powered off.
- C. The serial interface is disabled.
- D. The interface is configured with the shutdown command.
- E. Port security has disabled the interface.
- F. The interface is fully functioning.

Answer: E

Port Security Questions 2

<http://www.9tut.com/port-security-questions-2>

Question 1

Which port security mode can assist with troubleshooting by keeping count of violations?

- A. access
- B. protect
- C. restrict
- D. shutdown

Answer: C

Question 2

Which port security violation mode allows traffic from valid mac address to pass but block traffic from invalid MAC address?

- A. protect
- B. shutdown
- C. shutdown vlan
- D. restrict

Answer: A

Question 3

Which type of secure MAC address must be configured manually?

- A. dynamic
- B. bia
- C. static
- D. sticky

Answer: C

Question 4

Which command can you enter in a network switch configuration so that learned MAC addresses are saved in configuration as they connect?

- A. Switch(config-if)#switch port-security
- B. Switch(config-if)#switch port-security mac-address sticky
- C. Switch(config-if)#switch port-security maximum 10
- D. Switch(config-if)#switch mode access

Answer: B

SPAN Questions

<http://www.9tut.com/span-questions>

Question 1

Which feature can you use to monitor traffic on a switch by replicating it to another port or ports on the same switch?

- A. copy run start
- B. traceroute
- C. the ICMP Echo IP SLA
- D. SPAN

Answer: D

EtherChannel Questions

<http://www.9tut.com/etherchannel-questions>

Question 1

Refer to the exhibit. While troubleshooting a switch, you executed the “show interface port-channel 1 etherchannel” command and it returned this output. Which information is provided by the Load value?

Index	Load	Port	EC state	No of bits
0	36	Gi1/1	Active	3
1	84	Gi1/2	Active	3
2	16	Gi1/3	Active	2

- A. the percentage of use of the link
- B. the preference of the link
- C. the session count of the link
- D. the number source-destination pairs on the link

Answer: D

Question 2

What is the status of port-channel if LACP is misconfigured?

- A. Forwarding
- B. Enabled
- C. Disabled
- D. Errdisabled

Answer: C

Question 3

What parameter can be different on ports within an EtherChannel?

- A. speed
- B. DTP negotiation settings
- C. trunk encapsulation
- D. duplex

Answer: B

Question 4

Which option is the industry-standard protocol for EtherChannel?

- A. LACP
- B. PAGP
- C. Cisco Discovery Protocol
- D. DTP

Answer: A

Question 5

Which mode are in PAgP? (Choose two)

- A. Auto
- B. Desirable
- C. Active
- D. Passive
- E. On

Answer: A B

InterVLAN Routing

<http://www.9tut.com/intervlan-routing>

Question 1

Which type of device can be replaced by the use of subinterfaces for VLAN routing?

- A. Layer 2 bridge
- B. Layer 2 switch
- C. Layer 3 switch
- D. router

Answer: C

Question 2

Which technology can enable multiple VLANs to communicate with one another?

- A. inter-VLAN routing using a Layer 3 switch
- B. inter-VLAN routing using a Layer 2 switch
- C. intra-VLAN routing using router on a stick
- D. intra-VLAN routing using a Layer 3 switch

Answer: A

Question 3

Which configuration can you apply to enable encapsulation on a subinterface?

- A. interface FastEthernet 0/0
encapsulation dot1Q 30
ip address 10.1.1.30 255.255.255.0
- B. interface FastEthernet 0/0.30
ip address 10.1.1.30 255.255.255.0
- C. interface FastEthernet 0/0.30
description subinterface vlan 30
- D. interface FastEthernet 0/0.30
encapsulation dot1Q 30
ip address 10.1.1.30 255.255.255.0

Answer: D

Question 4

Which statement about slow inter VLAN forwarding is true?

- A. The VLAN is experiencing slowness in the point-to-point collisionless connection.
- B. The VLANs are experiencing slowness because multiple devices are connected to the same hub.
- C. The local VLAN is working normally, but traffic to the alternate VLAN is forwarded slower than expected.
- D. The entire VLAN is experiencing slowness.
- E. The VLANs are experiencing slowness due to a duplex mismatch.

Answer: E

Question 5

Which function enables an administrator to route multiple VLANs on a router?

- A. IEEE 802.1X
- B. HSRP
- C. port channel
- D. router on a stick

Answer: D

Question 6

Which statement about a router on a stick is true?

- A. Its data plane router traffic for a single VLAN over two or more switches.
- B. It uses multiple subinterfaces of a single interface to encapsulate traffic for different VLANs on the same subnet.
- C. It requires the native VLAN to be disabled.
- D. It uses multiple subinterfaces of a single interface to encapsulate traffic for different VLANs.

Answer: D

Question 7

Refer to the exhibit:

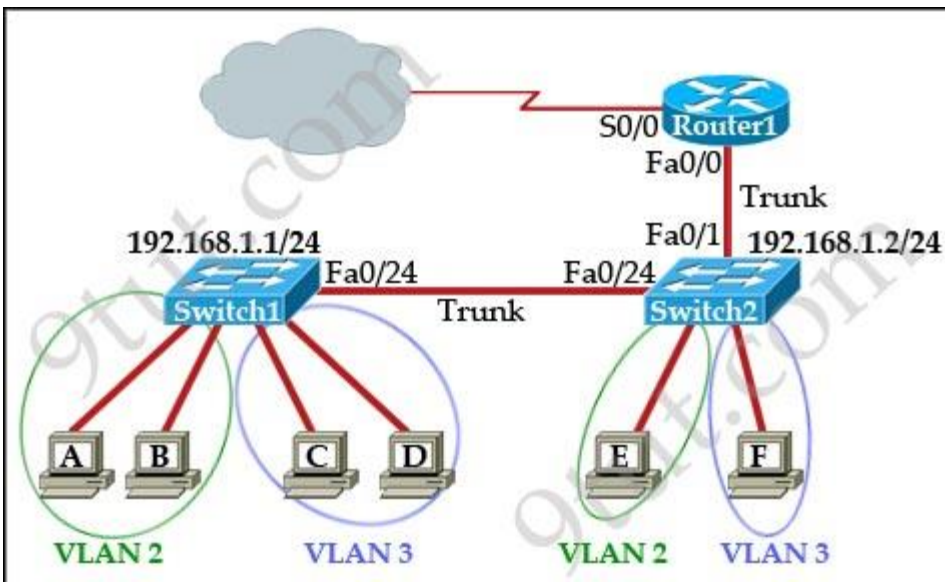

Which two statements are true about interVLAN routing in the topology that is shown in the exhibit?
(Choose two)

- A. Host E and host F use the same IP gateway address.
- B. Router1 and Switch2 should be connected via a crossover cable.
- C. Router1 will not play a role in communications between host A and host D.
- D. The FastEthernet 0/0 interface on Router1 must be configured with subinterfaces.
- E. Router1 needs more LAN interfaces to accommodate the VLANs that are shown in the exhibit.
- F. The FastEthernet 0/0 interface on Router1 and Switch2 trunk ports must be configured using the same encapsulation type.

Answer: D F

Question 8

Which two steps must you perform to enable router-on-stick on a switch?

- A. connect the router to a trunk port
- B. configure the subinterface number exactly the same as the matching VLAN
- C. configure full duplex
- D. configure an ip route to the vlan destination network
- E. assign the access port to the vlan

Answer: A E

Question 9

The network shown in the diagram is experiencing connectivity problems. Which of the following will correct the problems? (Choose two)

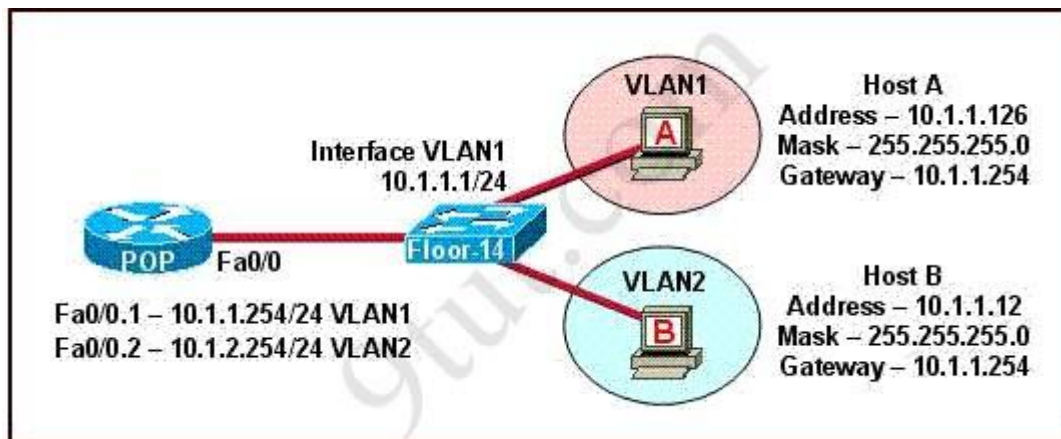

- A. Configure the gateway on Host A as 10.1.1.1.
- B. Configure the gateway on Host B as 10.1.2.254.
- C. Configure the IP address of Host A as 10.1.2.2.
- D. Configure the IP address of Host B as 10.1.2.2.
- E. Configure the masks on both hosts to be 255.255.255.224.
- F. Configure the masks on both hosts to be 255.255.255.240.

Answer: B D

Question 10

Under which circumstance is a router on a stick most appropriate?

- A. When a router have multiple subnets on a single physical link
- B. When a router have single subnet on multiple physical links
- C. When a router have multiple interface on single physical links
- D. When a router have single interface on multiple physical links

Answer: A

Question 11

Which functionality does an SVI provide?

- A. OSI Layer 2 connectivity to switches
- B. remote switch administration
- C. traffic routing for VLANs
- D. OSI Layer 3 connectivity to switches

Answer: C

Question 12

To enable router on a stick on a router subinterface, which two steps must you perform? (Choose two)

- A. configure full duplex and speed
- B. configure a default to route traffic between subinterfaces
- C. configure the subinterface with an IP address
- D. configure encapsulation dot1q
- E. configure an ip route to the vlan destination network

Answer: C D

Router Questions

<http://www.9tut.com/router-questions>

Question 1

Which step in the router boot process searches for an IOS image to load into the router?

- A. bootstrap
- B. POST
- C. mini-IOS
- D. ROMMON mode

Answer: A

Question 2

If a router has four interfaces and each interface is connected to four switches, how many broadcast domains are present on the router?

- A. 1
- B. 2
- C. 4
- D. 8

Answer: C

Question 3

What is the purpose of the POST operation on a router?

- A. determine whether additional hardware has been added
- B. locate an IOS image for booting
- C. enable a TFTP server
- D. set the configuration register

Answer: A

Question 4

Which command can you execute to set the user inactivity timer to 10 seconds?

- A. SW1(config-line)#exec-timeout 0 10
- B. SW1(config-line)#exec-timeout 10
- C. SW1(config-line)#absolute-timeout 0 10
- D. SW1(config-line)#absolute-timeout 10

Answer: A

Question 5

After you configure the Loopback0 interface, which command can you enter to verify the status of the interface and determine whether fast switching is enabled?

- A. Router#show ip interface loopback 0
- B. Router#show run
- C. Router#show interface loopback 0
- D. Router#show ip interface brief

Answer: A

Question 6

A Cisco router is booting and has just completed the POST process. It is now ready to find and load an IOS image. What function does the router perform next?

- A. It checks the configuration register
- B. It attempts to boot from a TFTP server
- C. It loads the first image file in flash memory
- D. It inspects the configuration file in NVRAM for boot instructions

Answer: A

Question 7

Which command is used to show the interface status of a router?

- A. show interface status
- B. show ip interface brief
- C. show ip route
- D. show interface

Answer: B

Question 8

Which of the following privilege level is the most secured?

- A. Level 0
- B. Level 1
- C. Level 15
- D. Level 16

Answer: C

Question 9

What to do when the router password was forgotten?

- A. use default password cisco to reset
- B. access router physically
- C. use ssl/vpn
- D. Type confreg 0x2142 at the rommon 1

Answer: D

Question 10

How do you configure a hostname?

- A. Router(config)#hostname R1
- B. Router#hostname R1
- C. Router(config)#host name R1
- D. Router>hostname R1

Answer: A

Question 11

Which two Cisco IOS commands, used in troubleshooting, can enable debug output to a remote location? (Choose two)

- A. no logging console
- B. logging host ip-address
- C. terminal monitor
- D. show logging | redirect flash:output.txt
- E. snmp-server enable traps syslog

Answer: B C

Question 12

Which statement about recovering a password on a Cisco router is true?

- A. The default reset password is cisco
- B. It requires a secure SSL/VPN connection
- C. A factory reset is required if you forget the password
- D. It requires physical access to the router

Answer: D

Question 13

Refer to the exhibit. Why is flash memory erased prior to upgrading the IOS image from the TFTP server?

```
Router# copy tftp flash
Address or name of remote host []? 192.168.2.167
Source filename []? c1600-k8sy-mz.123-16a.bin
Destination filename [c1600-k8sy-mz.123-16a.bin]?
Accessing tftp://192.168.2.167/ c1600-k8sy-mz.123-16a.bin...
Erasing flash before copying? [confirm]
Erasing the flash filesystem will remove all files! continue? [confirm]
Erasing device
Eeeeeeeeeeeeeeeeeeeeeeeeeeeeeeeeeeeeeeeeeeeeeeeeeeeeeeeeeeeeeeeeeeeeeeeee
Eeeeeeeeeeeeeeeeeeeeeeeeeeeeeeeeeeeeeeeeeeeeeeeeeeeeeeeeeeeeeeeeeeeeeeeee
...erased
Erase of flash: complete
Loading c1600-k8sy-mz.123-16a.bin from 192.168.2.167 (via Ethernet0):
!!!!!!!!!!!!!!!!!!!!!!!!!!!!!!!!!!!!!!!!!!!!!!!!!!!!!!!!!!!!!!!!!!!!!!!!!!!!!!
!!!!!!!!!!!!!!!!!!!!!!!!!!!!!!!!!!!!!!!!!!!!!!!!!!!!!!!!!!!!!!!!!!!!!!!!!!!!!!
!!!!!!!!!!!!!!!!!!!!!!!!!!!!!!!!!!!!!!
[OK - 6888962/13777920 bytes]

verifying checksum... OK (0x7BF3)
6888962 bytes copied in 209.920 secs (32961 bytes/sec)
Router#
```

- A. The router cannot verify that the Cisco IOS image currently in flash is valid
- B. Flash memory on Cisco routers can contain only a single IOS image.
- C. Erasing current flash content is requested during the copy dialog.
- D. In order for the router to use the new image as the default, it must be the only IOS image in flash.

Answer: C

Question 14

In which CLI configuration mode can you configure the hostname of a device?

- A. line mode
- B. interface mode
- C. global mode
- D. router mode

Answer: C

Question 15

Which three commands can you use to set a router boot image? (Choose three)

- A. Router(config)# boot system flash c4500-p-mz.121-20.bin
- B. Router(config)# boot system tftp c7300-js-mz.122-33.SB8a.bin
- C. Router(config)#boot system rom c7301-advipservicesk9-mz.124-24.T4.bin
- D. Router> boot flash:c180x-adventerprisek9-mz-124-6T.bin
- E. Router(config)#boot flash:c180x-adventerprisek9-mz-124-6T.bin
- F. Router(config)#boot bootldr bootflash:c4500-jk9s-mz.122-23f.bin

Answer: A B C

Switch Stacking & Chassis Aggregation

<http://www.9tut.com/switch-stacking-chassis-aggregation>

Question 1

Which option is a benefit of switch stacking?

- A. It provides redundancy with no impact on resource usage.
- B. It simplifies adding and removing hosts.
- C. It supports better performance of high-needs applications.
- D. It provides higher port density with better resource usage.

Answer: D

Question 2

Which two options describe benefits of aggregated chassis technology? (Choose two)

- A. It reduces management overhead
- B. Switches can be located anywhere regardless of their physical location
- C. It requires only one IP address per VLAN
- D. It requires only three IP addresses per VLAN
- E. It supports HSRP VRRP GLBP
- F. It supports redundant configuration files

Answer: A C

Question 3

How is master redundancy provided on a stacked switches?

- A. 1:N
- B. N:1
- C. 1:1
- D. 1+N
- E. N+1

Answer: A

Access list Questions

<http://www.9tut.com/access-list-questions>

Question 1

Which identification number is valid for an extended ACL?

- A. 1
- B. 64
- C. 99
- D. 100
- E. 299
- F. 1099

Answer: D

Question 2

Which statement about named ACLs is true?

- A. They support standard and extended ACLs.
- B. They are used to filter usernames and passwords for Telnet and SSH.
- C. They are used to filter Layer 7 traffic.
- D. They support standard ACLs only.
- E. They are used to rate limit traffic destined to targeted networks.

Answer: A

Question 3

Which range represents the standard access list?

- A. 99
- B. 150
- C. 299
- D. 2000

Answer: A

Question 4

A network engineer wants to allow a temporary entry for a remote user with a specific username and password so that the user can access the entire network over the internet. Which ACL can be used?

- A. reflexive
- B. extended
- C. standard
- D. dynamic

Answer: D

Question 5

Which statement about ACLs is true?

- A. An ACL have must at least one permit action, else it just blocks all traffic.
- B. ACLs go bottom-up through the entries looking for a match
- C. An ACL has a an implicit permit at the end of ACL.
- D. ACLs will check the packet against all entries looking for a match.

Answer: A

Question 6

Which action can change the order of entries in a named access-list?

- A. removing an entry
- B. opening the access-list in notepad
- C. adding an entry
- D. resequencing

Answer: D

Question 7

Which of the following are the valid numbers of standard ACL? (Choose two)

- A. 50
- B. 1550
- C. 150
- D. 1250
- E. 2050

Answer: A B

Question 8

Host is able to ping a web server but it is not able to do HTTP request. What is the most likely cause the problem?

- A. ACL blocking port 23
- B. ACL blocking all ports
- C. ACL blocking port 80
- D. ACL blocking port 443
- E. None of the above

Answer: C

Question 9

Which item represents the standard IP ACL?

- A. Access-list 110 permit any any
- B. Access-list 50 deny 192.168.1.1 0.0.0.255
- C. Access list 101 deny tcp any host 192.168.1.1
- D. Access-list 2500 deny tcp any host 192.168.1.1 eq 22

Answer: B

Question 10

While troubleshooting a connection problem on a computer, you determined that the computer can ping a specific web server but it cannot connect to TCP port 80 on that server. Which reason for the problem is most likely true?

- A. A VLAN number is incorrect
- B. An ARP table entry is missing
- C. A route is missing
- D. An ACL is blocking the TCP port

Answer: D

Question 11

Which command can you enter to block HTTPS traffic from the whole class A private network range to a host?

- A. R1(config)#access-list 105 deny tcp 10.1.0.0 0.0.255.255 40.0.0.2 0.0.0.0 eq 443
- B. R1(config)#access-list 105 deny tcp 10.1.0.0 0.0.255.255 40.0.0.2 0.0.0.0 eq 53
- C. R1(config)#access-list 105 deny tcp 10.0.0.0 0.255.255.255 40.0.0.2 0.0.0.0 eq 53
- D. R1(config)#access-list 105 deny tcp 10.0.0.0 0.255.255.255 40.0.0.2 0.0.0.0 eq 443

Answer: D

IP Routing

<http://www.9tut.com/ip-routing>

Question 1

A router has learned three possible routes that could be used to reach a destination network. One route is from EIGRP and has a composite metric of 20514560. Another route is from OSPF with a metric of 782. The last is from RIPv2 and has a metric of 4. Which route or routes will the router install in the routing table?

- A. the RIPv2 route
- B. all three routes
- C. the OSPF and RIPv2 routes
- D. the OSPF route
- E. the EIGRP route

Answer: E

Question 2

Which command can you enter to route all traffic that is destined for 192.168.0.0/20 to a specific interface?

- A. router(config)#ip route 192.168.0.0 255.255.240.0 GigabitEthernet0/1
- B. router(config)#ip route 0.0.0.0 255.255.255.0 GigabitEthernet0/1
- C. router(config)#ip route 0.0.0.0 0.0.0.0 GigabitEthernet0/1
- D. router(config)#ip route 192.168.0.0 255.255.255.0 GigabitEthernet0/1

Answer: A

Question 3

Which command can you enter to set the default route for all traffic to an interface?

- A. router(config)#ip route 0.0.0.0 0.0.0.0 GigabitEthernet0/1
- B. router(config)#ip route 0.0.0.0 255.255.255.255 GigabitEthernet0/1
- C. router(config-router)#default-information originate
- D. router(config-router)#default-information originate always

Answer: A

Question 4

Which three statements about static routing are true? (Choose three)

- A. It uses consistent route determination.
- B. It is best used for small-scale deployments.
- C. Routing is disrupted when links fail.
- D. It requires more resources than other routing methods.
- E. It is best used for large-scale deployments.
- F. Routers can use update messages to reroute when links fail.

Answer: A B C

Question 5

If host Z needs to send data through router R1 to a storage server, which destination MAC address does host Z use to transmit packets?

- A. the host Z MAC address
- B. the MAC address of the interface on R1 that connects to the storage server
- C. the MAC address of the interface on R1 that connects to host Z
- D. the MAC address of the storage server interface

Answer: C

Question 6

Which routing protocol has the smallest default administrative distance?

- A. IBGP
- B. OSPF
- C. IS-IS
- D. EIGRP
- E. RIP

Answer: D

Question 7

Which statement about static routes is true?

- A. The source interface can be configured to make routing decisions.
- B. A subnet mask is entered for the next-hop address.
- C. The subnet mask is 255.255.255.0 by default
- D. The exit interface can be specified to indicate where the packets will be routed.

Answer: D

Question 8

Which component of a routing table entry represents the subnet mask?

- A. routing protocol code
- B. prefix
- C. metric
- D. network mask

Answer: D

Question 9

When a router makes a routing decision for a packet that is received from one network and destined to another, which portion of the packet does it replace?

- A. Layer 2 frame header and trailer
- B. Layer 3 IP address
- C. Layer 5 session
- D. Layer 4 protocol

Answer: A

Question 10

Which statement about routing protocols is true?

- A. Link-state routing protocols choose a path by the number of hops to the destination.
- B. OSPF is a link-state routing protocol.
- C. Distance-vector routing protocols use the Shortest Path First algorithm.
- D. IS-IS is a distance-vector routing protocol.

Answer: B

Question 11

Which dynamic routing protocol uses only the hop count to determine the best path to a destination?

- A. IGRP
- B. RIP
- C. EIGRP
- D. OSPF

Answer: B

IP Routing 2

<http://www.9tut.com/ip-routing-2>

Question 1

Which value is indicated by the next hop in a routing table?

- A. preference of the route source
- B. IP address of the remote router for forwarding the packets
- C. how the route was learned
- D. exit interface IP address for forwarding the packets

Answer: B

Question 2

Which component of the routing table ranks routing protocols according to their preferences?

- A. administrative distance
- B. next hop
- C. metric
- D. routing protocol code

Answer: A

Question 3

Which route source code represents the routing protocol with a default administrative distance of 90 in the routing table?

- A. S
- B. E
- C. D
- D. R
- E. O

Answer: C

Question 4

When enabled, which feature prevents routing protocols from sending hello messages on an interface?

- A. virtual links
- B. passive-interface
- C. directed neighbors
- D. OSPF areas

Answer: B

Question 5

How does a router handle an incoming packet whose destination network is missing from the routing table?

- A. It broadcast the packet to each interface on the router
- B. It discards the packet
- C. It broadcasts the packet to each network on the router
- D. It routes the packet to the default route

Answer: B

Question 6

Which path does a router choose when it receives a packet with multiple possible paths to the destination over different routing protocols?

- A. the path with both the lowest administrative distance and the highest metric
- B. the path with the lowest administrative distance
- C. the path with the lowest metric
- D. the path with both the lowest administrative distance and lowest metric

Answer: B

Question 7

If a route is not present in the routing table for a particular destination, what would the router do?

- A. Default route
- B. Flood
- C. Drop

Answer: C

Question 8

When a device learns multiple routes to a specific network, it installs the route with?

- A. longest bit match (highest subnet mask)
- B. lowest AD
- C. lowest metric
- D. equal load balancing

Answer: B

Question 9

When a router is unable to find a known route in the routing table, how does it handle the packet?

- A. It discards the packet
- B. It sends the packet over the route with the best metric

- C. It sends the packet to the next hop address
- D. It sends the packet to the gateway of last resort

Answer: A

Question 10

If router R1 knows a static route to a destination network and then learns about the same destination network through a dynamic routing protocol, how does R1 respond?

- A. It refuses to advertise the dynamic route to other neighbors
- B. It sends a withdrawal signal to the neighboring router
- C. It disables the routing protocol
- D. It prefers the static route

Answer: D

IP Routing 3

<http://www.9tut.com/ip-routing-3>

Question 1

Which two statements about floating static routes are true? (Choose two)

- A. They are routes to the exact /32 destination address
- B. They are used when a route to the destination network is missing
- C. They have a higher administrative distance than the default static route administrative distance
- D. They are used as back-up routes when the primary route goes down
- E. They are dynamic routes that are learned from a server

Answer: C D

Question 2

Which definition of a host route is true?

- A. A route that is manually configured
- B. A route used when a destination route is missing
- C. A route to the exact /32 destination address
- D. Dynamic route learned from the server

Answer: C

Question 3

When troubleshooting Ethernet connectivity issues, how can you verify that an IP address is known to a router?

- A. Check whether the IP address is in the routing table
- B. Check whether an ACL is blocking the IP address
- C. Check whether the IP address is in the CAM table
- D. Check whether the IP address is in the ARP table

Answer: D

Question 4

If Computer A is sending traffic to computer B, which option is the source IP address when a packet leaves R1 on interface F0/1?

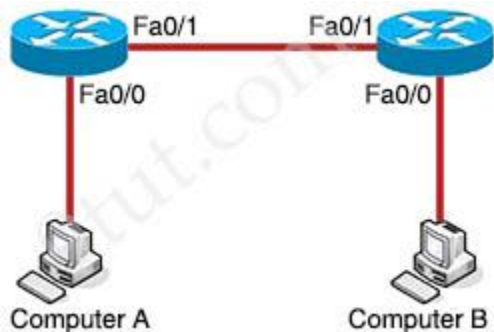

- A. IP address of the R2 interface F0/1
- B. IP address of computer B
- C. IP address of R1 interface F0/1
- D. IP address of Computer A

Answer: D

Question 5

When is a routing table entry identified as directly connected?

- A. When the local router is in use as the network default gateway
- B. When the network resides on a remote router that is physically connected to the local router
- C. When an interface on the router is configured with an IP address and enabled
- D. When the route is statically assigned to reach a specific network

Answer: C

Question 6

Router R1 has a static route that is configured to a destination network. A directly connected interface is configured with an IP address in the same destination network. Which statement about R1 is true?

- A. It refuses to advertise the dynamic route to other neighbors
- B. It sends a withdrawal signal to the neighboring router
- C. It disables the routing protocol
- D. It prefers the static route

Answer: D

Subnetting Questions

<http://www.9tut.com/subnetting-questions>

Question 1

Refer to the exhibit. All of the routers in the network are configured with the ip subnet-zero command. Which network addresses should be used for Link A and Network A? (Choose two)

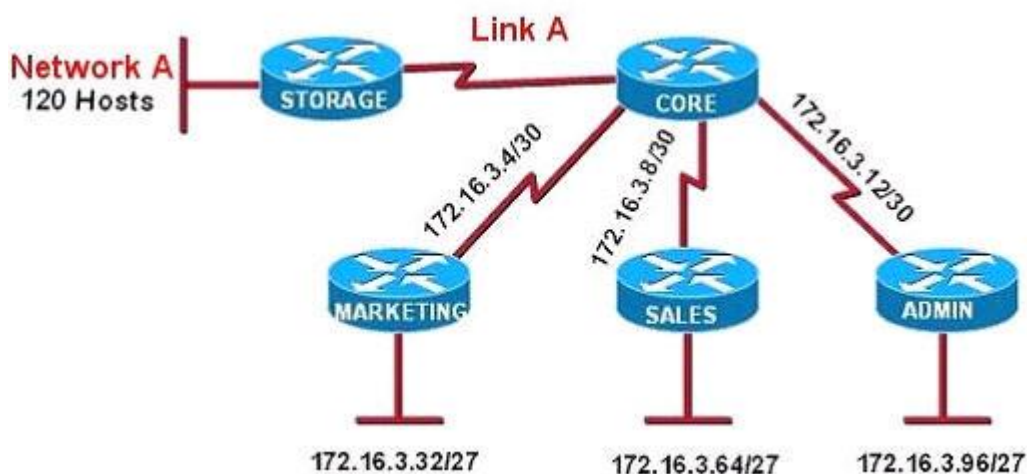

- A. Network A – 172.16.3.48/26
- B. Network A – 172.16.3.128/25
- C. Network A – 172.16.3.192/26
- D. Link A – 172.16.3.0/30
- E. Link A – 172.16.3.40/30
- F. Link A – 172.16.3.112/30

Answer: B D

Question 2

What is the correct routing match to reach 172.16.1.5/32?

- A. 172.16.1.0/26
- B. 172.16.1.0/25
- C. 172.16.1.0/24
- D. the default route

Answer: A

Question 3

You have been asked to come up with a subnet mask that will allow all three web servers to be on the same network while providing the maximum number of subnets. Which network address and subnet mask meet this requirement?

- A. 192.168.252.0 255.255.255.252
- B. 192.168.252.8 255.255.255.248
- C. 192.168.252.8 255.255.255.252
- D. 192.168.252.16 255.255.255.240
- E. 192.168.252.16 255.255.255.252

Answer: B

Question 4

Refer to the exhibit. What is the most appropriate summarization for these routes?

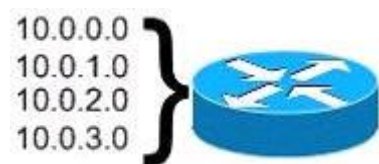

- A. 10.0.0.0/21
- B. 10.0.0.0/22
- C. 10.0.0.0/23
- D. 10.0.0.0/24

Answer: B

Question 5

How many usable hosts are there per subnet if you have the address of 192.168.10.0 with a subnet mask of 255.255.255.240?

- A. 4
- B. 8
- C. 16
- D. 14

Answer: D

Question 6

Assuming a subnet mask of 255.255.248.0, three of the following addresses are valid host addresses. Which are these addresses? (Choose three)

- A. 172.16.9.0
- B. 172.16.8.0
- C. 172.16.31.0
- D. 172.16.20.0

Answer: A C D

Question 7

Which IP configuration does the CIDR notation 192.168.1.1/25 refer?

- A. 192.168.1.1 255.255.255.64
- B. 192.168.1.1 255.255.255.1
- C. 192.168.1.1 255.255.255.32
- D. 192.168.1.1 255.255.255.256
- E. 192.168.1.1 255.255.255.128

Answer: E

Question 8

CIDR notation (255.255.255.252) in “/” notation

- A. 30
- B. 31

- C. 32
- D. 33

Answer: A

Question 9

Refer to the exhibit:

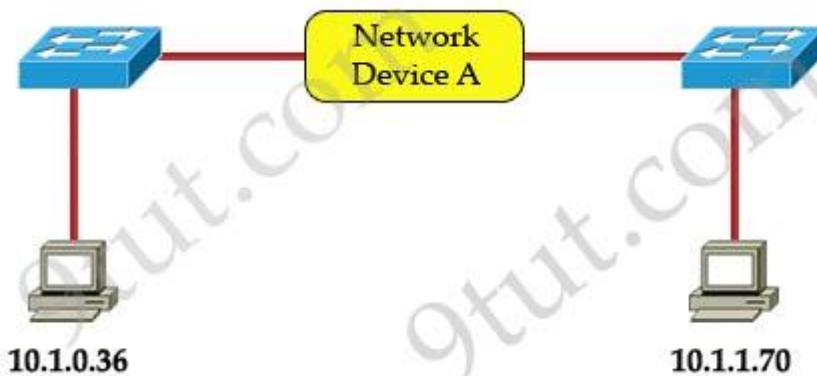

Which three statements correctly describe Network Device A? (Choose three)

- A. With a network wide mask of 255.255.255.128, each interface does not require an IP address.
- B. With a network wide mask of 255.255.255.128, each interface does require an IP address on a unique IP subnet.
- C. With a network wide mask of 255.255.255.0, must be a Layer 2 device for the PCs to communicate with each other.
- D. With a network wide mask of 255.255.255.0, must be a Layer 3 device for the PCs to communicate with each other.
- E. With a network wide mask of 255.255.254.0, each interface does not require an IP address.

Answer: B D E

Question 10

Refer to the exhibit, you determine that Computer A cannot ping Computer B. Which reason for the problem is most likely true?

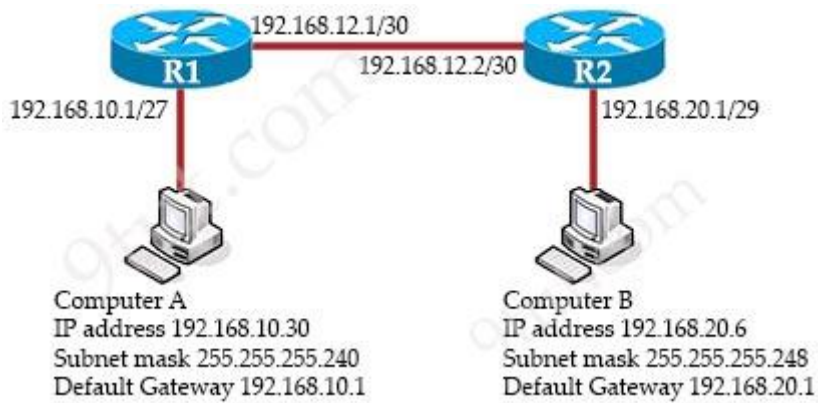

- A. The Subnet mask for Computer A is incorrect
- B. The default gateway address for Computer A is incorrect
- C. The subnet mask for computer B is incorrect.
- D. The default gateway address for computer B is incorrect

Answer: A

Question 11

For which two reasons was RFC 1918 address space define (Choose two)

- A. to preserve public IPv4 address space
- B. to reduce the occurrence of overlapping IP addresses
- C. to preserve public IPv6 address space
- D. reduce the size of ISP routing tables
- E. to support the NAT protocol

Answer: A B

RIP Questions

<http://www.9tut.com/rip-questions>

Question 1

How to configure RIPv2? (Choose two)

- A. Enable RIP
- B. Connect RIP to WAN interface
- C. Enable auto-summary
- D. Enable authentication

Answer: A ?

Question 2

Which two options are requirements for configuring RIPv2 for IPv4 (Choose two)?

- A. enabling RIP authentication
- B. connecting RIP to a WAN Interface
- C. enabling auto route summarization
- D. allowing unicast updates for RIP
- E. enabling RIP on the router

Answer: D E

Question 3

What does split-horizon do?

- A. Prevent routing loop in distance vector protocol
- B. Prevent switching loop in distance vector protocol
- C. Prevent switching loop in link-state protocol
- D. Prevent routing loop in link-state protocol

Answer: A

Question 4

Which effect of the passive-interface command on R1 is true?

```
R1
interface FastEthernet0/0
description site id:14254489
ip address 172.16.0.1 255.255.0.0

interface FastEthernet0/1
description site id:14254489
ip address 172.17.0.1 255.255.0.0

router rip
passive-interface FastEthernet0/0
network 172.16.0.0
network 172.17.0.0
version 2
```

- A. It prevents interface Fa0/0 from sending updates.
- B. Interface Fa0/0 operates in RIPv1 mode.

- C. It removes the 172.16.0.0 network from all updates on all interfaces on R1.
- D. It removes the 172.17.0.0 network from all updates on all interfaces on R1.

Answer: A

Question 5

Which type of routing protocol operates by exchanging the entire routing information?

- A. distance vector protocols
- B. link state protocols
- C. path vector protocols
- D. exterior gateway protocols

Answer: A

Question 6

Refer to the exhibit. After you apply the given configuration to R1, you determine that it is failing to advertise the 172.16.10.32/28 network. Which action most likely to correct the problem?

```
R1
interface FastEthernet0/0
 ip address 172.16.10.1 255.255.255.224

interface FastEthernet0/1
 ip address 172.16.10.33 255.255.255.240

router rip
 network 172.16.0.0
 no auto-summary
```

- A. Enable passive interface
- B. Enable RIPv2
- C. Enable manual summarization
- D. Enable autosummarization

Answer: B

Question 7

Which two statements about RIPv2 are true? (Choose two)

- A. It must be manually enabled after RIP is configured as the routing protocol
- B. It uses multicast address 224.0.0.2 to share routing information between peers
- C. Its default administrative distances 120
- D. It is a link-state routing protocol
- E. It is an EGP routing protocol

Answer: A C

OSPF Questions

<http://www.9tut.com/ospf-questions>

Question 1

Which three statements about link-state routing are true? (Choose three)

- A. It uses split horizon.
- B. Updates are sent to a broadcast address.
- C. RIP is a link-state protocol.
- D. Updates are sent to a multicast address by default.
- E. Routes are updated when a change in topology occurs.
- F. OSPF is a link-state protocol.

Answer: D E F

Question 2

Which three characteristics are representative of a link-state routing protocol? (Choose three)

- A. provides common view of entire topology
- B. exchanges routing tables with neighbors
- C. calculates shortest path
- D. utilizes event-triggered updates
- E. utilizes frequent periodic updates

Answer: A C D

Question 3

What are two drawbacks of implementing a link-state routing protocol? (Choose two)

- A. the sequencing and acknowledgment of link-state packets
- B. the high volume of link-state advertisements in a converged network

- C. the requirement for a hierarchical IP addressing scheme for optimal functionality
- D. the high demand on router resources to run the link-state routing algorithm
- E. the large size of the topology table listing all advertised routes in the converged network

Answer: C D

Question 4

Refer to the exhibit. Router edge-1 is unable to establish OSPF neighbor adjacency with router ISP-1. Which two configuration changes can you make on edge-1 to allow the two routers to establish adjacency? (Choose two)



- A. Set the subnet mask on edge-1 to 255 255.255.252.
- B. Reduce the MTU on edge-1 to 1514.
- C. Set the OSPF cost on edge-1 to 1522.
- D. Reduce the MTU on edge-1 to 1500.
- E. Configure the ip ospf mtu-ignore command on the edge-1 Gi0/0 interface.

Answer: D E

Question 5

A network administrator is troubleshooting the OSPF configuration of routers R1 and R2. The routers cannot establish an adjacency relationship on their common Ethernet link. The graphic shows the output of the show ip ospf interface e0 command for routers R1 and R2. Based on the information in the graphic, what is the cause of this problem?

```

R1: Ethernet0 is up, line protocol is up
    Internet address 192.168.1.2/24, Area 0
    Process ID 1, Router ID 192.168.31.33, Network Type BROADCAST, Cost: 10
    Transmit Delay is 1 sec, State DR, Priority 1
    Designated Router (ID) 192.168.31.33, Interface address 192.168.1.2
    No backup designated router on this network
    Timer intervals configured, Hello 5, Dead 20, Wait 20, Retransmit 5

R2: Ethernet0 is up, line protocol is up
    Internet address 192.168.1.1/24, Area 0
    Process ID 2, Router ID 192.168.31.11, Network Type BROADCAST, Cost: 10
    Transmit Delay is 1 sec, State DR, Priority 1
    Designated Router (ID) 192.168.31.11, Interface address 192.168.1.1
    No backup designated router on this network
    Timer intervals configured, Hello 10, Dead 40, Wait 40, Retransmit 5

```

- A. The OSPF area is not configured properly.
- B. The priority on R1 should be set higher.
- C. The cost on R1 should be set higher.
- D. The hello and dead timers are not configured properly.
- E. A backup designated router needs to be added to the network.
- F. The OSPF process ID numbers must match.

Answer: D

Question 6

What routing protocol use first-hand information?

- A. link-state
- B. distance-vector
- C. path-vector
- D. other

Answer: A

Question 7

Refer to the exhibit. If R1 sends traffic to 192.168.10.45 the traffic is sent through which interface?

```
R1#show ip route
```

```
Codes: C - connected, S - static, R - RIP, M - mobile, B - BGP  
D - EIGRP, EX - EIGRP external, O - OSPF, IA - OSPF inter area  
N1 - OSPF NSSA external type 1, N2 - OSPF NSSA external type 2  
E1 - OSPF external type 1, E2 - OSPF external type 2  
i - IS-IS, su - IS-IS summary, L1 - IS-IS level-1, L2 - IS-IS level-2  
ia - IS-IS inter area, * - candidate default,  
o - ODR, P - periodic downloaded static route, H - NHRP, l - LISP
```

```
Gateway of last resort is 192.168.14.4 to network 0.0.0.0
```

```
C 192.168.12.0/24 is directly connected, FastEthernet0/0  
C 192.168.13.0/24 is directly connected, FastEthernet0/1  
C 192.168.14.0/24 is directly connected, FastEthernet1/0  
192.168.10.0/24 is variably subnetted, 3 subnets, 3 masks  
O 192.168.10.0/24 [110/2] via 192.168.14.4, 00:02:00, FastEthernet1/0  
O 192.168.10.32/27 [110/11] via 192.168.13.3, 00:00:51, FastEthernet0/1  
O 192.168.0.0/16 [110/2] via 192.168.15.5, 00:02:00, FastEthernet1/1  
D 192.168.10.1/32 [50/52778] via 192.168.12.2, 00:02:00, FastEthernet0/0  
O*E2 0.0.0.0/0 [110/1] via 192.168.14.4, 01:35:54, FastEthernet1/0
```

- A. FastEthernet0/1
- B. FastEthernet0/0
- C. FastEthernet1/0
- D. FastEthernet1/1

Answer: A

Question 8

R1 is unable to establish an OSPF neighbor relationship with R3. What are possible reasons for this problem? (Choose two)



- A. All of the routers need to be configured for backbone Area 1.
- B. R1 and R2 are the DR and BDR, so OSPF will not establish neighbor adjacency with R3.
- C. A static route has been configured from R1 to R3 and prevents the neighbor adjacency from being established.
- D. The hello and dead interval timers are not set to the same values on R1 and R3.

- E. EIGRP is also configured on these routers with a lower administrative distance.
- F. R1 and R3 are configured in different areas.

Answer: D F

Question 9

Refer to the exhibit. You have discovered that computers on the 192.168.10.0/24 network can ping their default gateway, but they cannot connect to any resources on a remote network. Which reason for the problem is most likely true?

```
R1
interface Loopback0
ip address 172.16.1.1 255.255.255.255
interface FastEthernet0/0
ip address 192.168.12.1 255.255.255.0
interface FastEthernet0/1
ip address 192.168.10.1 255.255.255.0
!
router ospf 1
router-id 172.16.1.1
network 172.16.1.1 0.0.0.0 area 0
network 192.168.10.0 0.0.0.255 area 0
```

- A. The 192.168.12.0/24 network is missing from OSPF.
- B. The OSPF process ID is incorrect.
- C. The OSPF area number is incorrect.
- D. An ARP table entry is missing for 192.168.10.0.
- E. A VLAN number is incorrect for 192.168.10.0.

Answer: A

Question 10

Which parameter or parameters are used to calculate OSPF cost in Cisco routers?

- A. Bandwidth, Delay and MTU
- B. Bandwidth
- C. Bandwidth and MTU
- D. Bandwidth, MTU, Reliability, Delay and Load

Answer: B

OSPF Questions 2

<http://www.9tut.com/ospf-questions-2>

Question 1

What routing protocol use first-hand information from peers?

- A. link state
- B. distance-vector
- C. path-vector
- D. other

Answer: A

Question 2

Which prefix does OSPFv3 use when multiple IPv6 address are configured on a single interface?

- A. all prefix on the interface
- B. the prefix that the administrator configure for OSPFv3 use
- C. the lowest prefix on the interface
- D. the highest prefix on the interface

Answer: A

Question 3

After you apply the given configuration to R1, you notice that it failed to enable OSPF. Which action can you take to correct the problem?

```
R1
ipv6 cef

interface FastEthernet0/0
no ip address
ipv6 enable
ipv6 address 2001:DB8:1::1/64
ipv6 ospf 1 area 0

ipv6 router ospf 1
router-id 172.16.1.1
```

- A. Configure a loopback interface on R1
- B. Enable IPv6 unicast routing on R1
- C. Configure an IPv4 address on interface Fa0/0
- D. Configure an autonomous system number on OSPF

Answer: B

Question 4

Refer to the exhibit. If R1 receives a packet destined to 172.16.1.1, to which IP address does it send the packet?

```
R1#show ip route
Codes: C - connected, S - static, R - RIP, M - mobile, B - BGP
       D - EIGRP, EX - EIGRP external, O - OSPF, IA - OSPF inter area
       N1 - OSPF NSSA external type 1, N2 - OSPF NSSA external type 2
       E1 - OSPF external type 1, E2 - OSPF external type 2
       i - IS-IS, su - IS-IS summary, L1 - IS-IS level-1, L2 - IS-IS level-2
       ia - IS-IS inter area, * - candidate default,
       o - ODR, P - periodic downloaded static route, H - NHRP, l - LISP

Gateway of last resort is 192.168.14.4 to network 0.0.0.0

C    192.168.12.0/24 is directly connected, FastEthernet0/0
C    192.168.13.0/24 is directly connected, FastEthernet0/1
C    192.168.14.0/24 is directly connected, FastEthernet1/0
     192.168.10.0/24 is variably subnetted, 3 subnets, 3 masks
O    192.168.10.0/24 [110/2] via 192.168.14.4, 00:02:00, FastEthernet1/0
O    192.168.10.32/27 [110/11] via 192.168.13.3, 00:00:51, FastEthernet0/1
O    192.168.0.0/16 [110/2] via 192.168.15.5, 00:02:00, FastEthernet1/1
D    192.168.10.1/32 [50/52778] via 192.168.12.2, 00:02:00, FastEthernet0/0
O*E2 0.0.0.0/0 [110/1] via 192.168.14.4, 01:35:54, FastEthernet1/0
```

- A. 192.168.14.4
- B. 192.168.12.2
- C. 192.168.13.3
- D. 192.168.15.5

Answer: A

Question 5

If two OSPF neighbors have formed complete adjacency and are exchanging link-state advertisements, which state have they reached?

- A. Exstart
- B. 2-Way
- C. FULL
- D. Exchange

Answer: C

Question 6

Which two steps must you perform on each device that is configured for IPv4 routing before you implement OSPFv3? (Choose two)

- A. Configure an autonomous system number
- B. Configure a loopback interface
- C. Configure a router ID
- D. Enable IPv6 on an interface
- E. Enable IPv6 unicast routing

Answer: C E

Question 7

Which command must you enter to enable OSPFv2 in an IPv4 network?

- A. ip ospf hello-interval seconds
- B. router ospfv2 process-id
- C. router ospf value
- D. router ospf process-id

Answer: D

Question 8

Why do large OSPF networks use a hierarchical design? (Choose three)

- A. to confine network instability to single areas of the network
- B. to reduce the complexity of router configuration
- C. to speed up convergence
- D. to lower costs by replacing routers with distribution layer switches
- E. to decrease latency by increasing bandwidth
- F. to reduce routing overhead

Answer: A C F

Question 9

Refer to the exhibit.

R1 ipv6 unicast-routing interface FastEthernet0/0 no ip address ipv6 enable ipv6 address 2001:DB8:12::1/64 ipv6 ospf 1 area 0 ipv6 router ospf 1 router-id 172.16.1.1	R2 ipv6 unicast-routing interface FastEthernet0/0 no ip address ipv6 enable ipv6 address 2001:DB8:12::2/64 ipv6 ospf 1 area 1 ipv6 router ospf 1 router-id 172.16.2.2
--	--

After you apply the give configurations to R1 and R2 you notice that OSPFv3 fails to start. Which reason for the problem is most likely true?

- A. The area numbers on R1 and R2 are mismatched
- B. The IPv6 network addresses on R1 and R2 are mismatched
- C. The autonomous system numbers on R1 and R2 are mismatched
- D. The router ids on R1 and R2 are mismatched

Answer: A

Question 10

When running OSPF, what would cause router A not to form an adjacency with router B?



- A. The loopback addresses are on different subnets.
- B. The values of the dead timers on the routers are different.
- C. Route summarization is enabled on both routers.
- D. The process identifier on router A is different than the process identifier on router

Answer: B

EIGRP Questions

<http://www.9tut.com/eigrp-questions>

Question 1

A network administrator is troubleshooting an EIGRP problem on a router and needs to confirm the IP addresses of the devices with which the router has established adjacency. The retransmit interval and the queue counts for the adjacent routers also need to be checked. What command will display the required information?

- A. Router# show ip eigrp neighbors
- B. Router# show ip eigrp interfaces
- C. Router# show ip eigrp adjacency
- D. Router# show ip eigrp topology

Answer: A

Question 2

Which option describes a difference between EIGRP for IPv4 and IPv6?

- A. Only EIGRP for IPv6 advertises all connected networks.
- B. Only EIGRP for IPv6 requires a router ID to be configured under the routing process
- C. AS numbers are configured in EIGRP but not in EIGRPv3.
- D. Only EIGRP for IPv6 is enabled in the global configuration mode.

Answer: B

Question 3

Which EIGRP for IPv6 command can you enter to view the link-local addresses of the neighbors of a device?

- A. show ipv6 eigrp 20 interfaces
- B. show ipv6 route eigrp
- C. show ipv6 eigrp neighbors
- D. show ip eigrp traffic

Answer: C

Question 4

Which function allows EIGRP peers to receive notice of implementing topology changes?

- A. successors
- B. advertised changes

- C. goodbye messages
- D. expiration of the hold timer

Answer: C

Question 5

What are the address that will show at the “show ip route” if we configure the above statements?
(Choose three)

```
router eigrp 100
network 172.15.4.0
network 10.4.3.0
network 192.168.4.0
auto-summary
```

- A. 10.0.0.0
- B. 10.4.3.0
- C. 172.15.4.0
- D. 172.15.0.0
- E. 192.168.4.0
- F. 192.168.0.0

Answer: A D E

Question 6

What does split horizon prevent?

- A. routing loops, link state
- B. routing loops, distance vector
- C. switching loops, STP
- D. switching loops, VTP

Answer: B

Question 7

What is called when variance with two times of metric?

- A. unequal cost load balancing
- B. path selection

- C. equal cost load balancing
- D. other

Answer: A

Question 8

Which feature is config by setting a variance that is at least 2 times the metric?

- A. unequal cost load balancing
- B. path selection
- C. equal cost load balancing
- D. path count

Answer: A

Question 9

Refer to the exhibit. Based on the exhibited routing table, how will packets from a host within the 192.168.10.192/26 LAN be forwarded to 192.168.10.1?

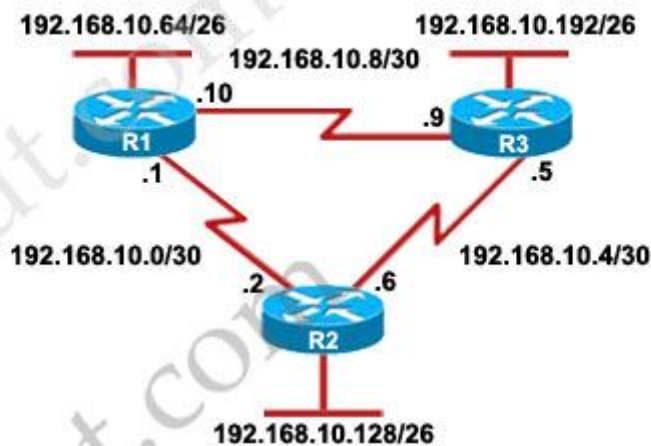

R3# show ip route

Gateway of last resort is not set

192.168.10.0/24 is variably subnetted, 6 subnets, 2 masks

- D 192.168.10.64/26 [90/2195456] via 192.168.10.9, 00:03:31, Serial0/0
- D 192.168.10.0/30 [90/2681856] via 192.168.10.9, 00:03:31, Serial0/0
- [90/2681856] via 192.168.10.5, 00:03:31, Serial0/1
- C 192.168.10.4/30 is directly connected, Serial0/1
- C 192.168.10.8/30 is directly connected, Serial0/0
- C 192.168.10.192/30 is directly connected, FastEthernet0/0
- C 192.168.10.128/26 [90/2195456] via 192.168.10.5, 00:03:31, Serial0/1

- A. The router will forward packets from R3 to R2 to R1
- B. The router will forward packets from R3 to R1
- C. The router will forward packets from R3 to R1 to R2
- D. The router will forward packets from R3 to R2 to R1 AND from R3 to R1

Answer: D

Question 10

Which two statements about EIGRP on IPv6 device are true? (Choose two)

- A. It is configured on the interface
- B. It is globally configured
- C. It is configured using a network statement
- D. It is vendor agnostic
- E. It supports a shutdown feature

Answer: A E

Question 11

If R1 is configured as shown, which three addresses will be received by other routers that are running EIGRP on the network? (Choose three)

```
R1(config)#router eigrp 103
R1(config-router)#network 10.4.3.0
R1(config-router)#network 172.16.4.0
R1(config-router)#network 192.168.2.0
R1(config-router)#auto-summary
```

- A. 172.16.4.0
- B. 10.0.0.0
- C. 172.16.0.0
- D. 192.168.2.0
- E. 192.168.0.0
- F. 10.4.3.0

Answer: B C D

Question 12

Which routing protocols are compatible with stubs? (Choose two)

- A. OSPF
- B. EIGRP
- C. EGP
- D. BGP
- E. IS-IS
- F. RIP

Answer: A B

BGP Questions

<http://www.9tut.com/bgp-questions>

Question 1

Which command can you enter to verify that a BGP connection to a remote device is established?

- A. show ip bgp summary
- B. show ip community-list
- C. show ip bgp paths
- D. show ip route

Answer: A

Question 2

Which two components are used to identify a neighbor in a BGP configuration? (Choose two)

- A. autonomous system number
- B. version number
- C. router ID
- D. subnet mask
- E. IP address

Answer: A E

Question 3

```
interface fa0/0
ip address 172.16.1.33 255.255.255.224
router bgp XXX
neighbor 10.1.5.2 remote as 65001
```

You need to advertise the network of int fa0/0. Which of the following would you type in the “network” command?

- A. 172.16.1.32 mask 255.255.255.224
- B. 172.16.1.32 255.255.255.224
- C. 172.16.1.32 mask 0.0.0.31
- D. 172.16.1.33 mask 255.255.255.224

Answer: A

Question 4

Which two statements about eBGP neighbor relationships are true? (Choose two)

- A. The two devices must reside in different autonomous systems
- B. Neighbors must be specifically declared in the configuration of each device
- C. They can be created dynamically after the network statement is configured.
- D. The two devices must reside in the same autonomous system
- E. The two devices must have matching timer settings

Answer: A B

IP SLA Questions

<http://www.9tut.com/ip-sla-questions>

Question 1

Which function of the IP SLAs ICMP jitter operation can you use to determine whether a VoIP issue is caused by excessive end-to-end time?

- A. round-trip time latency
- B. packet loss
- C. jitter
- D. successive packet loss

Answer: A

Question 2

Which statement about the IP SLAs ICMP Echo operation is true?

- A. The frequency of the operation specified in milliseconds.
- B. It is used to identify the best source interface from which to send traffic.
- C. It is configured in enable mode.
- D. It is used to determine the frequency of ICMP packets.

Answer: D

Question 3

What IP SLA ICMP Echo measures?

- A. Packet loss
- B. Congestion
- C. Hop-by-hop “something”
- D. End-to-end response time
- E. ?

Answer: D

Question 4

Which function does IP SLA ICMP ECHO operation perform to assist with troubleshooting?

- A. one way jitter measurement
- B. congestion detection
- C. hop-by-hop response time
- D. packet-loss detection

Answer: C

Question 5

Which feature or utility enables a switch or router to monitor network performance and availability using a responder?

- A. NetFlow
- B. ping
- C. traceroute
- D. IP SLA

Answer: D

NAT/PAT Questions

<http://www.9tut.com/natpat-questions>

Question 1

Which technology allows a large number of private IP addresses to be represented by a smaller number of public IP addresses?

- A. NAT
- B. NTP
- C. RFC 1631
- D. RFC 1918

Answer: A

Question 2

What is the effect of the overload keyword in a static NAT translation configuration?

- A. It enables port address translation.
- B. It enables the use of a secondary pool of IP addresses when the first pool is depleted.
- C. It enables the inside interface to receive traffic.
- D. It enables the outside interface to forward traffic.

Answer: A

Question 3

Which two types of NAT addresses are used in a Cisco NAT device? (Choose two)

- A. inside local
- B. inside global
- C. inside private
- D. outside private
- E. external global
- F. external local

Answer: A B

Question 4

What is the danger of the “permit any” entry in a NAT access list?

- A. It can lead to overloaded resources on the router.
- B. It can cause too many addresses to be assigned to the same interface.
- C. It can disable the overload command.
- D. It prevents the correct translation of IP addresses on the inside network.

Answer: A

Question 5

Which type of address is the public IP address of a NAT device?

- A. outside global
- B. outside local
- C. inside global
- D. inside local
- E. outside public
- F. inside public

Answer: C

Question 6

Which command can you enter to display the hits counter for NAT traffic?

- A. show ip nat statistics
- B. debug ip nat
- C. show ip debug nat
- D. clear ip nat statistics

Answer: A

Question 7

Which NAT function can map multiple inside addresses to a single outside address?

- A. PAT
- B. SFTP
- C. RARP
- D. ARP
- E. TFTP

Answer: A

Question 8

What is the first step in the NAT configuration process?

- A. Define inside and outside interfaces.
- B. Define public and private IP addresses.
- C. Define IP address pools.
- D. Define global and local interfaces.

Answer: A

Question 9

Under which circumstance should a network administrator implement one-way NAT?

- A. when the network must route UDP traffic
- B. when traffic that originates outside the network must be routed to internal hosts
- C. when traffic that originates inside the network must be routed to internal hosts
- D. when the network has few public IP addresses and many private IP addresses require outside access

Answer: B

Question 10

Which statement about the inside interface configuration in a NAT deployment is true?

- A. It is defined globally
- B. It identifies the location of source addresses for outgoing packets to be translated using access or route maps.
- C. It must be configured if static NAT is used
- D. It identifies the public IP address that traffic will use to reach the internet.

Answer: B

Question 11

Which NAT type is used to translate a single inside address to a single outside address?

- A. dynamic NAT
- B. NAT overload
- C. PAT
- D. static NAT

Answer: D

Question 12

What are two benefits of using NAT? (choose two)

- A. NAT protects network security because private networks are not advertised.
- B. NAT accelerates the routing process because no modifications are made on the packets.
- C. Dynamic NAT facilitates connections from the outside of the network.
- D. NAT facilitates end-to-end communication when IPsec is enable.
- E. NAT eliminates the need to re-address all host that require external access.
- F. NAT conserves addresses through host MAC-level multiplexing.

Answer: A E

Question 13

Which command can you enter to create a NAT pool of 6 addresses?

- A. Router(config)#ip nat pool test 175.17.12.69 175.17.12.74 prefix-length 24
- B. Router(config)#ip nat pool test 175.17.12.69 175.17.13.74 prefix-length 16
- C. Router(config)#ip nat pool test 175.17.12.66 175.17.12.72 prefix-length 8
- D. Router(config)#ip nat pool test 175.17.12.69 175.17.12.76 prefix-length 8

Answer: A

Question 14

How does NAT overloading provide one-to-many address translation?

- A. It uses a pool of addresses
- B. It converts IPV4 addresses to unused IPv6 Addresses
- C. It assigns a unique TCP/UDP port to each session
- D. It uses virtual MAC Address and Virtual IP Addresses

Answer: C

Question 15

What is the danger of the permit any entry in a NAT access list?

- A. It can lead to overloaded resources on the router.
- B. It can cause too many addresses to be assigned to the same interface.
- C. It can disable the overload command.
- D. It prevents the correct translation of IP addresses on the inside network.

Answer: A

Question 16

Which configuration can be used with PAT to allow multiple inside address to be translated to a single outside address?

- A. Dynamic Routing
- B. DNS
- C. Preempt
- D. Overload

Answer: D

HSRP Questions

<http://www.9tut.com/hsrp-questions>

Question 1

Which protocol advertises a virtual IP address to facilitate transparent failover of a Cisco routing device?

- A. FHRP
- B. DHCP
- C. RSMLT
- D. ESRP

Answer: A

Question 2

Which protocol is the Cisco proprietary implementation of FHRP?

- A. HSRP
- B. VRRP
- C. GLBP
- D. CARP

Answer: A (in fact GLBP is also correct)

Question 3

Which standards-based First Hop Redundancy Protocol is a Cisco supported alternative to Hot Standby Router Protocol?

- A. VRRP
- B. GLBP
- C. TFTP
- D. DHCP

Answer: A

Question 4

What are two requirements for an HSRP group? (Choose two)

- A. exactly one active router
- B. one or more standby routers
- C. one or more backup virtual routers
- D. exactly one standby active router
- E. exactly one backup virtual router

Answer: A B

Question 5

Which three options are the HSRP states for a router? (Choose three)

- A. initialize
- B. learn
- C. secondary
- D. listen
- E. speak
- F. primary

Answer: B D E

Question 6

Which standards-based First Hop Redundancy Protocol is a Cisco supported alternative to Hot Standby Router Protocol?

- A. VRRP
- B. GLBP
- C. TFTP
- D. DHCP

Answer: A

Question 7

Which value to use in HSRP protocol election process?

- A. interface
- B. virtual IP address
- C. priority
- D. router ID

Answer: C

Question 8

Which of the following is needed to be enable back the role of active in HSRP?

- A. preempt
- B. priority
- C. other options
- D. other options

Answer: A

Question 9

Which HSRP feature was new in HSRPv2?

- A. Group numbers that are greater than 255
- B. Virtual MAC addresses
- C. tracking
- D. preemption

Answer: A

Question 10

Which configuration command can you apply to a HSRP router so that its local interface becomes active if all other routers in the group fail?

- A. no additional config is required
- B. standby 1 track ethernet
- C. standby 1 preempt
- D. standby 1 priority 250

Answer: A

Question 11

Which three statements about HSRP operation are true? (Choose three)

- A. The virtual IP address and virtual MAC address are active on the HSRP Master router.
- B. The HSRP default timers are a 3 second hello interval and a 10 second dead interval.
- C. HSRP supports only clear-text authentication.
- D. The HSRP virtual IP address must be on a different subnet than the routers' interfaces on the same LAN.
- E. The HSRP virtual IP address must be the same as one of the router's interface addresses on the LAN.
- F. HSRP supports up to 255 groups per interface, enabling an administrative form of load balancing.

Answer: A B F

Question 12

What is a valid HSRP virtual MAC address?

- A. 0000.5E00.01A3
- B. 0007.B400.AE01
- C. 0000.0C07.AC15
- D. 0007.5E00.B301

Answer: C

IPv6 Questions

<http://www.9tut.com/ipv6-questions>

Question 1

In which two formats can the IPv6 address fd15:0db8:0000:0000:0700:0003:400F:572B be written?
(Choose two)

- A. fd15:0db8:0000:0000:700:3:400F:527B
- B. fd15:0db8::7:3:4F:527B
- C. fd15::db8::700:3:400F:527B
- D. fd15:db8::700:3:400F:572B
- E. fd15:db8:0::700:3:4F:527B

Answer: A D

Question 2

Which statements about IPv6 prefixes are true?

- A. FEC0::/10 is used for IPv6 broadcast.
- B. FC00::/7 is used in private networks.
- C. FE80::/8 is used for link-local unicast.
- D. FE80::/10 is used for link-local unicast
- E. 2001::1/127 is used for loopback addresses.
- F. FF00::/8 is used for IPv6 multicast.

Answer: B D F

Question 3

Which statements about IPv6 and routing protocols are true? (Choose two)

- A. EIGRPv3 was developed to support IPv6 routing.
- B. OSPFv3 was developed to support IPv6 routing.
- C. Loopback addresses are used to form routing adjacencies.
- D. EIGRP, OSPF, and BGP are the only routing protocols that support IPv6.
- E. Link-local addresses are used to form routing adjacencies.

Answer: B E

Question 4

Which command can you enter to verify that a 128-bit address is live and responding?

- A. traceroute
- B. telnet
- C. ping
- D. ping ipv6

Answer: D

Question 5

Which technology supports the stateless assignment of IPv6 addresses?

- A. DNS
- B. DHCPv6
- C. DHCP
- D. autoconfiguration

Answer: B

Question 6

Which IPv6 header field is equivalent to the TTL?

- A. Hop Limit
- B. Flow Label
- C. TTD
- D. Hop Count
- E. Scan Timer

Answer: A

Question 7

Which two statements about the “tunnel mode ipv6ip” command are true? (Choose two)

- A. It enables the transmission of IPv6 packets within the configured tunnel.
- B. It specifies IPv4 as the encapsulation protocol.
- C. It specifies IPv6 as the encapsulation protocol.
- D. It specifies IPv6 as the transport protocol.
- E. It specifies that the tunnel is a Teredo tunnel.

Answer: A B

Question 8

In which three ways is an IPv6 header simpler than an IPv4 header? (Choose three)

- A. Unlike IPv4 headers, IPv6 headers have a fixed length.
- B. IPv6 uses an extension header instead of the IPv4 Fragmentation field.
- C. IPv6 headers eliminate the IPv4 Checksum field.
- D. IPv6 headers use the Fragment Offset field in place of the IPv4 Fragmentation field.
- E. IPv6 headers use a smaller Option field size than IPv4 headers.
- F. IPv6 headers use a 4-bit TTL field, and IPv4 headers use an 8-bit TTL field.

Answer: A B C

Question 9

Which two features can dynamically assign IPv6 addresses? (Choose two)

- A. IPv6 stateless autoconfiguration
- B. DHCP
- C. NHRP
- D. IPv6 stateful autoconfiguration
- E. ISATAP tunneling

Answer: A D

IPv6 Questions 2

<http://www.9tut.com/ipv6-questions-2>

Question 1

Which two statements about IPv6 router advertisement messages are true? (Choose two)

- A. They use ICMPv6 type 134.
- B. The advertised prefix length must be 64 bits.
- C. The advertised prefix length must be 48 bits.
- D. They are sourced from the configured IPv6 interface address.
- E. Their destination is always the link-local address of the neighboring node.

Answer: A B

Question 2

Which three statements about IPv6 prefixes are true? (Choose three)

- A. FF00::8 is used for IPv6 multicast.
- B. FE80::/10 is used for link-local unicast.

- C. FC00::/7 is used in private networks.
- D. 2001::1/127 is used for loopback addresses.
- E. FE80::/8 is used for link-local unicast.
- F. FEC0::/10 is used for IPv6 broadcast.

Answer: A B C

Question 3

You enter the “show ipv6 route” command on an OSPF device and the device displays a route. Which conclusion can you draw about the environment?

- A. OSPF is distributing IPv6 routes to BGP.
- B. The router is designated as an ABR.
- C. The router is designated as totally stubby.
- D. OSPFv3 is in use.

Answer: D

Question 4

What is one requirement for interfaces to run IPv6?

- A. An IPv6 address must be configured on the interface.
- B. An IPv4 address must be configured.
- C. Stateless autoconfiguration must be enabled after enabling IPv6 on the interface.
- D. IPv6 must be enabled with the ipv6 enable command in global configuration mode.

Answer: A

Question 5

Which entity assigns IPv6 addresses to end users?

- A. ICANN
- B. APNIC
- C. RIR
- D. ISPs

Answer: D

Question 6

Which command enables IPv6 forwarding on a cisco router?

- A. IPv6 host
- B. IPv6 unicast-routing
- C. IPv6 local
- D. IPv6 neighbor

Answer: B

Question 7

What is the correct command for floating static ipv6 route?

- A. ipv6 route 2001:DB8::/32 serial 2/0 201
- B. ipv6 route 2001:DB8::/32 serial 2/0 1
- C. ?
- D. ?

Answer: A

Question 8

What are types of IPv6 static routes? (Choose three)

- A. Recursive routes
- B. Directly connected routes
- C. Fully specified routes
- D. Advertised routes
- E. Virtual links
- F. Redistributed routes

Answer: A B C

Question 9

What are three parts of an IPv6 global unicast address? (Choose three)

- A. an interface ID that is used to identify the local host on the network.
- B. an interface ID that is used to identify the local network for a particular host.
- C. a subnet ID that is used to identify networks inside of the local enterprise site
- D. a global routing prefix that is used to identify the network portion of the address that has been provided by an ISP
- E. a global routing prefix that is used to identify the portion of the network address provided by a local administrator

Answer: A C D

Question 10

Which two statements about unique local IPv6 addresses are true? (Choose two)

- A. They are identical to IPv4 private addresses.
- B. They are defined by RFC 1884
- C. They use the prefix FEC0::/10
- D. They use the prefix FC00::/7
- E. They can be routed on the IPv6 global internet.

Answer: A D

IPv6 Questions 3

<http://www.9tut.com/ipv6-questions-3>

Question 1

What is the binary pattern of unique IPv6 unique local address?

- A. 00000000
- B. 11111100
- C. 11111111
- D. 11111101

Answer: B

Question 2

Which IPv6 function serves the same purpose as ARP entry verification on an IPv4 network?

- A. interface ip address verification
- B. MAC address table verification
- C. neighbor discovery verification
- D. Routing table entry verification

Answer: C

Question 3

Which type of ipv6 unicast IP address is reachable across the Internet?

- A. Unique Local
- B. Compatible
- C. Link local
- D. Global

Answer: D

Question 4

Which header field is new on IPv6?

- A. Version
- B. Hop Limit
- C. Flow Label
- D. Traffic Class

Answer: C

Question 5

Which type of IP address of IPv6 that also exist in IPv4 but barely used?

- A. unicast
- B. multicast
- C. anycast
- D. broadcast

Answer: C

Question 6

What is known as one-to-nearest addressing in IPv6?

- A. global unicast
- B. anycast
- C. multicast
- D. unspecified address

Answer: B

Question 7

Which command can you enter to configure an IPv6 floating static route?

- A. Router(config)# ipv6 route static resolve default
- B. Router(config)# ipv6 route ::/0 serial0/1
- C. Router(config)# ipv6 route FE80:0202::/32 serial 0/1 201
- D. Router(config)# ipv6 route FE80:0202::/32 serial 0/1 1

Answer: C

Question 8

How many bit represents the network ID in IPv6?

- A. 32
- B. 48
- C. 64
- D. 128

Answer: C

Question 9

Which statement about IPv6 link-local addresses is true?

- A. They must be configured on all IPv6 interface
- B. They must be globally unique
- C. They must be manually configured
- D. They are advertised globally on the network

Answer: A

Question 10

Which tunneling mechanism embeds an IPv4 address within an IPv6 address?

- A. Teredo
- B. 6to4
- C. 4to6
- D. GRE
- E. ISATAP

Answer: B

IPv6 Questions 4

<http://www.9tut.com/ipv6-questions-4>

Question 1

Which two statements about IPv6 address fd14:920b:f83d:4079::/64 are true? (Choose two)

- A. The subnet ID is 14920bf83d
- B. The subnet ID is 4079
- C. The global ID is 14920bf83d
- D. The address is a link-local address
- E. The global ID is 4079
- F. The address is a unique local address

Answer: B F

Question 2

Which IPv6 routing protocol uses multicast group FF02::9 to send updates?

- A. static
- B. RIPng
- C. OSPFv3
- D. IS-IS for IPv6

Answer: B

Question 3

Which two statements about IPv6 address 2002:ab10:beef::/48 are true? (Choose two)

- A. The embedded IPv4 address can be globally routed
- B. It is used for an ISATAP tunnel
- C. The embedded IPv4 address is an RFC 1918 address
- D. The MAC address 20:02:b0:10:be:ef is embedded into the IPv6 address
- E. It is used for a 6to4 tunnel

Answer: A E

Question 4

What is the most efficient subnet mask for a point to point IPv6 connection?

- A. /127
- B. /128
- C. /64
- D. /48
- E. /32

Answer: A

Question 5

Which protocol does IPv6 use to discover other IPv6 nodes on the same segment?

- A. CLNS
- B. TCPv6
- C. NHRP
- D. NDP
- E. ARP

Answer: D

Question 6

Which address block identifies all link-local addresses?

- A. FC00::/7
- B. FC00::/8
- C. FE80::/10
- D. FF00::/8

Answer: C

Question 7

What are three features of the IPv6 protocol? (Choose three)

- A. complicated header
- B. plug-and-play
- C. no broadcasts
- D. checksums
- E. optional IPsec
- F. autoconfiguration

Answer: B C F

Question 8

Which two statements describe characteristics of IPv6 unicast addressing? (Choose two)

- A. Global addresses start with 2000::/3
- B. Link-local addresses start with FE00::/12
- C. Link-local addresses start with FF00::/10
- D. There is only one loopback address and it is ::1
- E. If a global address is assigned to an interface, then that is the only allowable address for the interface.

Answer: A D

Security Questions

<http://www.9tut.com/security-questions>

Question 1

Which statement about RADIUS security is true?

- A. It supports EAP authentication for connecting to wireless networks.
- B. It provides encrypted multiprotocol support.
- C. Device-administration packets are encrypted in their entirety.
- D. It ensures that user activity is fully anonymous.

Answer: A

Question 2

Which condition indicates that service password-encryption is enabled?

- A. The local username password is in clear text in the configuration.
- B. The enable secret is in clear text in the configuration.
- C. The local username password is encrypted in the configuration.
- D. The enable secret is encrypted in the configuration.

Answer: C

Question 3

Which command can you enter to configure a local username with an encrypted password and EXEC mode user privileges?

- A. Router(config)#username jdone privilege 1 password 7 08314D5D1A48
- B. Router(config)#username jdone privilege 1 password 7 PASSWORD1
- C. Router(config)#username jdone privilege 15 password 0 08314D5D1A48
- D. Router(config)#username jdone privilege 15 password 0 PASSWORD1

Answer: A

Question 4

Which command sets and automatically encrypts the privileged enable mode password?

- A. enable password c1sco
- B. secret enable c1sco
- C. password enable c1sco
- D. enable secret c1sco

Answer: D

Question 5

The enable secret command is used to secure access to which CLI mode?

- A. user EXEC mode
- B. global configuration mode
- C. privileged EXEC mode
- D. auxiliary setup mode

Answer: C

Question 6

Refer to the exhibit. What is the result of setting the no login command?

```
Router#config t
Router(config)#line vty 0 4
Router(config-line)#password c1sc0
```

Router(config-line)#no login

- A. Telnet access is denied.
- B. Telnet access requires a new password at the first login.
- C. Telnet access requires a new password.
- D. no password is required for telnet access.

Answer: D

Question 7

What is a difference between TACACS+ and RADIUS in AAA?

- A. Only TACACS+ allows for separate authentication.
- B. Only RADIUS encrypts the entire access-request packet.
- C. Only RADIUS uses TCP.
- D. Only TACACS+ couples authentication and authorization.

Answer: A

Question 8

Which protocol authenticates connected devices before allowing them to access the LAN?

- A. 802.1d
- B. 802.11
- C. 802.1w
- D. 802.1x

Answer: D

Question 9

Which three options are benefits of using TACACS+ on a device? (Choose three)

- A. It ensures that user activity is untraceable.
- B. It provides a secure accounting facility on the device.
- C. device-administration packets are encrypted in their entirety.
- D. It allows the user to remotely access devices from other vendors.
- E. It allows the users to be authenticated against a remote server.
- F. It supports access-level authorization for commands.

Answer: C E F

Question 10

A security administrator wants to profile endpoints and gain visibility into attempted authentications. Which 802.1x mode allows these actions?

- A. Monitor mode
- B. High-Security mode
- C. Low-impact mode
- D. Closed mode

Answer: A

Question 11

What should be part of a comprehensive network security plan?

- A. Allow users to develop their own approach to network security
- B. Physically secure network equipment from potential access by unauthorized individuals
- C. Encourage users to use personal information in their passwords to minimize the likelihood of passwords being forgotten
- D. Delay deployment of software patches and updates until their effect on end-user equipment is well known and widely reported
- E. Minimize network overhead by deactivating automatic antivirus client updates

Answer: B

Question 12

Which password types are encrypted?

- A. SSH
- B. Telnet
- C. enable secret
- D. enable password

Answer: C

Security Questions 2

<http://www.9tut.com/security-questions-2>

Question 1

How do you maintain security in multiple websites?

- A. VPN
- B. DMVPN
- C. other
- D. other

Answer: A

Question 2

Which of the following encrypts the traffic on a leased line?

- A. telnet
- B. ssh
- C. vtp
- D. vpn
- E. dmvpn

Answer: B

Question 3

Which command is necessary to permit SSH or Telnet access to a Cisco switch that is otherwise configured for these vty line protocols?

- A. transport type all
- B. transport output all
- C. transport preferred all
- D. transport input all

Answer: D

Question 4

How to verify SSH connections were secured?

- A. ssh -v 1 -l admin IP
- B. ssh -v 2 -l admin IP

- C. ssh -l admin IP
- D. ssh -v 2 admin IP

Answer: B

Question 5

In order to comply with new auditing standards, a security administrator must be able to correlate system security alert logs directly with the employee who triggers the alert. Which of the following should the security administrator implement in order to meet this requirement?

- A. Access control lists on file servers
- B. Elimination of shared accounts
- C. Group-based privileges for accounts
- D. Periodic user account access reviews

Answer: D

Question 6

Which three feature are represented by A letter in AAA? (Choose three)

- A. authorization
- B. accounting
- C. authentication
- D. accountability
- E. accessibility
- F. authority

Answer: A B C

Question 7

What are two statements for SSH?

- A. use port 22
- B. unsecured
- C. encrypted
- D. most common remote-access method
- E. operate at transport

Answer: A C

Question 8

Which two statements about TACACS+ are true? (Choose two)

- A. It can run on a UNIX server.
- B. It authenticates against the user database on the local device.
- C. It is more secure than AAA authentication.
- D. It is enabled on Cisco routers by default.
- E. It uses a managed database.

Answer: A E

Question 9

Refer to the exhibit. Which user-mode password has just been set?

```
R1#config
R1(config)#line vty 0 4
R1(config-line)#password C1scO
R1(config-line)#login
```

- A. Telnet
- B. Auxiliary
- C. SSH
- D. Console

Answer: A

Question 10

Which two passwords must be supplied in order to connect by Telnet to a properly secured Cisco switch and make changes to the device configuration? (Choose two)

- A. tty password
- B. enable secret password
- C. vty password
- D. aux password
- E. console password
- F. username password

Answer: B C

Question 11

Which two statements about firewalls are true?

- A. They can be used with an intrusion prevention system.
- B. They can limit unauthorized user access to protect data.
- C. Each wireless access point requires its own firewall
- D. They must be placed only at locations where the private network connects to the internet.
- E. They can prevent attacks from the internet only.

Answer: A B

Question 12

Which three options are types of Layer 2 network attack? (Choose three)

- A. Spoofing attacks
- B. VLAN Hopping
- C. Botnet attacks
- D. DDOS attacks
- E. ARP Attacks
- F. Brute force attacks

Answer: A B E

Question 13

Which IEEE mechanism is responsible for the authentication of devices when they attempt to connect to a local network?

- A. 802.1x
- B. 802.11
- C. 802.2x
- D. 802.3x

Answer: A

Question 14

Which IPsec security protocol should be used when confidentiality is required?

- A. AH
- B. MD5
- C. PSK
- D. ESP

Answer: D

Troubleshooting Questions

<http://www.9tut.com/troubleshooting-questions>

Question 1

Which interface counter can you use to diagnose a duplex mismatch problem?

- A. runts
- B. CRC errors
- C. no carrier
- D. late collisions
- E. deferred
- F. giants

Answer: D

Question 2

Refer to the exhibit. The two connected ports on the switch are not turning orange or green. What would be the most effective steps to troubleshoot this physical layer problem? (Choose three)

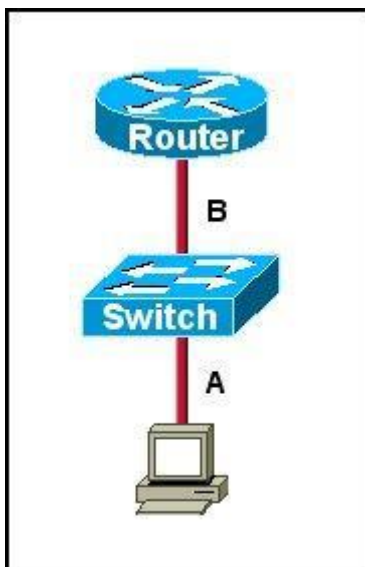

- A. Ensure that the Ethernet encapsulations match on the interconnected router and switch ports.
- B. Ensure that cables A and B are straight-through cables.
- C. Ensure cable A is plugged into a trunk port.
- D. Ensure the switch has power.

- E. Reboot all of the devices.
- F. Reseat all cables.

Answer: B D F

Question 3

What are reasons that duplex mismatches can be difficult to diagnose? (Choose two)

- A. The interface displays a connected (up/up) state even when the duplex settings are mismatched.
- B. 1-Gbps interfaces are full-duplex by default.
- C. Full-duplex interfaces use CSMA/CD logic, so mismatches may be disguised by collisions.
- D. The symptoms of a duplex mismatch may be intermittent.
- E. Autonegotiation is disabled.

Answer: A D

Question 4

What are two reasons that duplex mismatches can be difficult to diagnose? (Choose two)

- A. The interface displays a connected (up/up) state even when the duplex settings are mismatched.
- B. The symptoms of a duplex mismatch may be intermittent.
- C. Autonegotiation is disabled.
- D. Full-duplex interfaces use CSMA/CD logic, so mismatches may be disguised by collisions.
- E. 1-Gbps interfaces are full-duplex by default.

Answer: A B

Question 5

What is the best way to verify that a host has a path to other hosts in different networks?

- A. Ping the loopback address.
- B. Ping the default gateway.
- C. Ping the local interface address.
- D. Ping the remote network.

Answer: D

Question 6

While you were troubleshooting a connection issue, a ping from one VLAN to another VLAN on the same switch failed. Which command verifies that IP routing is enabled on interfaces and the local VLANs are up?

- A. show ip interface brief
- B. show ip nat statistics
- C. show ip statistics
- D. show ip route

Answer: A

Question 7

Describe the best way to troubleshoot and isolate a network problem?

- A. Create an action plan
- B. Implement an action plan
- C. Gather facts
- D. Change one variable at a time

Answer: C

Question 8

Refer to exhibit. Which command can you enter to verify link speed and duplex setting on the interface?

```
R1(config)#interface gigabitEthernet0/1
R1(config-if)#ip address 192.168.1.1. 255.255.255.0
R1(config-if)#speed 100
R1(config-if)#duplex full
```

- A. router#show ip protocols
- B. router#show startup-config
- C. router#show line
- D. router#show interface gig 0/1

Answer: D

Question 9

When you troubleshoot an IPv4 connectivity issue on a router, which three router configuration checks you must perform?

- A. Verify that the router interface IP address is correct.
- B. Verify that the DNS is configured correctly.
- C. Verify that the router and the host use the same subnet mask.
- D. Verify that the router firmware is up-to-date.
- E. Verify that a default route is configured.
- F. Verify that the route appears in the Routing table

Answer: A C F

Question 10

Which command can be used from a PC to verify the connectivity between hosts that connect through a switch in the same LAN?

- A. tracert address
- B. ping address
- C. arp address
- D. traceroute address

Answer: B

Question 11

When troubleshooting client DNS issues, which two tasks must you perform? (Choose two)

- A. Ping a public website IP address.
- B. Ping the DNS Server.
- C. Determine whether a DHCP address has been assigned.
- D. Determine whether the hardware address is correct.
- E. Determine whether the name servers have been configured

Answer: B E

Question 12

Which two statements about extended traceroute command is true?

- A. It can send packets from specified interface or IP address
- B. It can use a specified TTL value
- C. It can validate the reply data

- D. It can use a specified TOS
- E. It can repeated automatically to a specified interval

Answer: A B

Question 13

Which symptom most commonly indicates that two connecting interface are configured with a duplex mismatch?

- A. an interface with up/down state
- B. an interface with down/down state
- C. late collisions on the interface
- D. the spanning tree process shutting down

Answer: C

Question 14

When is the most appropriate time to escalate an issue that you troubleshooting?

- A. When you lack the proper to resolve the issue
- B. When a more urgent issue that requires your intervention is detected
- C. When you have gathered all information about an issue
- D. When you have been unable to resolve the issue after 30 min

Answer: A

DHCP Questions

<http://www.9tut.com/dhcp-questions>

Question 1

Which command can you enter to display duplicate IP addresses that the DHCP server assigns?

- A. show ip dhcp conflict 10.0.2.12
- B. show ip dhcp database 10.0.2.12
- C. show ip dhcp server statistics
- D. show ip dhcp binding 10.0.2.12

Answer: A

Question 2

What is the default lease time for a DHCP binding?

- A. 24 hours
- B. 12 hours
- C. 48 hours
- D. 36 hours

Answer: A

Question 3

Which statement is correct regarding the operation of DHCP?

- A. A DHCP client uses a ping to detect address conflicts.
- B. A DHCP server uses a gratuitous ARP to detect DHCP clients.
- C. A DHCP client uses a gratuitous ARP to detect a DHCP server.
- D. If an address conflict is detected, the address is removed from the pool and an administrator must resolve the conflict.
- E. If an address conflict is detected, the address is removed from the pool for an amount of time configurable by the administrator.
- F. If an address conflict is detected, the address is removed from the pool and will not be reused until the server is rebooted.

Answer: D

Question 4

Which command is used to build DHCP pool?

- A. ip dhcp pool DHCP
- B. ip dhcp conflict
- C. ip dhcp-server pool DHCP
- D. ip dhcp-client pool DHCP

Answer: A

Question 5

What is the two benefits of DHCP snooping? (Choose two)

- A. static reservation
- B. DHCP reservation
- C. prevent DHCP rouge server
- D. prevent untrusted host and servers to connect

Answer: C D

Question 6

What command can you enter in config mode to create DHCP pool?

- A. ip dhcp pool DHCP_pool
- B. ip dhcp exclude -add
- C. ip dhcp conflict logging
- D. service dhcp

Answer: A

Question 7

Where information about untrusted hosts are stored?

- A. CAM table
- B. Trunk table
- C. MAC table
- D. binding database

Answer: D

Question 8

Which command can you enter to determine the addresses that have been assigned on a DHCP Server?

- A. show ip dhcp database
- B. show ip dhcp pool
- C. show ip dhcp binding
- D. show ip dhcp server statistic

Answer: C

Question 9

Which command can you enter to troubleshoot the failure of address assignment?

- A. show ip dhcp database
- B. show ip dhcp pool
- C. show ip dhcp import
- D. show ip dhcp server statistics

Answer: B

Question 10

Requirement to configure DHCP binding (Choose two)

- A. DHCP pool
- B. IP address
- C. Hardware address
- D. other option

Answer: B C

DHCP Questions 2

<http://www.9tut.com/dhcp-questions-2>

Question 1

How to see DHCP conflict?

- A. show ip dhcp pool
- B. show dhcp database
- C. show ip dhcp conflict

Answer: C

Question 2

Where does the configuration reside when a helper address is configured to support DHCP?

- A. on the switch trunk interface.
- B. on the router closest to the client.
- C. on the router closest to the server.
- D. on every router along the path.

Answer: B

Question 3

How does a DHCP server dynamically assign IP addresses to hosts?

- A. Addresses are permanently assigned so that the host uses the same address at all times.
- B. Addresses are assigned for a fixed period of time.
- C. Addresses are leased to hosts. A host will usually keep the same address by periodically contacting the DHCP server to renew the lease.
- D. Addresses are allocated after a negotiation between the server and the host to determine the length of the agreement.

Answer: C

Question 4

Which statement about DHCP snooping is true?

- A. It blocks traffic from DHCP servers on untrusted interfaces.
- B. It can be configured on switches and routers.
- C. It allows packets from untrusted ports if their source MAC address is found in the binding table.
- D. It uses DHCPDiscover packets to identify DHCP servers.

Answer: A

Question 5

Refer to the exhibit.

```
ip dhcp pool test
  network 192.168.10.0/27
  domain name cisco.com
  dns-server 172.16.1.1 172.16.2.1
  netbios-name-server 172.16.1.10 172.16.2.10
```

After you apply the given configuration to a router, the DHCP clients behind the device cannot communicate with hosts outside of their subnet. Which action is most likely to correct the problem?

- A. Configure the DNS server on the same subnet as the clients
- B. Activate the dhcp pool
- C. Correct the subnet mask
- D. Configure the default gateway

Answer: D

Question 6

Where does a switch maintain DHCP snooping information?

- A. in the CAM table
- B. in the VLAN database
- C. in the DHCP binding database
- D. in the MAC address table

Answer: C

Question 7

While troubleshooting a DHCP client that is behaving erratically, you discover that the client has been assigned the same IP address as a printer that is a static IP address. Which option is the best way to resolve the problem?

- A. Configure a static route to the client
- B. Assign the client the same IP address as the router
- C. Move the client to another IP subnet
- D. Move the printer to another IP subnet
- E. Reserve the printer IP address

Answer: E

Syslog Questions

<http://www.9tut.com/syslog-questions>

Question 1

Which logging command can enable administrators to correlate syslog messages with millisecond precision?

- A. logging buffered 4
- B. logging host 10.2.0.21
- C. logging console
- D. service timestamps log datetime msec
- E. logging monitor

Answer: D

Question 2

If you configure syslog messages without specifying the logging trap level, which log messages will the router send?

- A. informational messages only
- B. warning and error conditions only
- C. normal but significant conditions only
- D. error conditions only
- E. all levels except debugging

Answer: E

Question 3

If you are configuring syslog messages specifying 'logging trap warning', which log messages will the router send?

- A. 0-4
- B. 0-5
- C. 0-2
- D. 0-6
- E. 0-1

Answer: A

Question 4

If you configure syslog messages without specifying the logging trap level, which log messages will the router send?

- A. 0-4
- B. 0-5
- C. 0-2
- D. 0-6
- E. 0-1

Answer: D

Question 5

Two statements about syslog logging?

- A. Syslog logging is disabled by default
- B. Messages are stored in the internal memory of device
- C. Messages can be erased when device reboots
- D. Messages are stored external to the device
- E. ?
- F. ?

Answer: B C

Question 6

Refer to the exhibit. What is the cause of the Syslog output messages?

```
*Mar 01, 00:40:10.3111: %SYS-5-CONFIG_I: Configured from console by console
%LINK-5-CHANGED: Interface FastEthernet0/1, changed state to administratively down
%LINEPROTO-5-UPDOWN: Line protocol on Interface FastEthernet0/1, changed state to down
%DUAL-5-NBRCHANGE: IP-EIGRP 1: Neighbor 10.10.11.2 (FastEthernet0/1) is down: interface down
```

- A. The EIGRP neighbor on Fa0/1 went down due to a failed link.
- B. The EIGRP neighbor connected to Fa0/1 is participating in a different EIGRP process, causing the adjacency to go down.
- C. A shut command was executed on interface Fa0/1, causing the EIGRP adjacency to go down.
- D. Interface Fa0/1 has become error disabled, causing the EIGRP adjacency to go down.

Answer: C

Question 7

What command instructs the device to timestamp Syslog debug messages in milliseconds?

- A. service timestamps log datetime localtime
- B. service timestamps debug datetime msec
- C. service timestamps debug datetime localtime
- D. service timestamps log datetime msec

Answer: B

SNMP Questions

<http://www.9tut.com/snmp-questions>

Question 1

Which version of SNMP first allowed user-based access?

- A. SNMPv3 with RBAC
- B. SNMPv3
- C. SNMPv1
- D. SNMPv2

Answer: B

Question 2

What is the first step you perform to configure an SNMPv3 user?

- A. Configure server traps.
- B. Configure the server group.
- C. Configure the server host.
- D. Configure the remote engine ID.

Answer: B

Question 3

Which statement about SNMPv2 is true?

- A. Its privacy algorithms use MD5 encryption by default.
- B. It requires passwords to be encrypted.
- C. Its authentication and privacy algorithms are enabled without default values.
- D. It requires passwords at least eight characters in length.

Answer: C

Question 4

Which command can you enter on a switch to determine the current SNMP security model?

- A. snmp-server contact
- B. show snmp pending
- C. show snmp group
- D. show snmp engineID

Answer: C

Question 5

Which command do we use to see SNMP version?

- A. show snmp pending
- B. show snmp engineID
- C. snmp-server manager

Answer: A

Question 6

Which three statements about the features of SNMPv2 and SNMPv3 are true? (Choose three)

- A. SNMPv3 enhanced SNMPv2 security features
- B. SNMPv3 added the Inform protocol message to SNMP
- C. SNMPv2 added the Inform protocol message to SNMP
- D. SNMPv3 added the GetBulk protocol messages to SNMP
- E. SNMPv2 added the GetBulk protocol message to SNMP
- F. SNMPv2 added the GetNext protocol message to SNMP

Answer: A C E

Question 7

Which feature can you use to restrict SNMP queries to a specific OID tree?

- A. server group
- B. a community
- C. a view record
- D. an access group

Answer: C

NTP Questions

<http://www.9tut.com/ntp-questions>

Question 1

Which NTP command configures the local device as an NTP reference clock source?

- A. ntp peer
- B. ntp broadcast
- C. ntp master
- D. ntp server

Answer: C

Question 2

What command is used to configure a switch as authoritative NTP server?

- A. ntp master 3
- B. ntp peer IP
- C. ntp server IP
- D. ntp source IP

Answer: A

Question 3

Which value indicates the distance from the NTP authoritative time source?

- A. priority
- B. location
- C. layer
- D. stratum

Answer: D

Question 4

Which NTP type designates a router without an external reference clock as an authoritative time source?

- A. server
- B. peer
- C. master
- D. client

Answer: C

Question 5

Which command can you enter to configure the switch as an authoritative NTP server with a site id: 13999902?

- A. Switch(config)#ntp master 3
- B. Switch(config)#ntp peer 193.168.2.2
- C. Switch(config)#ntp server 193.168.2.2
- D. Switch(config)#ntp source 193.168.2.2

Answer: A

Question 6

Which two command can you enter to display the current time sources statistics on devices? (Choose two)

- A. show ntp associations
- B. show clock details
- C. show clock
- D. show how time
- E. show ntp status

Answer: A E

Question 7

Which three commands are required to enable NTP authentication on a Cisco router? (Choose three)

- A. ntp peer
- B. ntp max-associations
- C. ntp authenticate
- D. ntp trusted-key
- E. ntp authentication-key
- F. ntp refclock

Answer: C D E

SDN Solution

<http://www.9tut.com/sdn-solution>

Question 1

Which component of the Cisco SDN solution serves as the centralized management system?

- A. Cisco OpenDaylight
- B. Cisco ACI
- C. Cisco APIC
- D. Cisco IWAN

Answer: C

Question 2

Which two statements about northbound and southbound APIs are true? (Choose two)

- A. Only southbound APIs allow program control of the network.
- B. Only northbound APIs allow program control of the network.
- C. Only southbound API interfaces use a Service Abstraction Layer.
- D. Only northbound API interfaces use a Service Abstraction Layer.
- E. Both northbound and southbound API interfaces use a Service Abstraction Layer.
- F. Both northbound and southbound APIs allow program control of the network.

Answer: B C

Question 3

Which two options are primary responsibilities of the APIC-EM controller? (Choose two.)

- A. It automates network actions between different device types.
- B. It provides robust asset management.
- C. It tracks license usage and Cisco IOS versions.
- D. It automates network actions between legacy equipment.
- E. It makes network functions programmable.

Answer: A E

Question 4

Which utility can you use to identify redundant or shadow rules?

- A. The ACL trace tool in Cisco APIC-EM.
- B. The ACL analysis tool in Cisco APIC-EM.
- C. The Cisco APIC-EM automation scheduler.
- D. The Cisco IWAN application.

Answer: B

Question 5

Which utility can you use to identify the cause of a traffic-flow blockage between the two devices in a network?

- A. ACL path analysis tool in APIC-EM
- B. iWAN application
- C. ACL analysis tool in APIC-EM
- D. APIC-EM automation scheduler

Answer: A

Wireless Questions

<http://www.9tut.com/wireless-questions>

Question 1

Which device allows users to connect to the network using a single or double radio?

- A. access point
- B. switch
- C. wireless controller
- D. firewall

Answer: A

Question 2

Which two statements about wireless LAN controllers are true? (Choose two)

- A. They can simplify the management and deployment of wireless LANs.
- B. They rely on external firewalls for WLAN security.
- C. They are best suited to smaller wireless networks.
- D. They must be configured through a GUI over HTTP or HTTPS.
- E. They can manage mobility policies at a systemwide level.

Answer: A E

Question 3

Which WAN topology is most appropriate for a centrally located server farm with several satellite branches?

- A. star
- B. hub and spoke
- C. point-to-point
- D. full mesh

Answer: B

Question 4

What are three broadband wireless technologies? (Choose three)

- A. WiMax
- B. satellite Internet
- C. municipal Wi-Fi
- D. site-to-site VPN
- E. DSLAM
- F. CMTS

Answer: A B C

Question 5

What are three characteristics of satellite Internet connections? (Choose three)

- A. Their upload speed is about 10 percent of their download speed.
- B. They are frequently used by rural users without access to other high-speed connections.
- C. They are usually at least 10 times faster than analog modem connections.
- D. They are usually faster than cable and DSL connections.
- E. They require a WiMax tower within 30 miles of the user location.
- F. They use radio waves to communicate with cellular phone towers.

Answer: A B C

Question 6

Which Cisco platform can verify ACLs?

- A. Cisco Prime Infrastructure
- B. Cisco Wireless LAN Controller
- C. Cisco APIC-EM
- D. Cisco IOS-XE

Answer: C

Question 7

What happens when an 802.11a node broadcasts within the range of an 802.11g access point?

- A. The access point transmits, but the node is unable to receive.
- B. A connection occurs.
- C. Both the node and the access point are unable to transmit.
- D. The node transmits, but the access point is unable to receive.

Answer: D

Question 8

Which two statements about access points are true? (Choose two)

- A. They can provide access within enterprises and to the public.
- B. In most cases, they are physically connected to other network devices to provide network connectivity.
- C. They can protect a network from internal and external threats.
- D. Most access points provide Wi-Fi and Bluetooth connectivity.
- E. They must be hardwired to a modem.

Answer: B D

Miscellaneous Questions

<http://www.9tut.com/miscellaneous-questions>

Question 1

What is the authoritative source for an address lookup?

- A. a recursive DNS search
- B. the operating system cache
- C. the ISP local cache
- D. the browser cache

Answer: A

Question 2

Which feature builds a FIB and an adjacency table to expedite packet forwarding?

- A. cut through
- B. fast switching
- C. process switching
- D. Cisco Express Forwarding

Answer: D

Question 3

Which two statements about late collisions are true? (Choose two)

- A. They may indicate a duplex mismatch.
- B. By definition, they occur after the 512th bit of the frame has been transmitted.
- C. They indicate received frames that did not pass the FCS match.
- D. They are frames that exceed 1518 bytes.
- E. They occur when CRC errors and interference occur on the cable.

Answer: A B

Question 4

What feature uses a random time to re-sent a frame?

- A. CSMA/CA
- B. ?
- C. ?
- D. CSMA/CD

Answer: D

Question 5

Which command can you enter to verify echo request and echo reply?

- A. ping
- B. traceroute
- C. tracert
- D. telnet

Answer: A

Question 6

Two features of the extended ping command? (Choose two)

- A. It can send a specific number of packet
- B. It can send packet from specified interface of IP address
- C. It can resolve the destination host name
- D. It can ping multiple host at the same time

Answer: A B

Question 7

What utility is used for shadowed rules?

- A. Create an action plan
- B. Implement an action plan
- C. Gather facts
- D. ?

Answer: B

Question 8

In which two situations should you use out-of-band management?

- A. when a network device fails to forward packets
- B. when you require ROMMON access
- C. when management applications need concurrent access to the device
- D. when you require administrator access from multiple locations
- E. when the control plane fails to respond

Answer: A B

Question 9

Which command shows your active Telnet connections?

- A. show sessions
- B. show cdp neighbors
- C. show users
- D. show queue

Answer: A

Question 10

Which symptom can cause duplex mismatch problem?

- A. no error
- B. collisions on interface
- C. giants
- D. CRC errors

Answer: B

Drag and Drop

<http://www.9tut.com/drag-and-drop>

Question 1

The left describes the types of cables, while the right describes the purposes of the cables. Drag the items on the left to the proper locations. (Not all items can be used.)

crossover	switch access port to router
null modem	switch to switch
straight-through	PC COM to switch Console port
rollover	
9-25 pin serial	

Answer:

- + switch access port to router: straight-through
- + switch to switch: crossover
- + PC COM to switch Console port: rollover

Question 2

Match the items on the left with appropriate OSI layer on the right. (Not all options are used.)

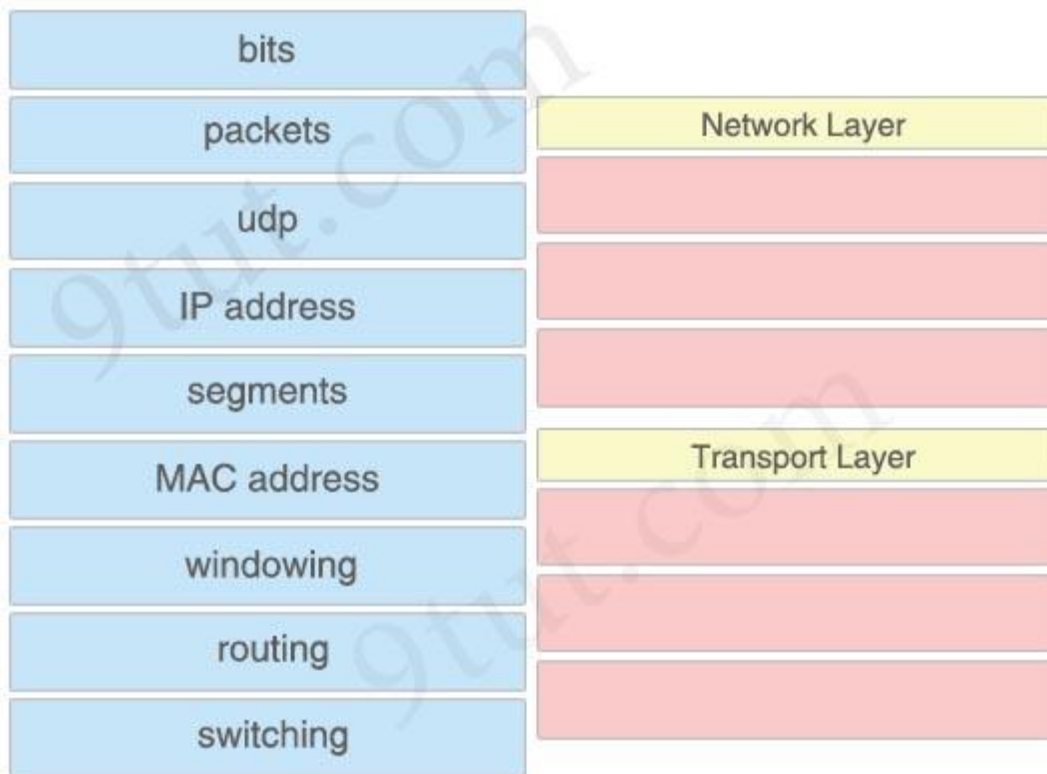

Answer:

Network Layer:

- + packets
- + IP address
- + routing

Transport Layer:

- + udp
- + segments
- + windowing

Question 3

Drag and drop the correct address space on the left to the IPv6 multicast feature or protocol on the right.

FF02::5	All nodes of Link Local
FF02::A	All EIGRPv3 routers
FF02::D	All OSPFv3 Designated routers
FF02::1	All PIM routers
FF05::2	All OSPFv3 routers
FF02::6	All routers of site local

Answer:

- + All nodes of Link Local: FF02::1
- + All EIGRPv3 routers: FF02::A
- + All OSPFv3 Designated routers: FF02::6
- + All PIM routers: FF02::D
- + All OSPFv3 routers: FF02::5
- + All routers of site local: FF05::2

Question 4

A user is unable to connect to the Internet. Based on the layered approach to troubleshooting and beginning with the lowest layer. Follow the guide and drag the contents to relevant modules.

Verify URL	Step 1
Verify NIC operation	Step 2
Verify IP configuration	Step 3
Verify Ethernet cable connection	Step 4
Source	Target

Answer:

- 1) Verify Ethernet cable connection: Step 1
- 2) Verify NIC operation: Step 2
- 3) Verify IP configuration: Step 3
- 4) Verify URL: Step 4

Question 5

The left describes the types of cables, while the right describes the purposes of the cables. Drag the items on the right to the proper locations

crossover	PC to router
DTE/DCE	switch to switch
straight-through	PC to Console
rollover	Serial to Serial

Answer:

crossover: switch to switch
DTE/DCE: Serial to Serial
straight-through: PC to router
rollover: PC to Console

Question 6

Drag the security features on the left to the specific security risks they help protect against on the right. (Not all options are used)

access-group	remote access to device console
console password	access to the console 0 line
enable secret	access to connected networks or resources
CHAP authentication	viewing of passwords
VTY password	access to privileged mode
service password-encryption	

Answer:

- 1) VTY password: remote access to device console
- 2) console password: access to the console 0 line
- 3) access-group: access to connected networks or resources

- 4) service password-encryption: viewing of passwords
- 5) enable secret: access to privileged mode

The unselected left-box – CHAP – is used to verify the identity of the peer by means of a three-way handshake.

Question 7

Drag drop about logging types

accepts incoming connections over vty lines	terminal monitor
displays logging information during a terminal session	syslog server logging
provides local access to a device	buffered logging
stores log messages externally	console
stores log messages in RAM	terminal

Answer:

- + accepts incoming connections over vty lines: terminal
- + displays logging information during a terminal session: terminal monitor
- + provides local access to a device: console
- + stores log messages externally: syslog server logging
- + stores log messages in RAM: buffered logging

Question 8

Drag drop about the difference between CDP and LLDP.

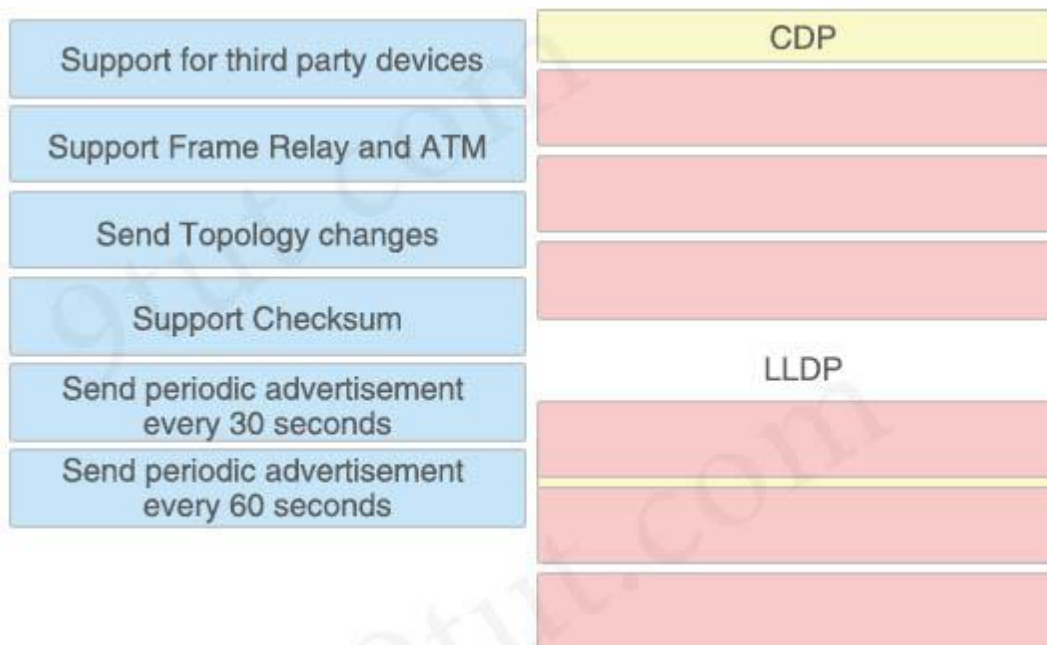

Answer:

CDP

- + Support Frame relay and ATM
- + Support Checksum
- + Send periodic advertisement every 60 seconds

LLDP

- + Support for third party devices
- + Send Topology changes
- + ? (maybe Send periodic advertisement every 30 seconds)

Question 9

Drag drop about logging types

accepts incoming connections over vty lines	terminal monitor
displays logging information during a terminal session	syslog server logging
provides local access to a device	buffered logging
stores log messages externally	console
stores log messages in RAM	terminal

Answer:

- + accepts incoming connections over vty lines: terminal
- + displays logging information during a terminal session: terminal monitor
- + provides local access to a device: console
- + stores log messages externally: syslog server logging
- + stores log messages in RAM: buffered logging

Drag and Drop 2

<http://www.9tut.com/drag-and-drop-2>

Question 1

Drag drop about RIPv1 vs RIPv2

Updates sent in broadcast	RIPv1
Classless	
Classful	
Updates sent in multicast	
Not support authentication	
Support VLSM	RIPv2
Support authentication	
Non support VLSM	

Answer:

RIPv1:

- + Classful
- + Updates sent in broadcast
- + Not support authentication
- + Non support VLSM

RIPv2:

- + Classless
- + Support VLSM
- + Updates sent in multicast
- + Support authentication

Question 2

Drag drop about RADIUS & TACACS+

Multi-vendors	RADIUS
Proprietary	
Separate AAA	
Encrypts the entire body	
Encrypts only the password	
Combines authentication and authorization	TACACS+
UDP	
TCP	

Answer:

RADIUS:

- + Multi-vendors
- + UDP
- + Combines authentication and authorization
- + Encrypts only the password

TACACS+:

- + Proprietary
- + Separate AAA
- + Encrypts the entire body
- + TCP

Question 3

Drag drop about SDN

HTTPS	call to the APIC-EM API from a library
JSON	data-structure format that passes parameters for API calls
OpenFlow	northbound API
RBAC	southbound API
REST	token-based security mechanism

Answer:

- + HTTPS: call to the APIC-EM API from a library
- + JSON: data-structure format that passes parameters for API calls
- + OpenFlow: southbound API
- + RBAC: token-based security mechanism
- + REST: northbound API

Question 4

Drag drop about Static routing vs Dynamic routing

Allows the administrator to manage devices individually when needed	Static Routing
Able to select the best path in response to network changes	
Supports load balancing with no specific configuration	
Provides granular control over routing	
Supports floating routes	Dynamic Routing
Provides better scalability in a large infrastructure	

Answer:

Static Routing:

- + Allows the administrator to manage devices individually when needed
- + Supports floating routes
- + Provides granular control over routing

Dynamic Routing:

- + Able to select the best path in response to network changes
- + Supports load balancing with no specific configuration
- + Provides better scalability in a large infrastructure

Question 5

Drag drop about DNS services

cache	local database of address mappings that improves name-resolution performance
DNS	service that maps hostnames to IP addresses
domain	disables DNS services on a Cisco device
name resolver	in response to client requests, queries a name server for IP address information
no ip domain-lookup	component of a URL that indicates the location or organization type, such as .com or .edu

Answer:

- + cache: local database of address mappings that improves name-resolution performance
- + DNS: service that maps hostnames to IP addresses
- + no ip domain-lookup: disables DNS services on a Cisco device
- + name resolver: in response to client requests, queries a name server for IP address information
- + domain: component of a URL that indicates the location or organization type, such as .com or .edu

Question 6

Drag drop about characteristics of a cloud environment.

Multitenancy	One or more clients can be hosted with the same physical or virtual infrastructure
On-demand	Resources can be added and removed as needed to support current workload and tasks
Resiliency	Tasks can be migrated to different physical locations to increase efficiency or reduce cost
Scalability	Resources are dedicated only when necessary instead of on a permanent basis
Workload movement	Tasks and data residing on a failed server can be seamlessly migrated to other physical resources

Answer:

- + Multitenancy: One or more clients can be hosted with the same physical or virtual infrastructure
- + Scalability: Resources can be added and removed as needed to support current workload and tasks
- + Workload movement: Tasks can be migrated to different physical locations to increase efficiency or reduce cost
- + On-demand: Resources are dedicated only when necessary instead of on a permanent basis
- + Resiliency: Tasks and data residing on a failed server can be seamlessly migrated to other physical resources

Question 7

Drag the “show” commands on the left to their proper locations on the right

show ip eigrp traffic	show EIGRP routing tables in routing table / confirm what is actually being used / does routing
show ip route eigrp	show information about interface configured for EIGRP / Verify the routing of specific interface / show what being used
show ip eigrp topology	show the number of EIGRP packets sent and received
show ip eigrp interface	Displays the neighbor discovered by EIGRP. Show what is learned
show ip eigrp neighbors	shows the routes known to a router's EIGRP routing process. Confirm what EIGRP Learning show what does it learned

Answer:

- + **show ip route eigrp**: show EIGRP routing tables in routing table / confirm what is actually being used / does routing
- + **show ip eigrp interface**: show information about interface configured for EIGRP / Verify the routing of specific interface / show what being used
- + **show ip eigrp traffic**: show the number of EIGRP packets sent and received
- + **show ip eigrp neighbors**: Displays the neighbor discovered by EIGRP. Show what is learned
- + **show ip eigrp topology**: shows the routes known to a router's EIGRP routing process. Confirm what EIGRP learning. Show what does it learned

Question 8

Drag and drop the steps to configure EIGRP IPv6 into the appropriate order.

ipv6 router eigrp <i>as-number</i>	Step 1
enable	Step 2
configure terminal	Step 3
ipv6 eigrp <i>as-number</i> (under interface mode)	Step 4
router id	Step 5

Answer:

- Step 1: enable
- Step 2: configure terminal
- Step 3: ipv6 router eigrp as-number
- Step 4: router id
- Step 5: ipv6 eigrp as-number (under interface mode)

Question 9

Drag and drop the steps in the process of upgrading the IOS on a Cisco router.

Use FTP or TFTP to copy the new IOS to the device	Step 1
Reboot and verify the IOS running version	Step 2
Verify the available flash memory on the device	Step 3
Update the boot statement	Step 4
Verify the checksum of the new IOS version	Step 5

Answer:

- Step 1: Verify the available flash memory on the device
- Step 2: Use FTP or TFTP to copy the new IOS to the device
- Step 3: Verify the checksum of the new IOS version
- Step 4: Update the boot statement
- Step 5: Reboot and verify the IOS running version

Question 10

Drag and drop about data unit for OSI model to the correspondent places.

Physical	Frame
Data Link	Data Stream
Network	Packet
Transport	Bit
Session	Segment

Answer:

- Physical: Bit
- Data Link: Frame
- Network: Packet
- Transport: Segments
- Session: Data Stream

Drag and Drop 3

<http://www.9tut.com/drag-and-drop-3>

Question 1

Drag and drop the items on the left to the correct sequence of an Ethernet frame.

Destination Address	1
Type	2
Preamble	3
SFD (Start of Frame Delimiter)	4
Source Address	5
FCS	6
Data	7

Answer:

- 1: Preamble
- 2: SFD (Start of Frame Delimiter)
- 3: Destination Address
- 4: Source Address
- 5: Type
- 6: Data
- 7: FCS

Ethernet (802.3) Frame Format							
7 bytes	1 byte	6 bytes	6 bytes	2 bytes	42 to 1500 bytes	4 bytes	12 bytes
Preamble	Start of Frame Delimiter	Destination MAC Address	Source MAC Address	Type	Data (payload)	CRC	Inter-frame gap

Question 2

Drag drop about STP port roles.

alternate	path to the root bridge that excludes the root port
designated	elect port for an individual LAN segment
disable	port that is excluded from the spanning-tree process
root	elected port for the spanning tree topology as a whole

Answer:

- + alternate: elected port for the spanning tree topology as a whole
- + designated: path to the root bridge that excludes the root port
- + disable: port that is excluded from the spanning-tree process
- + root: elect port for an individual LAN segment

Question 3

Drag drop about DNS related commands.

ip dns-server	enable dns lookup
ip domain list	specifies the default domain to append to unqualified host name
ip domain lookup	enable the DNS server on the device
ip domain name	statically map on ip address to host name
ip host	specifies a sequence of domain names
ip name-server	identified a DNS server to provide lookup service

Answer:

- + ip dns-server: enable the DNS server on the device
- + ip domain list: specifies a sequence of domain names.
- + ip domain lookup: enable dns lookup
- + ip domain name: specifies the default domain to append to unqualified host name.
- + ip host: statically map on ip address to host name
- + ip name-server: identified a DNS server to provide lookup service

Question 4

Drag drop about TCP and UDP. Classify which protocols run TCP or UDP.

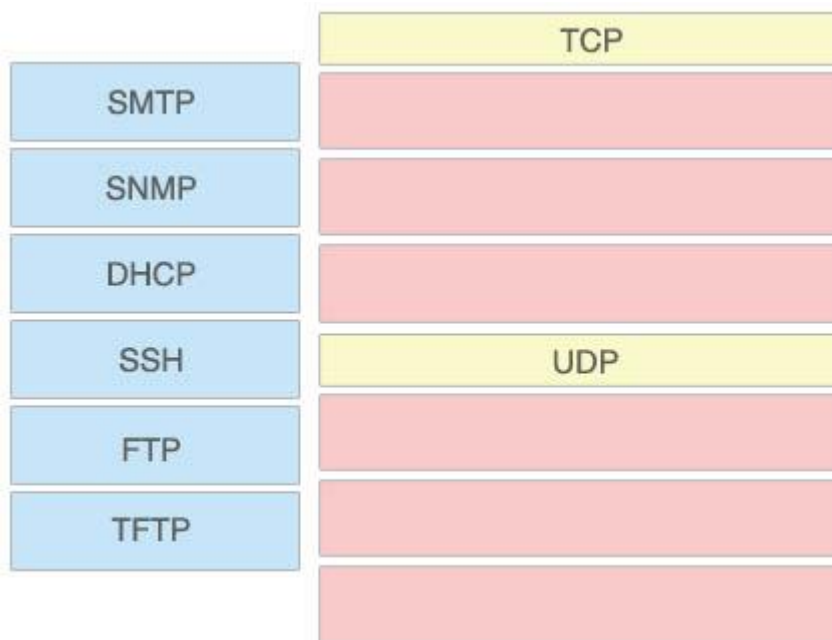

Answer:

TCP:

- + SMTP
- + SSH
- + FTP

UDP:

- + SNMP
- + DHCP
- + TFTP

Question 5

Arrange in the order of creation of GRE tunnel

Answer:

Step 1: Create tunnel interface

Step 2: Specify carrier protocol (like tunnel GRE)

Step 3: Specify passenger protocol (IPv4 or IPv6)

Step 4: Add source and destination on tunnel interface

RIPv2 Troubleshooting Sim

<http://www.9tut.com/ripv2-troubleshooting-sim>

Refer to the topology below and answer the questions using “show” commands.

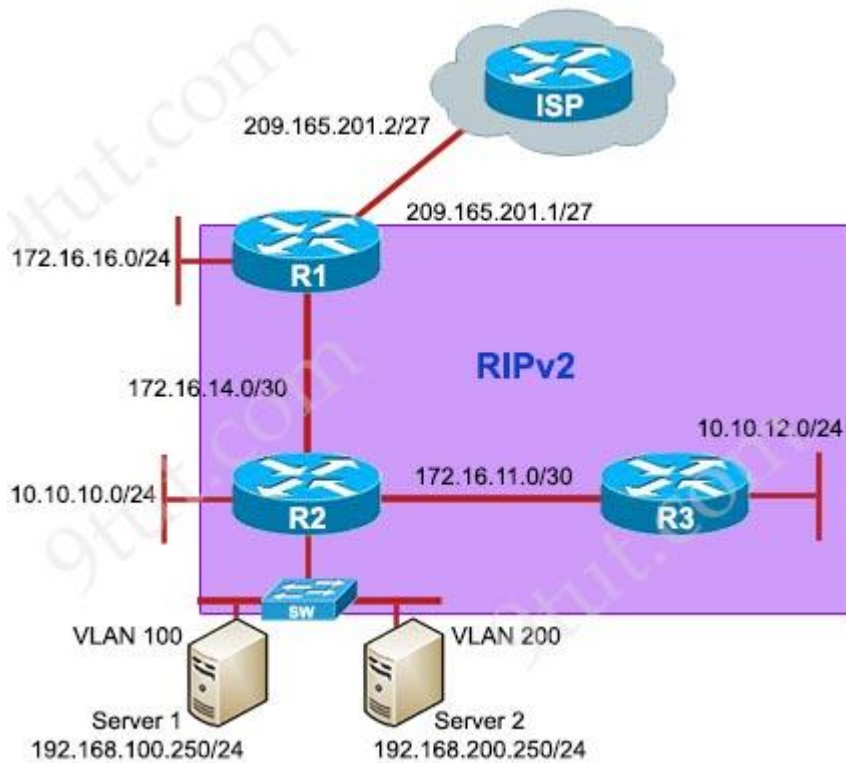

Question 1

Server1 and Server2 are unable to communicate with the rest of the network. Your initial check with system administrators shows that IP address settings are correctly configured on the server side. What could be an issue?

- A. The VLAN encapsulation is misconfigured on the router subinterfaces.
- B. The Router is missing subinterface configuration.
- C. The Trunk is not configured on the L2SW1 switch.
- D. The IP address is misconfigured on the primary router interface.

Answer: A

Question 2

Users in the main office complain that they are unable to reach internet sites. You observe that internet traffic that is destined towards ISP router is not forwarded correctly on Router R1. What could be an issue?

Ping to Internet server shows the following results from R1:

```
R1#ping 209.165.200.225
Type escape sequence to abort.
Sending 5, 100-byte ICMP Echos to 209.165.200.225, timeout is 2 seconds:
.....
Success rate is 0 percent (0/5)
```

- A. The next hop router address for the default route is incorrectly configured.
- B. Default route pointing to ISP router is not configured on Router R1.
- C. Default route pointing to ISP router is configured with AD of 225.
- D. Router R1 configured as DHCP client is not receiving default route via DHCP from ISP router.

Answer: B

Question 3

Examine R2 configuration, the traffic that is destined to R3 LAN network sourced from Router R2 is forwarded to R1 instead R3. What could be an issue?

```
R2#traceroute 10.10.12.1 source 10.10.10.1
Type escape sequence to abort.
Tracing the route to 10.10.12.1
VRF info: (vrf in name/id, vrf out name/id)
 0 172.16.14.1 0 msec 1 msec 0 msec
 1 172.16.14.1 !H !H *
```

R2#

- A. RIPv2 enabled on R3, but R3 LAN network that is not advertised into RIPv2 domain.
- B. RIPv2 routing updates are suppressed between R2 and R3 using passive interface feature.
- C. RIPv2 not enabled on R3.
- D. No issue that is identified; this behavior is normal since default route propagated into RIPv2 domain by Router R1.

Answer: C

Question 4

What is the correct statement below after examining the R1 routing table?

- A. Traffic that is destined to 10.10.10.0/24 from R1 LAN network uses static route instead RIPv2 because the static route AD that is configured is less than the AD of RIPv2
- B. Traffic that is destined to 10.10.10.0/24 from R1 LAN network uses RIPv2 instead of static route because the static route AD that is configured is higher than the AD of RIPv2
- C. Traffic that is destined to 10.10.10.0/24 from R1 LAN network uses static route instead of RIPv2 but the traffic is forwarded to the ISP instead of the internal network
- D. Traffic that is destined to 10.10.10.0/24 from R1 LAN network uses RIPv2 instead of static route because the static route AD that is configured is 255

Answer: B

DHCP Sim

<http://www.9tut.com/dhcp-sim>

Refer to the topology below and answer the questions.

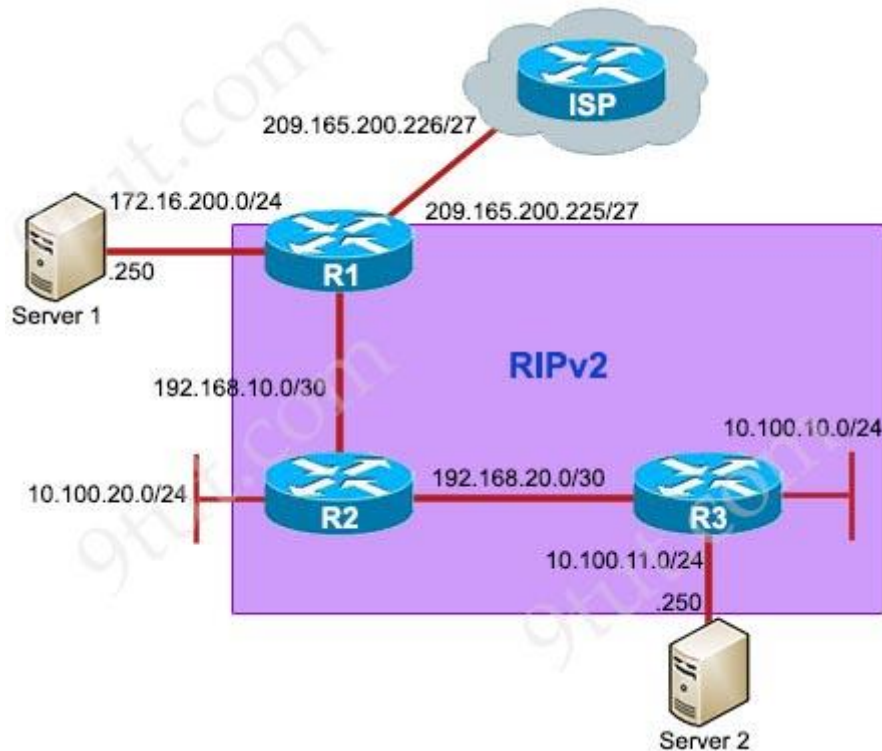

Question 1

Examine the DHCP configuration between R2 and R3, R2 is configured as the DHCP server and R3 as the client. What is the reason R3 is not receiving the IP address via DHCP?

- A. On R3, DHCP is not enabled on the interface that is connected to R2.
- B. On R3, the interface that is connected to R2 is in shutdown condition.
- C. On R2, the interface that is connected to R3 is in shutdown condition.
- D. On R2, the network statement in the DHCP pool configuration is incorrectly configured.

Answer: A

Question 2

R1 router clock is synchronized with ISP router. R2 is supposed to receive NTP updates from R1. But you observe that R2 clock is not synchronized with R1. What is the reason R2 is not receiving NTP updates from R1?

- A. R1 router Ethernet interface that is connected to R2 is placed in shutdown condition.
- B. R2 router Ethernet interface that is connected to R1 is placed in shutdown condition.

- C. The NTP server command not configured on R2 router.
- D. The IP address that is used in the NTP configuration on R2 router is incorrect.

Answer: D

Question 3

Why applications that are installed on PC's in R2 LAN network 10.100.20.0/24 are unable to communicate with Server1?

- A. A standard ACL statement that is configured on R1 is blocking the traffic sourced from R2 LAN network.
- B. A standard ACL statement that is configured on R1 is blocking the traffic sourced from Server1 network.
- C. A standard ACL statement that is configured on R2 is blocking the traffic sourced from Server1 network.
- D. A standard ACL statement that is configured on R2 is blocking the traffic sourced from R2 LAN network.

Answer: C

Question 4

Users complain that they are unable to reach internet sites. You are troubleshooting internet connectivity problem at main office. Which statement correctly identifies the problem on Router R1?

- A. NAT configurations on the interfaces are incorrectly configured.
- B. NAT translation statement incorrectly configured.
- C. Interesting traffic for NAT ACL is incorrectly configured.
- D. Only static NAT translation configured from the server, missing Dynamic NAT or Dynamic NAT overloading for internal networks.

Answer: A

EIGRP Troubleshooting Sim

<http://www.9tut.com/eigrp-troubleshooting-sim>

Question

Refer to the topology. Your company has connected the routers R1, R2 and R3 with serial links. R2 and R3 are connected to the switches SW1 and SW2, respectively. SW1 and SW2 are also connected to the routers R4 and R5.

The EIGRP routing protocol is configured. You are required to troubleshoot and resolve the EIGRP issues between the various routers. Use the appropriate show commands to troubleshoot the issues.



Question 1

The loopback interfaces on R4 with the IP addresses of 10.4.4.4/32, 10.4.4.5/32 and 10.4.4.6/32 are not appearing in the routing table of R5. Why are the interfaces missing?

- A. The interfaces are shutdown, so they are not being advertised.
- B. R4 has been incorrectly configured to be in another AS, so it does not peer with R5.
- C. Automatic summarization is enabled, so only the 10.0.0.0 network is displayed.
- D. The loopback addresses haven't been advertised, and the network command is missing on R4.

Answer: B

Question 2

Which path does traffic take from R1 to R5?

- A. The traffic goes through R2.
- B. The traffic goes through R3.
- C. The traffic is equally load-balanced over R2 and R3.
- D. The traffic is unequally load-balanced over R2 and R3.

Answer: A

Question 3

Router R6 does not form an EIGRP neighbor relationship correctly with router R1. What is the cause for this misconfiguration?

- A. The K values mismatch.
- B. The AS does not match.
- C. The network command is missing.
- D. The passive-interface command is enabled.

Answer: C

Question 4

Study the following output taken on R1:

```
R1#ping 10.5.5.55 source 10.1.1.1
Type escape sequence to abort.
Sending 5, 100-byte ICMP Echos to 10.5.5.55, timeout is 2 seconds:
Packet sent with a source address of 10.1.1.1
.....
Success rate is 0 percent (0/5)
```

Why are the pings failing?

- A. The network statement is missing on R5.
- B. The loopback interface is shut down on R5.
- C. The network statement is missing on R1.
- D. The IP address that is configured on the Lo1 interface on R5 is incorrect.

Answer: C

OSPF Neighbor Sim

<http://www.9tut.com/ospf-neighbor-sim>

Question

Refer to the topology. Your company has decided to connect the main office with three other remote branch offices using point-to-point serial links. You are required to troubleshoot and resolve OSPF neighbor adjacency issues between the main office and the routers located in the remote branch offices.

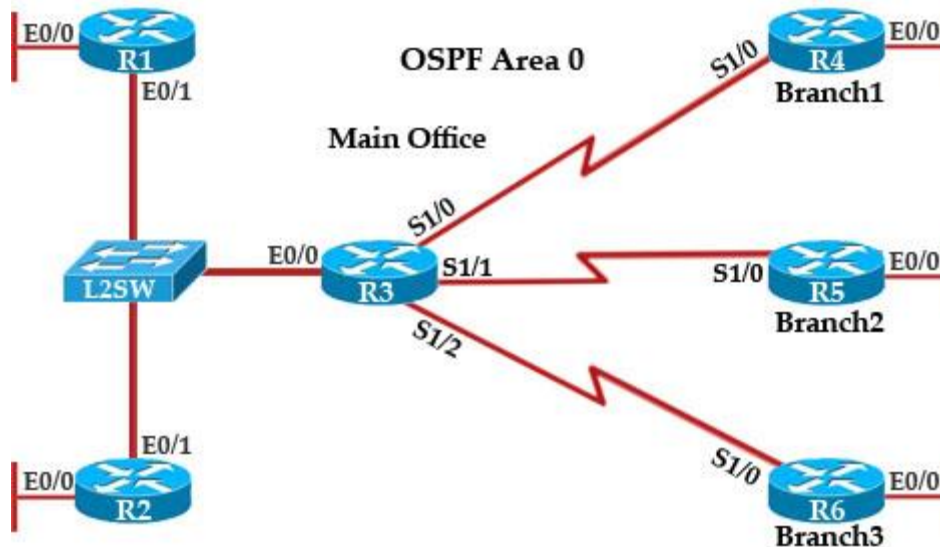

Question 1

An OSPF neighbor adjacency is not formed between R3 in the main office and R4 in the Branch1 office. What is causing the problem?

- A. There is an area ID mismatch.
- B. There is a Layer 2 issue; an encapsulation mismatch on serial links.
- C. There is an OSPF hello and dead interval mismatch.
- D. The R3 router ID is configured on R4.

Answer: A

Question 2

An OSPF neighbor adjacency is not formed between R3 in the main office and R5 in the Branch2 office. What is causing the problem?

- A. There is an area ID mismatch.
- B. There is a PPP authentication issue; a password mismatch.
- C. There is an OSPF hello and dead interval mismatch.
- D. There is a missing network command in the OSPF process on R5.

Answer: C

Question 3

R1 does not form an OSPF neighbor adjacency with R2. Which option would fix the issue?

- A. R1 ethernet0/1 is shutdown. Configure no shutdown command.
- B. R1 ethernet0/1 configured with a non-default OSPF hello interval of 25; configure no ip ospf

hello-interval 25

C. R2 ethernet0/1 and R3 ethernet0/0 are configured with a non-default OSPF hello interval of 25; configure no ip ospf hello-interval 25

D. Enable OSPF for R1 ethernet0/1; configure ip ospf 1 area 0 command under ethernet0/1

Answer: B

Question 4

An OSPF neighbor adjacency is not formed between R3 in the main office and R6 in the Branch3 office. What is causing the problem?

A. There is an area ID mismatch.

B. There is a PPP authentication issue; the username is not configured on R3 and R6.

C. There is an OSPF hello and dead interval mismatch.

D. The R3 router ID is configured on R6.

Answer: D

CCNA VTP SIM Question

<http://www.9tut.com/80-ccna-vtp-sim-question>

Question

This task requires you to use the CLI of Sw-AC3 to answer five multiple-choice questions. This does not require any configuration.

To answer the multiple-choice questions, click on the numbered boxes in the right panel.

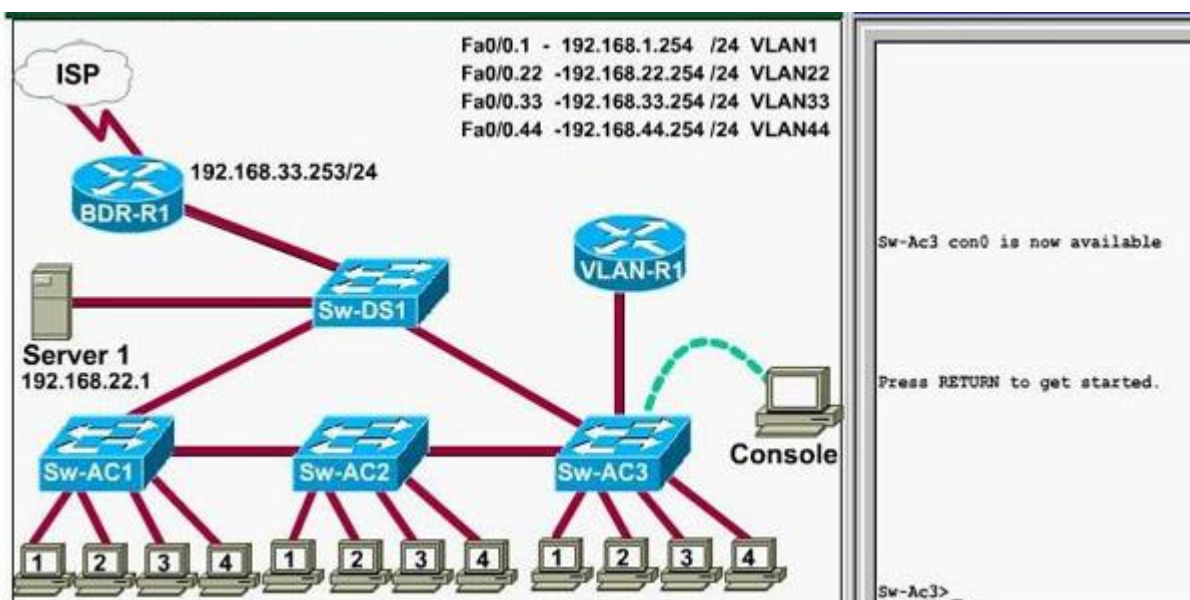

There are five multiple-choice questions with this task. Be sure to answer all five questions before leaving this item.

Notice: All the images in this VTP LAB are used for demonstration only, you will see slightly different images in the real CCNA exam. You can download this sim to practice here (but notice that this sim is not perfect, only for practicing purpose):

http://www.9tut.com/download/9tut.com_CCNA_vtp_sim.pka

Note: In this VTP sim, you have to answer 5 questions. After answering the first question, click on the number boxes to move to other questions. If you click “Next” at the first question, you will lose points for 4 remaining questions.

Question 1

What interface did Sw-AC3 associate with source MAC address 0010.5a0c.ffba ?

- a) Fa0/1
- b) Fa0/3
- c) Fa0/6
- d) Fa0/8
- e) Fa0/9
- f) Fa0/12

Answer: Fa 0/8

Question 2

What ports on Sw-AC3 are operating has trunks (choose three)?

- a) Fa0/1
- b) Fa0/3
- c) Fa0/4
- d) Fa0/6
- e) Fa0/9
- f) Fa0/12

Answer: Fa0/3, Fa0/9 and Fa0/12

Question 3

What kind of router is VLAN-R1?

- a) 1720
- b) 1841
- c) 2611
- d) 2620

Answer: 2620

Question 4

Which switch is the root bridge for VLAN 1?

Answer: Sw-DS1

Question 5

What address should be configured as the default-gateway for the host connected to interface fa 0/4 of SW-Ac3?

Answer: 192.168.44.254

Question 6

From which switch did Sw-Ac3 receive VLAN information ?

Answer: Sw-AC2

Question 7

Refer to the exhibit, SwX was taken out of the production network for maintenance. It will be reconnected to the Fa 0/16 port of Sw-Ac3. What happens to the network when it is reconnected and a trunk exists between the two switches?

SwX#show vlan				SwX# show vtp stat	
VLAN Name	Status	Ports		VTP Version	: 2
.....					
1	default	active	Fa0/1, Fa0/2, Fa0/3 Fa0/4, Fa0/5, Fa0/6 Fa0/7, Fa0/8, Fa0/9 Fa0/10, Fa0/11, Fa0/12 Gi0/1, Gi0/2	Configuration Revision	: 6
2	students	active		Maximum VLANs supported locally	: 250
3	admin	active		Number of existing VLANs	: 8
4	faculty	active		VTP Operating Mode	: Server
				VTP Domain Name	: home-office
				VTP Pruning Mode	: Disabled
				VTP V2 Mode	: Disabled
				VTP Traps Generation	: Disabled
				MD5 digest	: 0xD8 0xD8 0x38 0x22 0x98 0xE3 0xAC 0x65
				Configuration last modified by	0.0.0.0 at 3-28-99 01:24:88

A – All VLANs except the default VLAN will be removed from all switches

B – All existing switches will have the students, admin, faculty, Servers, Management, Production, and no-where VLANs

C – The VLANs Servers, Management, Production and no-where will replace the VLANs on SwX

D – The VLANs Servers, Management, Production and no-where will be removed from existing switches

Answer: D

Question 8

Out of which ports will a frame be forwarded that has source mac-address 0010.5a0c.fd86 and destination mac-address 000a.8a47.e612? (Choose three)

A – Fa0/8

B – Fa0/3

C – Fa0/1

D – Fa0/12

Answer: B C D

Question 9

If one of the host connected to Sw-AC3 wants to send something for the ip 190.0.2.5 (or any ip that is not on the same subnet) what will be the destination MAC address?

CCNA Access List Sim 2

<http://www.9tut.com/78-ccna-access-list-sim-2>

Question

Security is being added to the Corp1 router. The user on host C should be able to use a web browser to access financial information from the Finance Web Server. No other hosts from the LAN nor the Core should be able to use a web browser to access this server. Since there are multiple resources for the corporation at this location including other resources on the Finance Web Server, all other traffic should be allowed.

The task is to create and apply a numbered access-list with no more than three statements that will allow ONLY host C web access to the Finance Web Server. No other hosts will have web access to the Finance Web Server. All other traffic is permitted.

Access to the router CLI can be gained by clicking on the appropriate host.

All passwords have been temporarily set to "cisco".

The Core connection uses an IP address of 198.18.196.65

The computers in the Hosts LAN have been assigned addresses of 192.168.33.1 – 192.168.33.254

Host A 192.168.33.1

Host B 192.168.33.2

Host C 192.168.33.3

Host D 192.168.33.4

The servers in the Server LAN have been assigned addresses of 172.22.242.17 – 172.22.242.30

The Finance Web Server is assigned an IP address of 172.22.242.23.

The Public Web Server is assigned an IP address of 172.22.242.17

CCNA Access List Sim

<http://www.9tut.com/70-ccna-access-list-sim>

Question

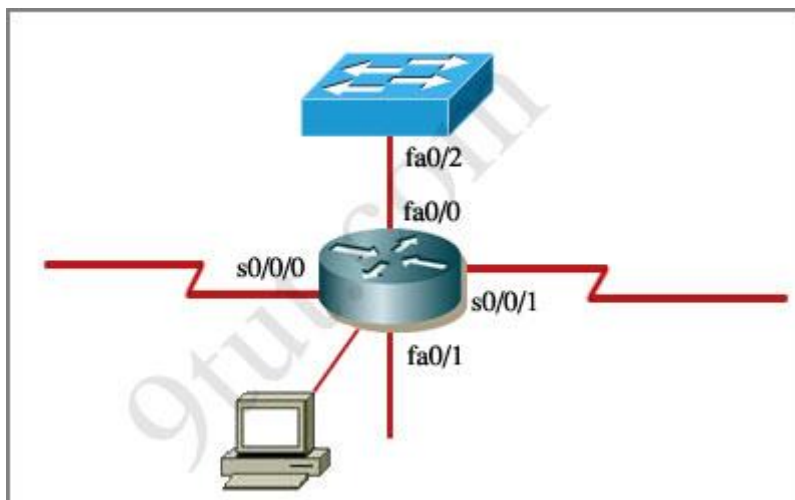

An administrator is trying to ping and telnet from Switch to Router with the results shown below:

```
Switch>
```

```
Switch> ping 10.4.4.3
```

Type escape sequence to abort.

Sending 5, 100-byte ICMP Echos to 10.4.4.3, timeout is 2 seconds:

.U.U.U

Success rate is 0 percent (0/5)

Switch>

Switch> telnet 10.4.4.3

Trying 10.4.4.3 ...

% Destination unreachable; gateway or host down

Switch>

Click the console connected to Router and issue the appropriate commands to answer the questions.

CCNA NAT SIM Question 2

<http://www.9tut.com/57-ccna-nat-sim-question-2>

Question

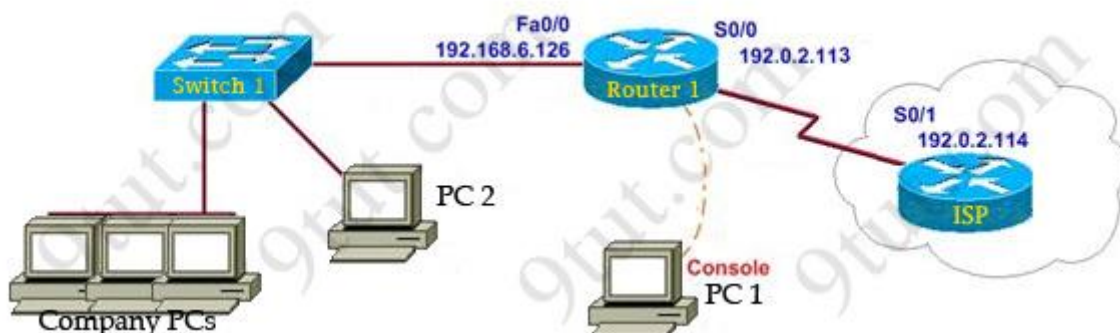

CCNA EIGRP LAB Question

<http://www.9tut.com/64-ccna-eigrp-lab-question>

Question

After adding R3 router, no routing updates are being exchanged between R3 and the new location. All other inter connectivity and Internet access for the existing locations of the company are working properly.

The task is to identify the fault(s) and correct the router configuration to provide full connectivity between the routers.

Access to the router CLI can be gained by clicking on the appropriate host. All passwords on all routers are cisco.

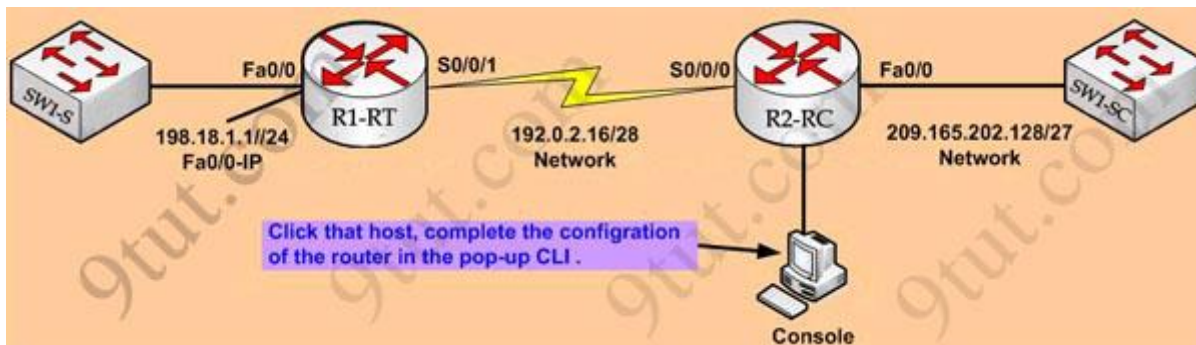

CCNA Training Company recently installed a new router in their office. Complete the network installation by performing the initial router configurations and configuring RIPV2 routing using the router command line interface (CLI) on the R2-RC.

Name of the router is **R2-RC**

Enable-secret password is **cisco1**

The password to access user EXEC mode using the console is **cisco2**

The password to allow telnet access to the router is **cisco3**

IPv4 addresses must be configured as follows:

Ethernet network **209.165.202.128/27** – router has last assignable host address in subnet

Serial network is **192.0.2.16/28** – router has last assignable host address in the subnet. Interfaces should be enabled.

Router protocol is **RIP V2**

Attention :

In practical examinations, please note the following, the actual information will prevail.

1. Name of the router is xxx
2. Enable-secret password is xxx
3. Password to access user EXEC mode using the console is xxx
4. The password to allow telnet access to the router is xxx
5. IP information

CCNA NAT SIM Question 1

<http://www.9tut.com/52-ccna-nat-sim-question>

Question

A network associate is configuring a router for the CCNA Training company to provide internet access. The ISP has provided the company six public IP addresses of 198.18.184.105 198.18.184.110. The company has 14 hosts that need to access the internet simultaneously. The hosts in the CCNA Training company LAN have been assigned private space addresses in the range of 192.168.100.17 – 192.168.100.30.

The task is to complete the NAT configuration using all IP addresses assigned by the ISP to provide Internet access for the hosts in the Weaver LAN. Functionality can be tested by clicking on the host provided for testing.

Configuration information

router name – Weaver

inside global addresses – 198.18.184.105 198.18.184.110/29

inside local addresses – 192.168.100.17 – 192.168.100.30/28

number of inside hosts – 14

The following have already been configured on the router :

- The basic router configuration
- The appropriate interfaces have been configured for NAT inside and NAT outside
- The appropriate static routes have also been configured (since the company will be a stub network, no routing protocol will be required.)
- All passwords have been temporarily set to “cisco”

The task is to complete the NAT configuration using all IP addresses assigned by the ISP to provide Internet access for the hosts in the Weaver LAN. Functionality can be tested by clicking on the host provided for testing.

Configuration information

router name - Weaver

inside global addresses-198.18.184.105 198.18.184.110/29

inside local addresses - 192.168.100.17 - 192.168.100.30/28

number of inside hosts - 14

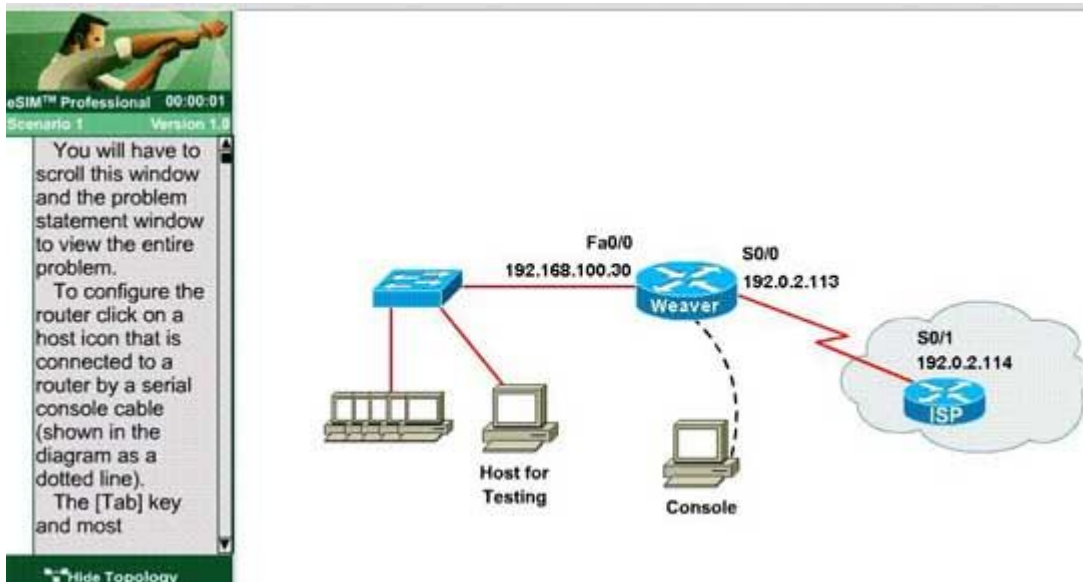

GRE Multilink Sim

<http://www.9tut.com/gre-multilink-sim>

Refer to the topology below and answer the following questions.

<https://t.me/learningnets>

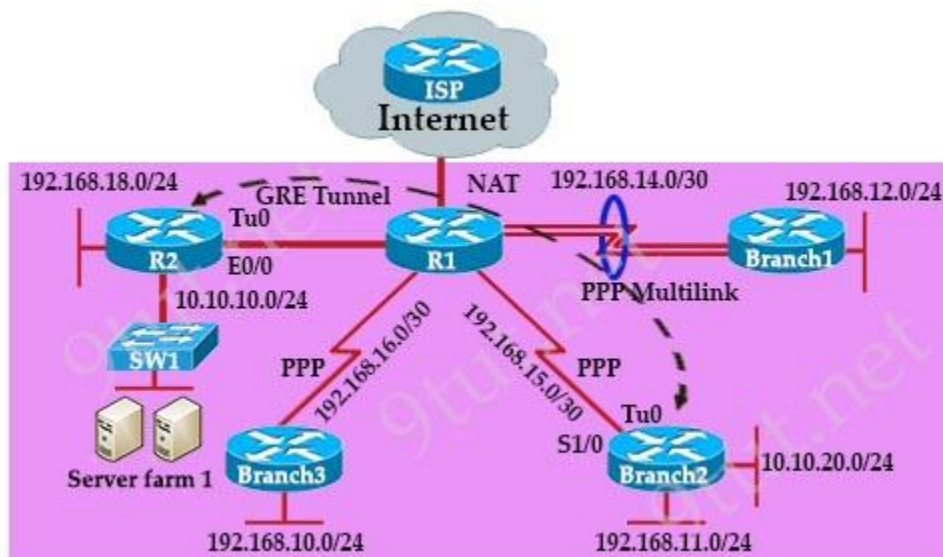

Question 1

Why is the Branch2 network 10.10.20.0/24 unable to communicate with the Server farm 1 network 10.10.10.0/24 over the GRE tunnel?

- A. The GRE tunnel destination is not configured on the R2 router.
- B. The GRE tunnel destination is not configured on the Branch2 router.
- C. The static route points to the tunnel0 interface that is misconfigured on the Branch2 router.
- D. The static route points to the tunnel0 interface that is misconfigured on the R2 router.

Answer: C

Question 2

Why has the Branch3 router lost connectivity with R1? Use only show commands to troubleshoot because usage of the debug command is restricted on the Branch3 and R1 routers?

- A. A PPP chap hostname mismatch is noticed between Branch3 and R1.
- B. A PPP chap password mismatch is noticed between Branch3 and R1.
- C. PPP encapsulation is not configured on Branch3.
- D. The PPP chap hostname and PPP chap password commands are missing on the Branch3 router.

Answer: A

Question 3

Which statement about the router configurations is correct?

- A. PPP PAP is authentication configured between Branch2 and R1.
- B. Tunnel keepalives are not configured for the tunnel0 interface on Branch2 and R2.
- C. The Branch2 LAN network 192.168.11.0/24 is not advertised into the EIGRP network.
- D. The Branch3 LAN network 192.168.10.0/24 is not advertised into the EIGRP network.
- E. PPP CHAP is authentication configured between Branch1 and R1.

Answer: D

Question 4

Why did Branch1 router lose WAN connectivity with R1 router?

- A. The IP address is misconfigured on PPP multilink interface on the Branch1 router.
- B. The PPP multilink group is misconfigured on the Branch1 serial interfaces.
- C. The PPP multilink group is misconfigured on the R1 serial interfaces.
- D. The Branch1 serial interfaces are placed in a shutdown condition.

Answer: A

IPv6 OSPF Sim

<http://www.9tut.com/ipv6-ospf-sim>

Question

All routers are running IPv6 OSPF with process ID 100. The loopback0 IPv4 address is the OSPF router ID of each router.

On HQ router, a provider link is provided and you have to configure an IPv6 default route on HQ and make sure this route is advertised in IPv6 OSPF process. Also troubleshoot why HQ is not forming IPv6 OSPF neighbor with BR.

Requirements:

1. Configure IPv6 default route on HQ router with default gateway of 2001:DB8:B:B1B2::1
2. Verify by pinging provider test IPv6 address 2001:DB8:0:1111::1 after configuring default route on HQ
3. Make sure that the default route is advertised in IPv6 OSPF router HQ. This default route should be advertised only when HQ has a default route in its routing table
4. Router HQ is not forming IPv6 OSPF neighbor with BR. Troubleshoot and solve the problem

