

## 200-301.prepaway.premium.exam.102q

Number: 200-301  
Passing Score: 800  
Time Limit: 120 min  
File Version: 1.0



**200-301**

**Cisco Certified Network Associate**

**Version 1.0**

### **Sections**

1. Network Fundamentals
2. Network Access
3. IP Connectivity
4. IP Services
5. Security Fundamentals
6. Automation and Programmability

Exam A

QUESTION 1

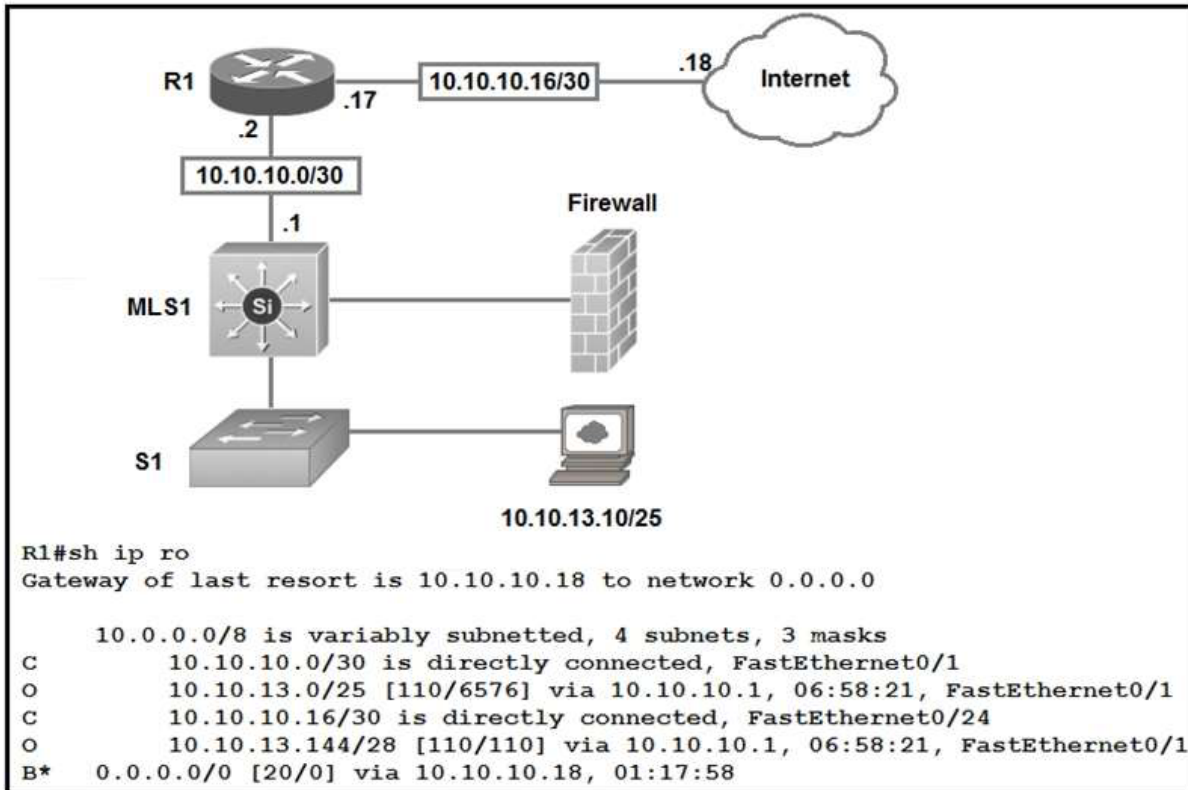

Refer to the exhibit. Which type of route does R1 use to reach host 10.10.13.10/32?

- A. default route
- B. network route
- C. host route
- D. floating static route

**Correct Answer: B**

**Section: Network Fundamentals**

**Explanation**

**Explanation/Reference:**

QUESTION 2

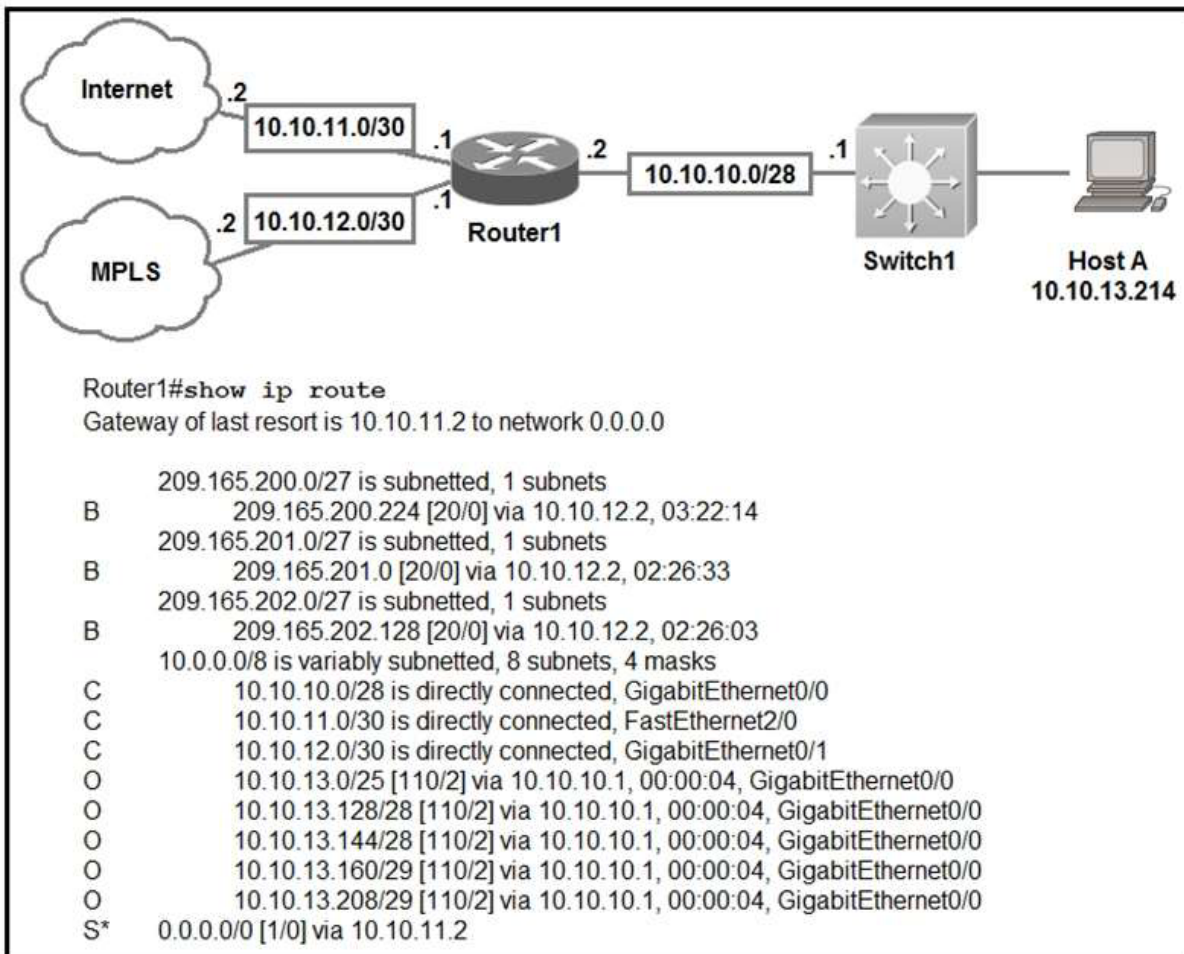

Refer to the exhibit. Which prefix does Router1 use to Host A?

- A. 10.10.10.0/28
- B. 10.10.13.0/25
- C. 10.10.13.144/28
- D. 10.10.13.208/29

**Correct Answer: D**

**Section: Network Fundamentals**

**Explanation**

**Explanation/Reference:**

**QUESTION 3**

DRAG DROP

Drag and drop the descriptions of file-transfer protocols from the left onto the correct protocols on the right.

**Select and Place:**

## Answer Area

provides reliability when loading an IOS image upon boot up
does not require user authentication
uses port 69
uses ports 20 and 21
uses TCP
uses UDP

FTP	
TFTP	

Correct Answer:

## Answer Area

provides reliability when loading an IOS image upon boot up
does not require user authentication
uses port 69
uses ports 20 and 21
uses TCP
uses UDP

FTP	uses ports 20 and 21
	provides reliability when loading an IOS image upon boot up
	uses TCP
TFTP	uses port 69
	does not require user authentication
	uses UDP

Section: Network Fundamentals  
Explanation

Explanation/Reference:

**QUESTION 4**

A frame that enters a switch fails the Frame Check Sequence. Which two interface counters are incremented?  
(Choose two.)

- A. input errors
- B. frame
- C. giants
- D. CRC
- E. runts

**Correct Answer:** AD

**Section:** Network Fundamentals

**Explanation**

**Explanation/Reference:**

**QUESTION 5**

DRAG DROP

Drag and drop the IPv4 network subnets from the left onto the correct usable host ranges on the right.

**Select and Place:**

**Answer Area**

172.28.228.144/18	172.28.228.1 - 172.28.229.254
172.28.228.144/21	172.28.224.1 - 172.28.231.254
172.28.228.144/23	172.28.228.129 - 172.28.228.254
172.28.228.144/25	172.28.228.145 - 172.28.228.150
172.28.228.144/29	172.28.192.1 - 172.28.255.254

**Correct Answer:**

## Answer Area

172.28.228.144/18	172.28.228.144/23
172.28.228.144/21	172.28.228.144/21
172.28.228.144/23	172.28.228.144/25
172.28.228.144/25	172.28.228.144/29
172.28.228.144/29	172.28.228.144/18

### Section: Network Fundamentals

#### Explanation

#### Explanation/Reference:

#### QUESTION 6

How do TCP and UDP differ in the way that they establish a connection between two endpoints?

- A. TCP uses the three-way handshake, and UDP does not guarantee message delivery.
- B. TCP uses synchronization packets, and UDP uses acknowledgement packets.
- C. UDP provides reliable message transfer, and TCP is a connectionless protocol.
- D. UDP uses SYN, SYN ACK, and FIN bits in the frame header while TCP uses SYN, SYN ACK, and ACK bits.

**Correct Answer:** A

### Section: Network Fundamentals

#### Explanation

#### Explanation/Reference:

#### QUESTION 7

Which 802.11 frame type is association response?

- A. management
- B. protected frame
- C. action
- D. control

**Correct Answer:** A

### Section: Network Fundamentals

#### Explanation

#### Explanation/Reference:

Reference: [https://en.wikipedia.org/wiki/802.11\\_Frame\\_Types](https://en.wikipedia.org/wiki/802.11_Frame_Types)

### QUESTION 8

In which way does a spine-and-leaf architecture allow for scalability in a network when additional access ports are required?

- A. A spine switch and a leaf switch can be added with redundant connections between them.
- B. A spine switch can be added with at least 40 GB uplinks.
- C. A leaf switch can be added with connections to every spine switch.
- D. A leaf switch can be added with a single connection to a core spine switch.

**Correct Answer:** C

**Section:** Network Fundamentals

**Explanation**

**Explanation/Reference:**

### QUESTION 9

Which statement identifies the functionality of virtual machines?

- A. The hypervisor communicates on Layer 3 without the need for additional resources.
- B. Each hypervisor can support a single virtual machine and a single software switch.
- C. The hypervisor can virtual physical components including CPU, memory, and storage.
- D. Virtualized servers run most efficiently when they are physically connected to a switch that is separate from the hypervisor.

**Correct Answer:** C

**Section:** Network Fundamentals

**Explanation**

**Explanation/Reference:**

### QUESTION 10

Which command automatically generates an IPv6 address from a specified IPv6 prefix and MAC address of an interface?

- A. `ipv6 address dhcp`
- B. `ipv6 address 2001:DB8:5:112::/64 eui-64`
- C. `ipv6 address autoconfig`
- D. `ipv6 address 2001:DB8:5:112::2/64 link-local`

**Correct Answer:** C

**Section:** Network Fundamentals

**Explanation**

**Explanation/Reference:**

### QUESTION 11

When configuring IPv6 on an interface, which two IPv6 multicast groups are joined? (Choose two.)

- A. `2000::/3`
- B. `2002::5`
- C. `FC00::/7`

- D. FF02::1
- E. FF02::2

**Correct Answer:** DE  
**Section:** Network Fundamentals  
**Explanation**

**Explanation/Reference:**

Reference:

<https://www.cisco.com/c/en/us/td/docs/ios-xml/ios/ipv6/configuration/xr-3s/ipv6-xr-36s-book/ipv6-multicast.html>

**QUESTION 12**  
DRAG DROP

```
[root#HostTime =]# ip route
default via 192.168.1.193 dev eth1 proto static
192.168.1.0/26 dev sth1 proto kernel scope link src 192.168.1.200 metric 1

[root#HostTime =]# ip addr show eth1
eth1:mtu 1500 qdisc pfifo_fast qlen 1000
    link/ether 00:0c:22:83:79:a3 brd ff:ff:ff:ff:ff:ff
    inet 192.168.1.200/26 hrd 192.168.1.255 scope global eth1
    inet6 fe80::20c::29ff:fe89:79b3/64 scope link
    valid_lft forever preferred_lft forever
```

Refer to the exhibit. Drag and drop the networking parameters from the left onto the correct values on the right.

**Select and Place:**

**Answer Area**

default gateway	00:0c:22
host IP address	00:0c:22:83:79:a3
NIC MAC address	192.168.1.193
NIC vendor OUI	192.168.1.200
subnet mask	255.255.255.192

**Correct Answer:**

## Answer Area

default gateway	NIC vendor OUI
host IP address	NIC MAC address
NIC MAC address	default gateway
NIC vendor OUI	host IP address
subnet mask	subnet mask

### Section: Network Fundamentals

#### Explanation

#### Explanation/Reference:

#### QUESTION 13

What is the default behavior of a Layer 2 switch when a frame with an unknown destination MAC address is received?

- A. The Layer 2 switch forwards the packet and adds the destination MAC address to its MAC address table.
- B. The Layer 2 switch sends a copy of a packet to CPU for destination MAC address learning.
- C. The Layer 2 switch floods packets to all ports except the receiving port in the given VLAN.
- D. The Layer 2 switch drops the received frame.

**Correct Answer: C**

### Section: Network Fundamentals

#### Explanation

#### Explanation/Reference:

#### QUESTION 14

An engineer must configure a /30 subnet between two routes. Which usable IP address and subnet mask combination meets this criteria?

- A. **interface e0/0**  
**description to HQ-A370:98968**  
**ip address 10.2.1.3 255.255.255.252**
- B. **interface e0/0**  
**description to HQ-A370:98968**  
**ip address 192.168.1.1 255.255.255.248**
- C. **interface e0/0**  
**description to HQ-A370:98968**  
**ip address 172.16.1.4 255.255.255.248**
- D. **interface e0/0**

**description to HQ-A370:98968**  
**ip address 209.165.201.2 225.255.255.252**

**Correct Answer: D**  
**Section: Network Fundamentals**  
**Explanation**

**Explanation/Reference:**

**QUESTION 15**

Which network allows devices to communicate without the need to access the Internet?

- A. 172.9.0.0/16
- B. 172.28.0.0/16
- C. 192.0.0.0/8
- D. 209.165.201.0/24

**Correct Answer: B**  
**Section: Network Fundamentals**  
**Explanation**

**Explanation/Reference:**

**QUESTION 16**

```
Router(config)#interface GigabitEthernet 1/0/1
Router(config-if)#ip address 192.168.16.143 255.255.255.240
Bad mask /28 for address 192.168.16.143
```

Refer to the exhibit. Which statement explains the configuration error message that is received?

- A. It belongs to a private IP address range.
- B. The router does not support /28 mask.
- C. It is a network IP address.
- D. It is a broadcast IP address.

**Correct Answer: D**  
**Section: Network Fundamentals**  
**Explanation**

**Explanation/Reference:**

**QUESTION 17**

Which IPv6 address type communication between subnets and cannot route on the Internet?

- A. link-local
- B. unique local
- C. multicast
- D. global unicast

**Correct Answer: B**  
**Section: Network Fundamentals**  
**Explanation**

**Explanation/Reference:**

**QUESTION 18**

Which IPv6 address block sends packets to a group address rather than a single address?

- A. 2000::/3
- B. FC00::/7
- C. FE80::/10
- D. FF00::/8

**Correct Answer: D**  
**Section: Network Fundamentals**  
**Explanation**

**Explanation/Reference:**

**QUESTION 19**

What are two reasons that cause late collisions to increment on an Ethernet interface? (Choose two.)

- A. when Carrier Sense Multiple Access/Collision Detection is used
- B. when one side of the connection is configured for half-duplex
- C. when the sending device waits 15 seconds before sending the frame again
- D. when a collision occurs after the 32nd byte of a frame has been transmitted
- E. when the cable length limits are exceeded

**Correct Answer: AE**  
**Section: Network Fundamentals**  
**Explanation**

**Explanation/Reference:**

**QUESTION 20**

What is a benefit of using a Cisco Wireless LAN Controller?

- A. It eliminates the need to configure each access point individually.
- B. Central AP management requires more complex configurations.
- C. Unique SSIDs cannot use the same authentication method.
- D. It supports autonomous and lightweight APs.

**Correct Answer: A**  
**Section: Network Fundamentals**  
**Explanation**

**Explanation/Reference:**

**QUESTION 21**

Which action is taken by switch port enabled for PoE power classification override?

- A. If a monitored port exceeds the maximum administrative value for power, the port is shutdown and err-disabled.
- B. When a powered device begins drawing power from a PoE switch port, a syslog message is generated.
- C. As power usage on a PoE switch port is checked, data flow to the connected device is temporarily paused.
- D. If a switch determines that a device is using less than the minimum configured power, it assumes the device has failed and disconnects it.

**Correct Answer:** A

**Section:** Network Fundamentals

**Explanation**

**Explanation/Reference:**

Reference: [https://www.cisco.com/c/en/us/td/docs/switches/lan/catalyst6500/ios/12-2SX/configuration/guide/book/power\\_over\\_ethernet.pdf](https://www.cisco.com/c/en/us/td/docs/switches/lan/catalyst6500/ios/12-2SX/configuration/guide/book/power_over_ethernet.pdf)

#### QUESTION 22

Which statement about Link Aggregation when implementing on a Cisco Wireless LAN Controller is true?

- A. The EtherChannel must be configured in "mode active".
- B. When enabled, the WLC bandwidth drops to 500 Mbps.
- C. To pass client traffic, two or more ports must be configured.
- D. One functional physical port is needed to pass client traffic.

**Correct Answer:** D

**Section:** Network Access

**Explanation**

**Explanation/Reference:**

Reference: [https://www.cisco.com/c/en/us/td/docs/wireless/controller/8-2/config-guide/b\\_cg82/b\\_cg82\\_chapter\\_010101011.html](https://www.cisco.com/c/en/us/td/docs/wireless/controller/8-2/config-guide/b_cg82/b_cg82_chapter_010101011.html)

#### QUESTION 23

Which two conditions must be met before SSH can operate normally on a Cisco IOS switch? (Choose two.)

- A. IP routing must be enabled on the switch.
- B. A console password must be configured on the switch.
- C. Telnet must be disabled on the switch.
- D. The switch must be running a k9 (crypto) IOS image.
- E. The **ip domain-name** command must be configured on the switch.

**Correct Answer:** DE

**Section:** Network Access

**Explanation**

**Explanation/Reference:**

Reference: <https://www.cisco.com/c/en/us/support/docs/security-vpn/secure-shell-ssh/4145-ssh.html>

#### QUESTION 24

```

Atlanta#conf t
Enter configuration commands, one per line. End with CNTL/Z.
Atlanta(config)#aaa new-model
Atlanta(config)#aaa authentication login default local
Atlanta(config)#line vty 0 4
Atlanta(config-line)#login authentication default
Atlanta(config-line)#exit
Atlanta(config)#username ciscoadmin password adminadmin123
Atlanta(config)#username ciscoadmin privilege 15
Atlanta(config)#enable password cisco123
Atlanta(config)#enable secret testing1234
Atlanta(config)#end

```

Refer to the exhibit. Which password must an engineer use to enter the enable mode?

- A. adminadmin123
- B. cisco123
- C. default
- D. testing1234

**Correct Answer: D**

**Section: Network Access**

**Explanation**

**Explanation/Reference:**

**QUESTION 25**

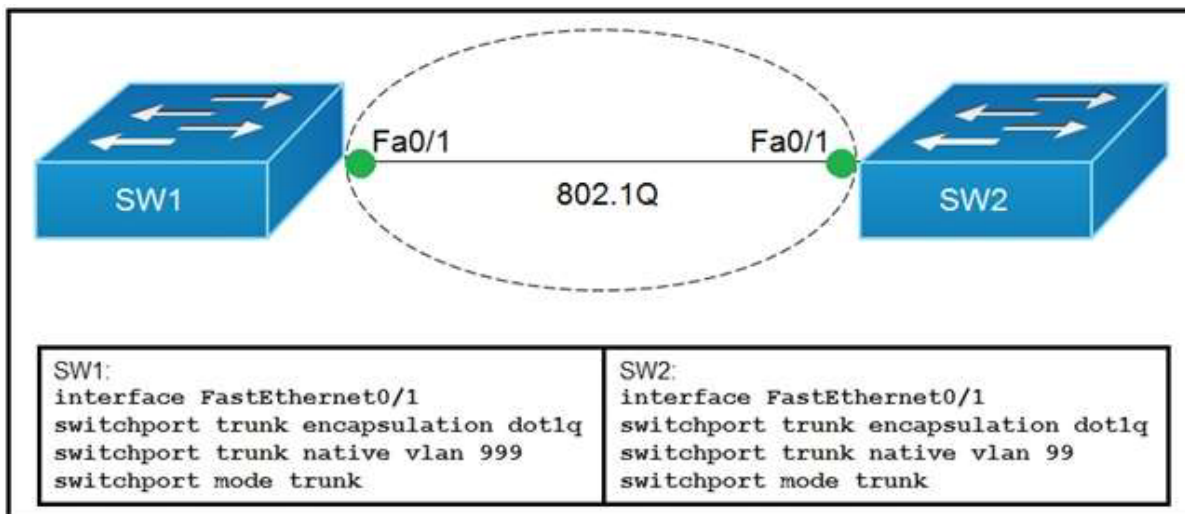

Refer to the exhibit. Which action do the switches take on the trunk link?

- A. The trunk does not form, and the ports go into an err-disabled status.
- B. The trunk forms, but the mismatched native VLANs are merged into a single broadcast domain.
- C. The trunk forms, but VLAN 99 and VLAN 999 are in a shutdown state.
- D. The trunk does not form, but VLAN 99 and VLAN 999 are allowed to traverse the link.

**Correct Answer:** B  
**Section:** Network Access  
**Explanation**

**Explanation/Reference:**

#### QUESTION 26

What is the primary effect of the **spanning-tree portfast** command?

- A. It immediately enables the port in the listening state.
- B. It immediately puts the port into the forwarding state when the switch is reloaded.
- C. It enabled BPDU messages.
- D. It minimizes spanning-tree convergence time.

**Correct Answer:** D  
**Section:** Network Access  
**Explanation**

**Explanation/Reference:**

Reference: [https://www.cisco.com/c/en/us/td/docs/switches/lan/catalyst3560/software/release/12-2\\_55\\_se/configuration/guide/3560\\_scg/swstpopt.html](https://www.cisco.com/c/en/us/td/docs/switches/lan/catalyst3560/software/release/12-2_55_se/configuration/guide/3560_scg/swstpopt.html)

#### QUESTION 27

Which result occurs when PortFast is enabled on an interface that is connected to another switch?

- A. Root port choice and spanning tree recalculation are accelerated when a switch link goes down.
- B. After spanning tree converges, PortFast shuts down any port that receives BPDUs.
- C. VTP is allowed to propagate VLAN configuration information from switch to switch automatically.
- D. Spanning tree may fail to detect a switching loop in the network that causes broadcast storms.

**Correct Answer:** D  
**Section:** Network Access  
**Explanation**

**Explanation/Reference:**

#### QUESTION 28

Which QoS Profile is selected in the GUI when configuring a voice over WLAN deployment?

- A. Platinum
- B. Bronze
- C. Gold
- D. Silver

**Correct Answer:** A  
**Section:** Network Access  
**Explanation**

**Explanation/Reference:**

Reference: <https://www.cisco.com/c/en/us/support/docs/wireless-mobility/wireless-lan-wlan/81831-qos-wlc-lap.html>

#### QUESTION 29

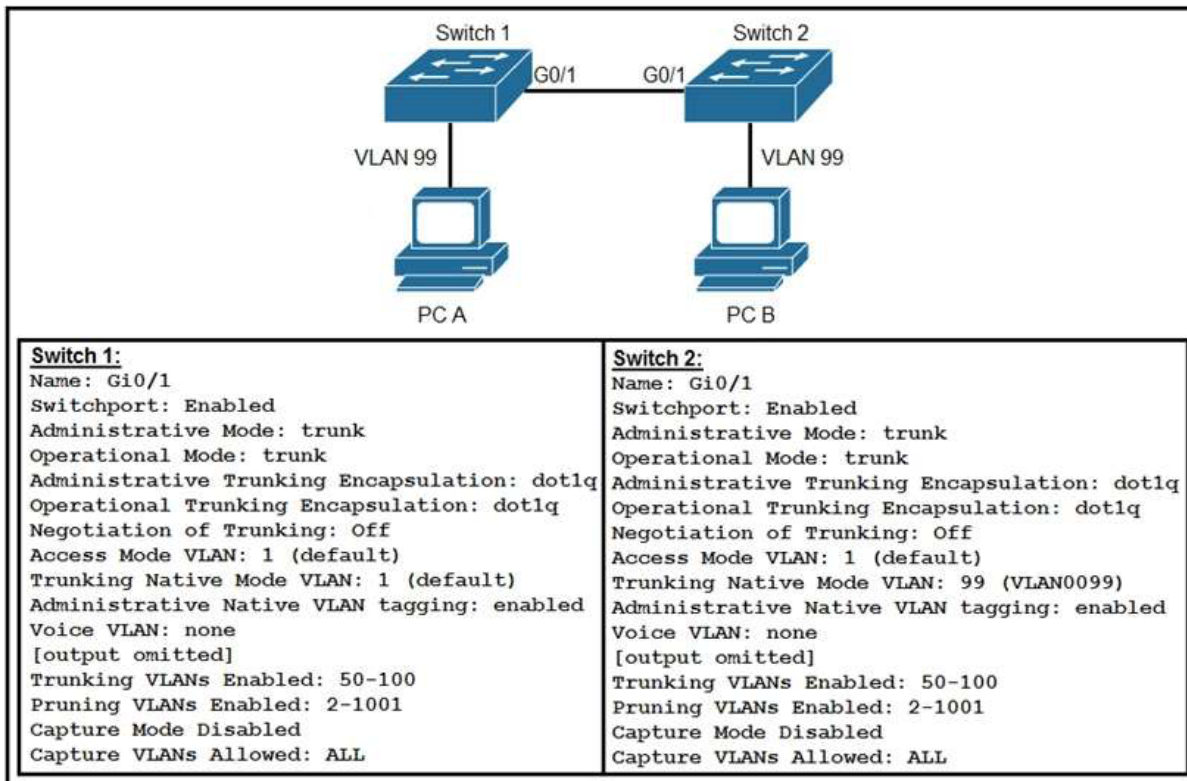

Refer to the exhibit. After the switch configuration, the ping test fails between PC A and PC B. Based on the output for switch 1, which error must be corrected?

- A. The PCs are in the incorrect VLAN.
- B. All VLANs are not enabled on the trunk.
- C. Access mode is configured on the switch ports.
- D. There is a native VLAN mismatch.

**Correct Answer: D**  
**Section: Network Access**  
**Explanation**

**Explanation/Reference:**

**QUESTION 30**  
**DRAG DROP**

Drag and drop the WLAN components from the left onto the correct description on the right.

**Select and Place:**

### Answer Area

access point	device that manages access points
virtual interface	device that provides Wi-Fi devices with a connection to a wired network
dynamic interface	used for out of band management of a WLC
service port	used to support mobility management of the WLC
wireless LAN controller	applied to the WLAN for wireless client communication

Correct Answer:

### Answer Area

access point	wireless LAN controller
virtual interface	access point
dynamic interface	service port
service port	virtual interface
wireless LAN controller	dynamic interface

Section: Network Access  
Explanation

Explanation/Reference:

#### QUESTION 31

Which unified access point mode continues to serve wireless clients after losing connectivity to the Cisco Wireless LAN Controller?

- A. local
- B. mesh
- C. flexconnect
- D. sniffer

Correct Answer: C  
Section: Network Access

## Explanation

### Explanation/Reference:

Reference: [https://www.cisco.com/c/en/us/td/docs/wireless/controller/8-5/config-guide/b\\_cg85/flexconnect.html](https://www.cisco.com/c/en/us/td/docs/wireless/controller/8-5/config-guide/b_cg85/flexconnect.html)

### QUESTION 32

Router#	Capability Codes: R - Router, T - Trans Bridge, B - Source Route Bridge S - Switch, H - Host, I - IGMP, r - Repeater, P - Phone, D - Remote, C - CVTA, M - Two-port Mac Relay				
Device ID	Local Interface	Holdtime	Capability	Platform	Port ID
10.1.1.2	Gig 37/3	176	RI	CPT 600	Gig 36/41
10.1.1.2	Gig 37/1	174	RI	CPT 600	Gig 36/43
10.1.1.2	Gig 36/41	134	RI	CPT 600	Gig 37/3
10.1.1.2	Gig 36/43	134	RI	CPT 600	Gig 37/1
10.1.1.2	Ten 3/2	132	RI	CPT 600	Ten 4/2
10.1.1.2	Ten 4/2	174	RI	CPT 600	Ten 3/2

Refer to the exhibit. Which command provides this output?

- A. **show ip route**
- B. **show cdp neighbor**
- C. **show ip interface**
- D. **show interface**

**Correct Answer: B**

**Section: Network Access**

**Explanation**

**Explanation/Reference:**

### QUESTION 33

Which mode must be used to configure EtherChannel between two switches without using a negotiation protocol?

- A. active
- B. on
- C. auto
- D. desirable

**Correct Answer: B**

**Section: Network Access**

**Explanation**

**Explanation/Reference:**

### QUESTION 34

Which mode allows access points to be managed by Cisco Wireless LAN Controllers?

- A. bridge
- B. lightweight
- C. mobility express
- D. autonomous

**Correct Answer:** B  
**Section:** Network Access  
**Explanation**

**Explanation/Reference:**

**QUESTION 35**

Which two values or settings must be entered when configuring a new WLAN in the Cisco Wireless LAN Controller GUI? (Choose two.)

- A. QoS settings
- B. IP address of one or more access points
- C. SSID
- D. profile name
- E. management interface settings

**Correct Answer:** CD  
**Section:** Network Access  
**Explanation**

**Explanation/Reference:**

**QUESTION 36**

Which command is used to specify the delay time in seconds for LLDP to initialize on any interface?

- A. lldp timer
- B. lldp tlv-select
- C. lldp reinit
- D. lldp holdtime

**Correct Answer:** C  
**Section:** Network Access  
**Explanation**

**Explanation/Reference:**

Reference: [https://www.cisco.com/c/en/us/td/docs/switches/lan/catalyst2960/software/release/12-2\\_37\\_ey/configuration/guide/scg/swlldp.pdf](https://www.cisco.com/c/en/us/td/docs/switches/lan/catalyst2960/software/release/12-2_37_ey/configuration/guide/scg/swlldp.pdf)

**QUESTION 37**

```

SW2
vtp domain cisco
vtp mode transparent
vtp password ciscotest
interface fastethernet0/1
  description connection to sw1
  switchport mode trunk
  switchport trunk encapsulation dot1q

```

Refer to the exhibit. How does SW2 interact with other switches in this VTP domain?

- A. It transmits and processes VTP updates from any VTP clients on the network on its trunk ports.
- B. It processes VTP updates from any VTP clients on the network on its access ports.
- C. It receives updates from all VTP servers and forwards all locally configured VLANs out all trunk ports.
- D. It forwards only the VTP advertisements that it receives on its trunk ports.

**Correct Answer: D**  
**Section: Network Access**  
**Explanation**

**Explanation/Reference:**  
 Reference: <https://www.cisco.com/c/en/us/support/docs/lan-switching/vtp/10558-21.html>

**QUESTION 38**

```

SW1#sh lacp neighbor
Flags: S - Device is requesting Slow LACPDUs
      F - Device is requesting Fast LACPDUs
      A - Device is in Active mode      P - Device is in Passive mode

Channel group 35 neighbors

Partner's information:

Port      LACP port      Admin Oper  Port  Port
Flags Priority  Dev ID      Age key  Key  Number State
Et1/0 SP    32768 aabb.cc80.7000 8s 0x0 0x23 0x101 0x3C
Et1/1 SP    32768 aabb.cc80.7000 8s 0x0 0x23 0x102 0x3C

```

Refer to the exhibit. Based on the LACP neighbor status, in which mode is the SW1 port channel configured?

- A. mode on
- B. active
- C. passive
- D. auto

**Correct Answer: B**  
**Section: Network Access**  
**Explanation**

**Explanation/Reference:**

**QUESTION 39**

Two switches are connected and using Cisco Dynamic Trunking Protocol. SW1 is set to Dynamic Auto and SW2 is set to Dynamic Desirable. What is the result of this configuration?

- A. The link becomes an access port.
- B. The link is in an error disabled state.
- C. The link is in a down state.
- D. The link becomes a trunk port.

**Correct Answer:** D

**Section:** Network Access

**Explanation**

**Explanation/Reference:**

**QUESTION 40**

A Cisco IP phone receives untagged data traffic from an attached PC. Which action is taken by the phone?

- A. It drops the traffic.
- B. It allows the traffic to pass through unchanged.
- C. It tags the traffic with the native VLAN.
- D. It tags the traffic with the default VLAN.

**Correct Answer:** B

**Section:** Network Access

**Explanation**

**Explanation/Reference:**

Reference: [https://www.cisco.com/c/en/us/td/docs/switches/lan/catalyst2960x/software/15-0\\_2\\_EX/vlan/configuration\\_guide/b\\_vlan\\_152ex\\_2960-x\\_cg/b\\_vlan\\_152ex\\_2960-x\\_cg\\_chapter\\_0110.pdf](https://www.cisco.com/c/en/us/td/docs/switches/lan/catalyst2960x/software/15-0_2_EX/vlan/configuration_guide/b_vlan_152ex_2960-x_cg/b_vlan_152ex_2960-x_cg_chapter_0110.pdf)

**QUESTION 41**

Which design element is a best practice when deploying an 802.11b wireless infrastructure?

- A. allocation nonoverlapping channels to access points that are in close physical proximity to one another
- B. disabling TCP so that access points can negotiate signal levels with their attached wireless devices
- C. configuring access points to provide clients with a maximum of 5 Mbps
- D. setting the maximum data rate to 54 Mbps on the Cisco Wireless LAN Controller

**Correct Answer:** A

**Section:** Network Access

**Explanation**

**Explanation/Reference:**

**QUESTION 42**

```
R1#show ip interface brief
```

Interface	IP-Address	OK?	Method	Status	Protocol
FastEthernet0/0	unassigned	YES	NVRAM	administratively down	down
GigabitEthernet1/0	192.168.0.1	YES	NVRAM	up	up
GigabitEthernet2/0	10.10.1.10	YES	manual	up	up
GigabitEthernet3/0	10.10.10.20	YES	manual	up	up
GigabitEthernet4/0	unassigned	YES	NVRAM	administratively down	down
Loopback0	172.16.15.10	YES	manual		

Refer to the exhibit. What does router R1 use as its OSPF router-ID?

- A. 10.10.1.10
- B. 10.10.10.20
- C. 172.16.15.10
- D. 192.168.0.1

**Correct Answer: C**

**Section: IP Connectivity**

**Explanation**

**Explanation/Reference:**

#### QUESTION 43

When OSPF learns multiple paths to a network, how does it select a route?

- A. For each existing interface, it adds the metric from the source router to the destination to calculate the route with the lowest bandwidth.
- B. It counts the number of hops between the source router and the destination to determine the route with the lowest metric.
- C. It divides a reference bandwidth of 100 Mbps by the actual bandwidth of the exiting interface to calculate the route with the lowest cost.
- D. It multiplies the active K values by 256 to calculate the route with the lowest metric.

**Correct Answer: C**

**Section: IP Connectivity**

**Explanation**

**Explanation/Reference:**

#### QUESTION 44

When a floating static route is configured, which action ensures that the backup route is used when the primary route fails?

- A. The administrative distance must be higher on the primary route so that the backup route becomes secondary.
- B. The **default-information originate** command must be configured for the route to be installed into the routing table.
- C. The floating static route must have a lower administrative distance than the primary route so it is used as a backup.
- D. The floating static route must have a higher administrative distance than the primary route so it is used as a backup.

**Correct Answer: D**

**Section: IP Connectivity**

## Explanation

Explanation/Reference:

### QUESTION 45

```
Designated Router (ID) 10.11.11.11, Interface address 10.10.10.1
Backup Designated router (ID) 10.3.3.3, Interface address 10.10.10.3
Timer intervals configured, Hello 10, Dead 40, Wait 40, Retransmit 5
oob-resync timeout 40
Hello due in 00:00:08
Supports Link-local Signaling (LLS)
Cisco NSF helper support enabled
IETF NSF helper support enabled
Index 1/1/1, flood queue length 0
Next 0x0(0)/0x0(0)/0x0(0)
Last flood scan length is 1, maximum is 6
Last flood scan time is 0 msec, maximum is 1 msec
Neighbor Count is 3, Adjacent neighbor count is 3
Adjacent with neighbor 10.1.1.4
Adjacent with neighbor 10.2.2.2
Adjacent with neighbor 10.3.3.3 (Backup Designated Router)
Suppress hello for 0 neighbor(s)
```

Refer to the exhibit. The **show ip ospf interface** command has been executed on R1. How is OSPF configured?

- A. A point-to-point network type is configured.
- B. The interface is not participating in OSPF.
- C. The default Hello and Dead timers are in use.
- D. There are six OSPF neighbors on this interface.

**Correct Answer: C**

**Section: IP Connectivity**

**Explanation**

**Explanation/Reference:**

Reference: <https://www.cisco.com/c/en/us/support/docs/ip/open-shortest-path-first-ospf/13689-17.html>

### QUESTION 46

A user configured OSPF and advertised the Gigabit Ethernet interface in OSPF. By default, which type of OSPF network does this interface belong to?

- A. point-to-multipoint
- B. point-to-point
- C. broadcast
- D. nonbroadcast

**Correct Answer: C**

**Section: IP Connectivity**  
**Explanation**

**Explanation/Reference:**

**QUESTION 47**

Which attribute does a router use to select the best path when two or more different routes to the same destination exist from two different routing protocols?

- A. dual algorithm
- B. metric
- C. administrative distance
- D. hop count

**Correct Answer: C**

**Section: IP Connectivity**  
**Explanation**

**Explanation/Reference:**

**QUESTION 48**

Router A learns the same route from two different neighbors; one of the neighbor routers is an OSPF neighbor, and the other is an EIGRP neighbor.

What is the administrative distance of the route that will be installed in the routing table?

- A. 20
- B. 90
- C. 110
- D. 115

**Correct Answer: B**

**Section: IP Connectivity**  
**Explanation**

**Explanation/Reference:**

**QUESTION 49**

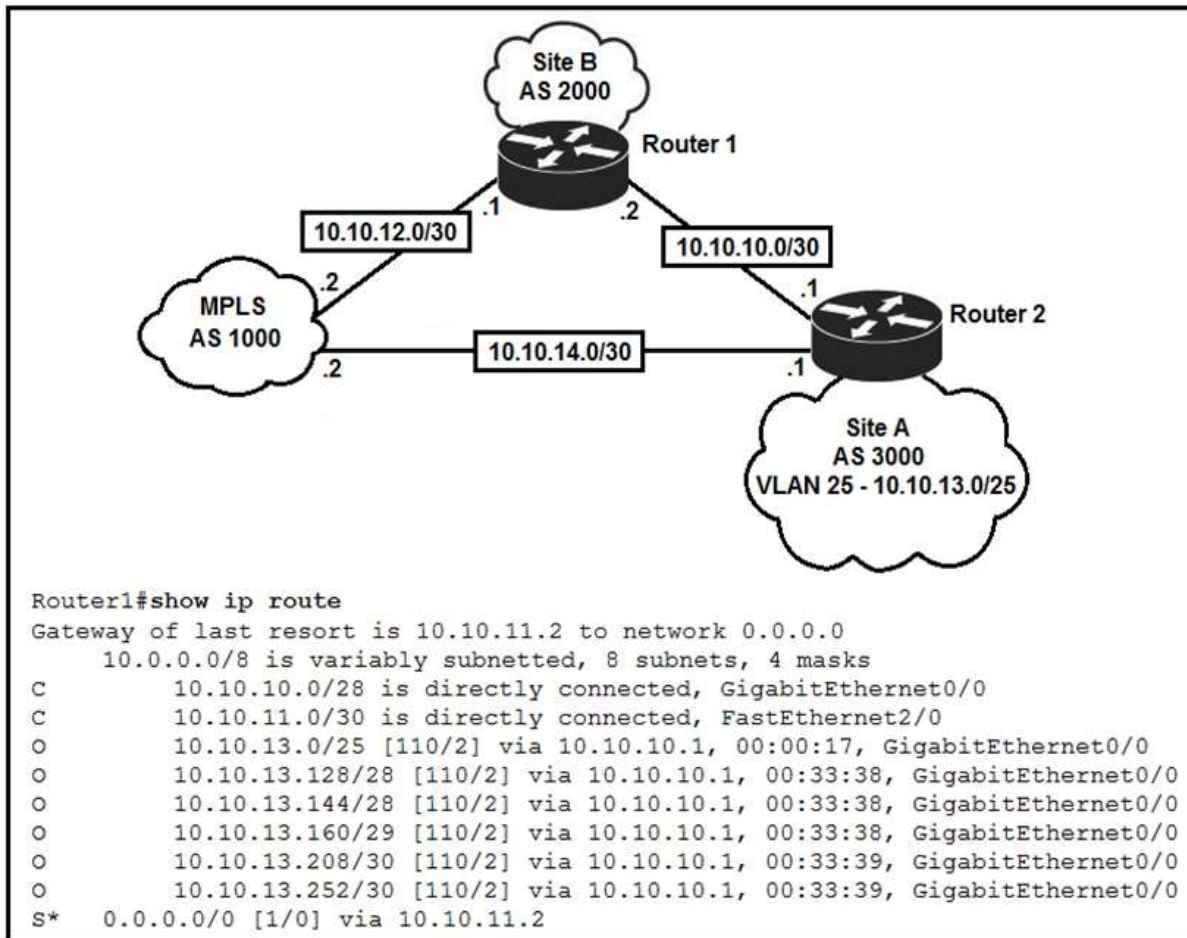

Refer to the exhibit. An engineer is bringing up a new circuit to the MPLS provider on the Gi0/1 interface of Router 1. The new circuit uses eBGP and learns the route to VLAN25 from the BGP path.

What is the expected behavior for the traffic flow for route 10.10.13.0/25?

- A. Traffic to 10.10.13.0/25 is load balanced out of multiple interfaces.
- B. Traffic to 10.10.13.0/25 is asymmetrical.
- C. Route 10.10.13.0/25 is updated in the routing table as being learned from interface Gi0/1.
- D. Route 10.10.13.0/25 learned via the Gi0/0 interface remains in the routing table.

**Correct Answer: D**  
**Section: IP Connectivity**  
**Explanation**

**Explanation/Reference:**

**QUESTION 50**

Which two actions influence the EIGRP route selection process? (Choose two.)

- A. The advertised distance is calculated by a downstream neighbor to inform the local router of the bandwidth on the link.
- B. The router calculates the feasible distance of all paths to the destination route.
- C. The router must use the advertised distance as the metric for any given route.

- D. The router calculates the best backup path to the destination route and assigns it as the feasible successor.
- E. The router calculates the reported distance by multiplying the delay on the exiting interface by 256.

**Correct Answer:** BD  
**Section:** IP Connectivity  
**Explanation**

**Explanation/Reference:**

**QUESTION 51**

```

Roter2#show ip route
Gateway of last resort is not set

    10.0.0.0/8 is variably subnetted, 4 subnets, 2 masks
C       10.10.10.8/30 is directly connected, FastEthernet0/2
C       10.10.10.12/30 is directly connected, FastEthernet0/1
O       10.10.13.0/25 [110/11] via 10.10.10.9, 00:00:03, FastEthernet0/2
        [110/11] via 10.10.10.13, 00:00:03, FastEthernet0/1
C       10.10.10.4/30 is directly connected, FastEthernet0/2
  
```

Refer to the exhibit. If OSPF is running on this network, how does Router2 handle traffic from Site B to 10.10.13.128/25 at Site A?

- A. It sends packets out of interface Fa0/1 only.
- B. It sends packets out of interface Fa0/2 only.
- C. It load-balances traffic out of Fa0/1 and Fa0/2.
- D. It cannot send packets to 10.10.13.128/25.

**Correct Answer:** D  
**Section:** IP Connectivity  
**Explanation**

**Explanation/Reference:**

**QUESTION 52**

Which two outcomes are predictable behaviors for HSRP? (Choose two.)

- A. The two routers negotiate one router as the active router and the other as the standby router.
- B. The two routers share the same interface IP address, and default gateway traffic is load-balanced between them.

- C. The two routers synchronize configurations to provide consistent packet forwarding.
- D. Each router has a different IP address, both routers act as the default gateway on the LAN, and traffic is load-balanced between them.
- E. The two routers share a virtual IP address that is used as the default gateway for devices on the LAN.

**Correct Answer:** AE  
**Section:** IP Connectivity  
**Explanation**

**Explanation/Reference:**

**QUESTION 53**

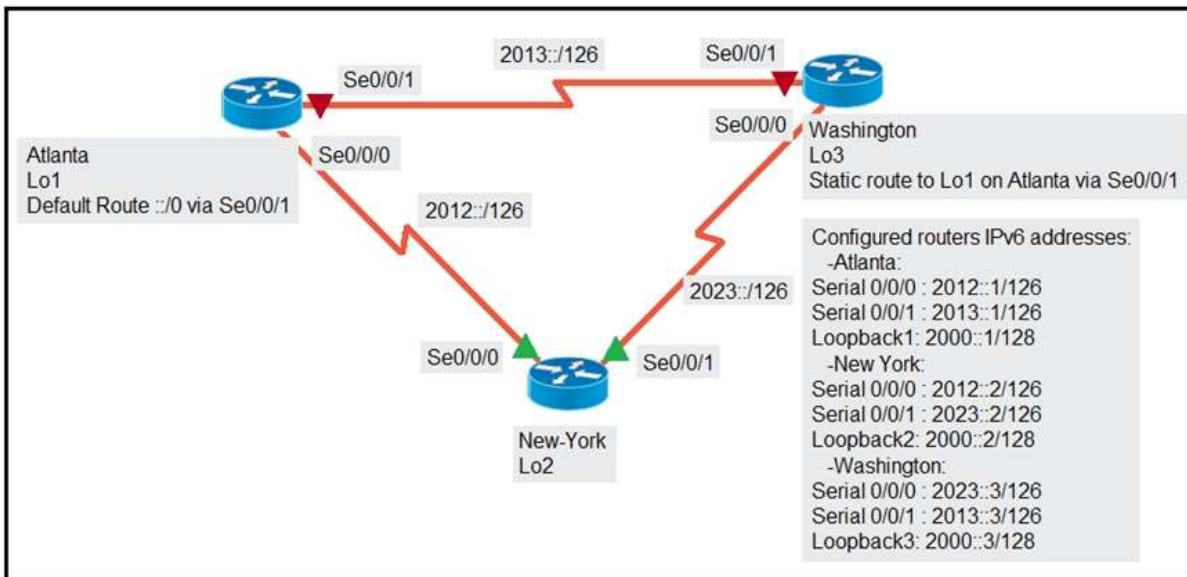

Refer to the exhibit. An engineer is configuring the New York router to reach the Lo1 interface of the Atlanta router using interface Se0/0/0 as the primary path. Which two commands must be configured on the New York router so that it can reach the Lo1 interface of the Atlanta router via Washington when the link between New York and Atlanta goes down? (Choose two.)

- A. **ipv6 route 2000::1/128 2012::1**
- B. **ipv6 route 2000::1/128 2012::1 5**
- C. **ipv6 route 2000::1/128 2012::2**
- D. **ipv6 route 2000::1/128 2023::2 5**
- E. **ipv6 route 2000::1/128 2023::3 5**

**Correct Answer:** AE  
**Section:** IP Connectivity  
**Explanation**

**Explanation/Reference:**

**QUESTION 54**

How does HSRP provide first hop redundancy?

- A. It load-balances Layer 2 traffic along the path by flooding traffic out all interfaces configured with the same VLAN.

- B. It uses a shared virtual MAC and a virtual IP address to a group of routers that serve as the default gateway for hosts on a LAN.
- C. It forwards multiple packets to the same destination over different routed links in the data path.
- D. It load-balances traffic by assigning the same metric value to more than one route to the same destination in the IP routing table.

**Correct Answer:** B  
**Section:** IP Connectivity  
**Explanation**

**Explanation/Reference:**

**QUESTION 55**  
 DRAG DROP

A network engineer is configuring an OSPFv2 neighbor adjacency. Drag and drop the parameters from the left onto their required categories on the right. No all parameters are used.

**Select and Place:**

**Answer Area**

area ID	must match
IP address	
netmask	
OSPF process ID	must be unique
router ID	
timers	

**Correct Answer:**

## Answer Area

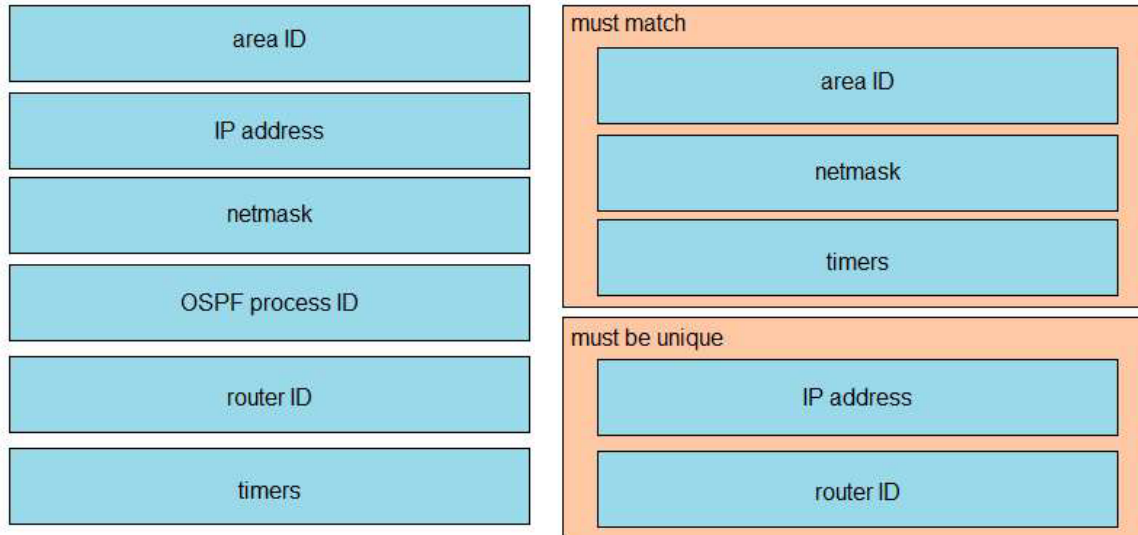

### Section: IP Connectivity Explanation

Explanation/Reference:

#### QUESTION 56

R1 has learned route 192.168.12.0/24 via IS-IS, OSPF, RIP, and Internal EIGRP. Under normal operating conditions, which routing protocol is installed in the routing table?

- A. IS-IS
- B. Internal EIGRP
- C. RIP
- D. OSPF

**Correct Answer:** B  
**Section:** IP Connectivity  
**Explanation**

Explanation/Reference:

#### QUESTION 57

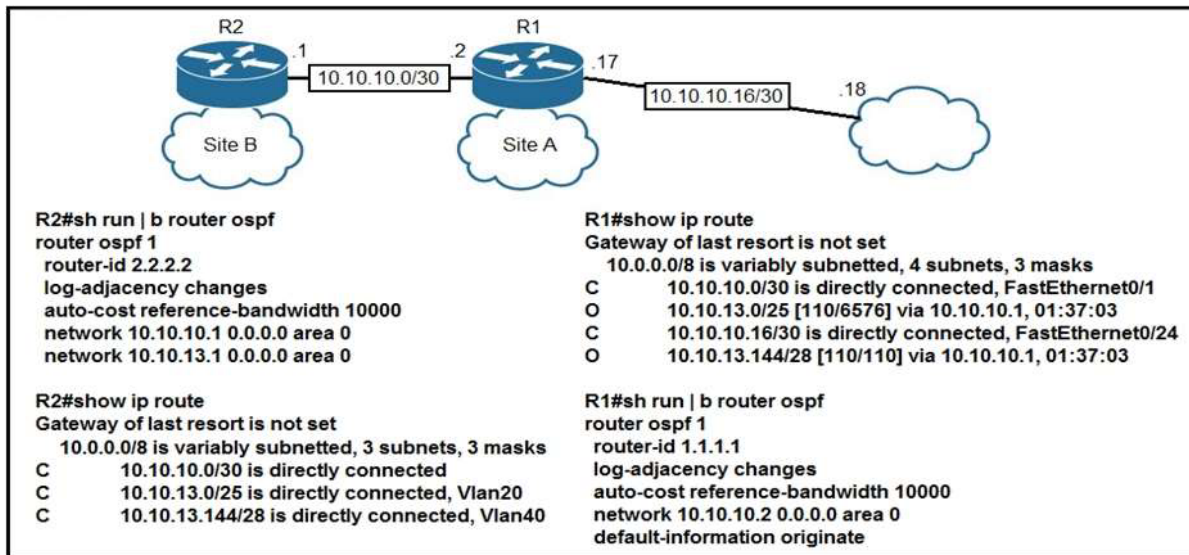

Refer to the exhibit. The **default-information originate** command is configured under the R1 OSPF configuration. After testing, workstations on VLAN 20 at Site B cannot reach a DNS server on the Internet.

Which action corrects the configuration issue?

- A. Add the **default-information originate** command on R2.
- B. Add the **always** keyword to the **default-information originate** command on R1.
- C. Configure the **ip route 0.0.0.0 0.0.0.0 10.10.10.18** command on R1.
- D. Configure the **ip route 0.0.0.0 0.0.0.0 10.10.10.2** command on R2.

**Correct Answer: C**  
**Section: IP Connectivity**  
**Explanation**

**Explanation/Reference:**

#### QUESTION 58

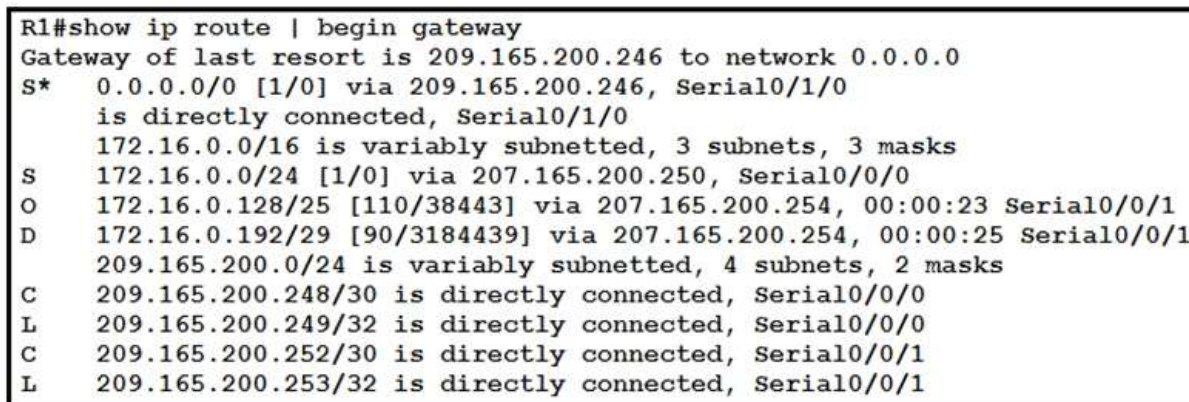

Refer to the exhibit. With which metric was the route to host 172.16.0.202 learned?

- A. 0
- B. 110

- C. 38443
- D. 3184439

**Correct Answer: C**  
**Section: IP Connectivity**  
**Explanation**

**Explanation/Reference:**

**QUESTION 59**

A user configured OSPF in a single area between two routers. A serial interface connecting R1 and R2 is running encapsulation PPP. By default, which OSPF network type is seen on this interface when the user types show ip ospf interface on R1 and R2?

- A. nonbroadcast
- B. point-to-point
- C. point-to-multipoint
- D. broadcast

**Correct Answer: B**  
**Section: IP Connectivity**  
**Explanation**

**Explanation/Reference:**

**QUESTION 60**

Which MAC address is recognized as a VRRP virtual address?

- A. 0000.5E00.010a
- B. 0005.3709.8968
- C. 0000.0C07.AC99
- D. 0007.C070.AB01

**Correct Answer: A**  
**Section: IP Connectivity**  
**Explanation**

**Explanation/Reference:**

**QUESTION 61**

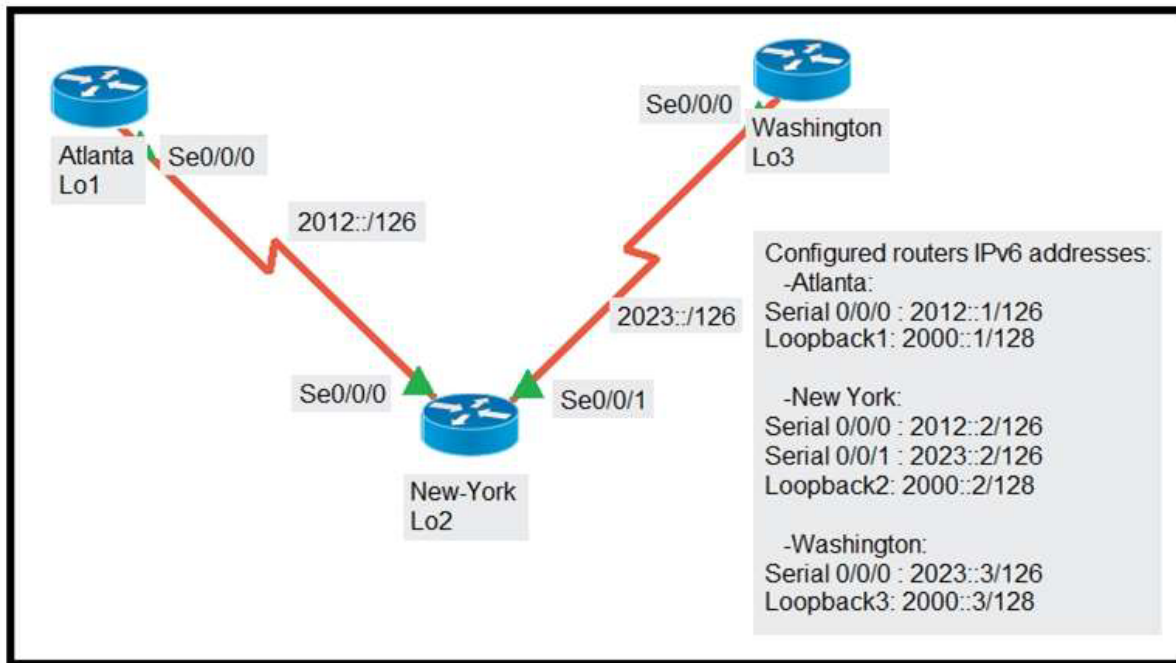

Refer to the exhibit. The New York router is configured with static routes pointing to the Atlanta and Washington sites.

Which two tasks must be performed so that the Serial0/0/0 interfaces on the Atlanta and Washington routers can reach one another? (Choose two.)

- A. Configure the **ipv6 route 2023::/126 2012::1** command on the Atlanta router.
- B. Configure the **ipv6 route 2012::/126 2023::2** command on the Washington router.
- C. Configure the **ipv6 route 2012::/126 2023::1** command on the Washington router.
- D. Configure the **ipv6 route 2023::/126 2012::2** command on the Atlanta router.
- E. Configure the **ipv6 route 2012::/126 s0/0/0** command on the Atlanta router.

**Correct Answer:** BD  
**Section:** IP Connectivity  
**Explanation**

**Explanation/Reference:**

**QUESTION 62**

A router running EIGRP has learned the same route from two different paths. Which parameter does the router use to select the best path?

- A. as-path
- B. administrative distance
- C. metric
- D. cost

**Correct Answer:** C  
**Section:** IP Connectivity  
**Explanation**

**Explanation/Reference:**

### QUESTION 63

An engineer configured an OSPF neighbor as a designated router. Which state verifies the designated router is in the proper mode?

- A. Init
- B. 2-way
- C. Exchange
- D. Full

**Correct Answer:** D

**Section:** IP Connectivity

**Explanation**

**Explanation/Reference:**

### QUESTION 64

```
R1# show ip route
D    192.168.16.0/26 [90/2679326] via 192.168.1.1
R    192.168.16.0/24 [120/3] via 192.168.1.2
O    192.168.16.0/21 [110/2] via 192.168.1.3
i Li 192.168.16.0/27 [115/30] via 192.168.1.4
```

Refer to the exhibit. Which route does R1 select for traffic that is destined to 192.168.16.2?

- A. 192.168.16.0/21
- B. 192.168.16.0/24
- C. 192.168.26.0/26
- D. 192.168.16.0/27

**Correct Answer:** D

**Section:** IP Connectivity

**Explanation**

**Explanation/Reference:**

### QUESTION 65

```
Gateway of last resort is 10.12.0.1 to network 0.0.0.0
O*K2 0.0.0.0/0 [110/1] via 10.12.0.1, 00:00:01, GigabitEthernet0/0
      10.0.0.0/8 is variably subnetted, 2 subnets, 2 masks
C    10.0.0.0/24 is directly connected, GigabitEthernet0/0
L    10.0.0.2/32 is directly connected, GigabitEthernet0/0
C    10.13.0.0/24 is directly connected, GigabitEthernet0/1
L    10.13.0.2/32 is directly connected, GigabitEthernet0/1
```

Refer to the exhibit. If configuring a static default route on the router with the **ip route 0.0.0.0 0.0.0.0 10.13.0.1**

**120** command, how does the router respond?

- A. It starts sending traffic without a specific matching entry in the routing table to GigabitEthernet0/1.
- B. It immediately replaces the existing OSPF route in the routing table with the newly configured static route.
- C. It starts load-balancing traffic between the two default routes.
- D. It ignores the new static route until the existing OSPF default route is removed.

**Correct Answer:** D  
**Section:** IP Connectivity  
**Explanation**

**Explanation/Reference:**

#### QUESTION 66

Which two actions are performed by the Weighted Random Early Detection mechanism? (Choose two.)

- A. It supports protocol discovery.
- B. It guarantees the delivery of high-priority packets.
- C. It can identify different flows with a high level of granularity.
- D. It can mitigate congestion by preventing the queue from filling up.
- E. It drops lower-priority packets before it drops higher-priority packets.

**Correct Answer:** DE  
**Section:** IP Services  
**Explanation**

**Explanation/Reference:**

#### QUESTION 67

```
R2#show ip nat translations
Pro  Inside global      Inside local      Outside local     Outside global
tcp  172.23.104.3:43268  10.4.4.4:43268   172.23.103.10:23  172.23.103.10:23
tcp  172.23.104.4:45507  10.4.4.5:45507   172.23.103.10:80  172.23.103.10:80
```

Refer to the exhibit. An engineer configured NAT translations and has verified that the configuration is correct. Which IP address is the source IP?

- A. 10.4.4.4
- B. 10.4.4.5
- C. 172.23.103.10
- D. 172.23.104.4

**Correct Answer:** C  
**Section:** IP Services  
**Explanation**

**Explanation/Reference:**

#### QUESTION 68

If a notice-level message is sent to a syslog server, which event has occurred?

- A. A network device has restarted.
- B. A debug operation is running.
- C. A routing instance has flapped.
- D. An ARP inspection has failed.

**Correct Answer:** C  
**Section:** IP Services  
**Explanation**

**Explanation/Reference:**

**QUESTION 69**  
DRAG DROP

Drag and drop the functions from the left onto the correct network components on the right.

**Select and Place:**

**Answer Area**

resolves web URLs to IP addresses

assigns a default gateway to a client

holds the TCP/IP settings to be distributed to the clients

stores a list of IP addresses mapped to names

assigns IP addresses to enabled clients

DHCP Server

DNS Server

**Correct Answer:**

## Answer Area

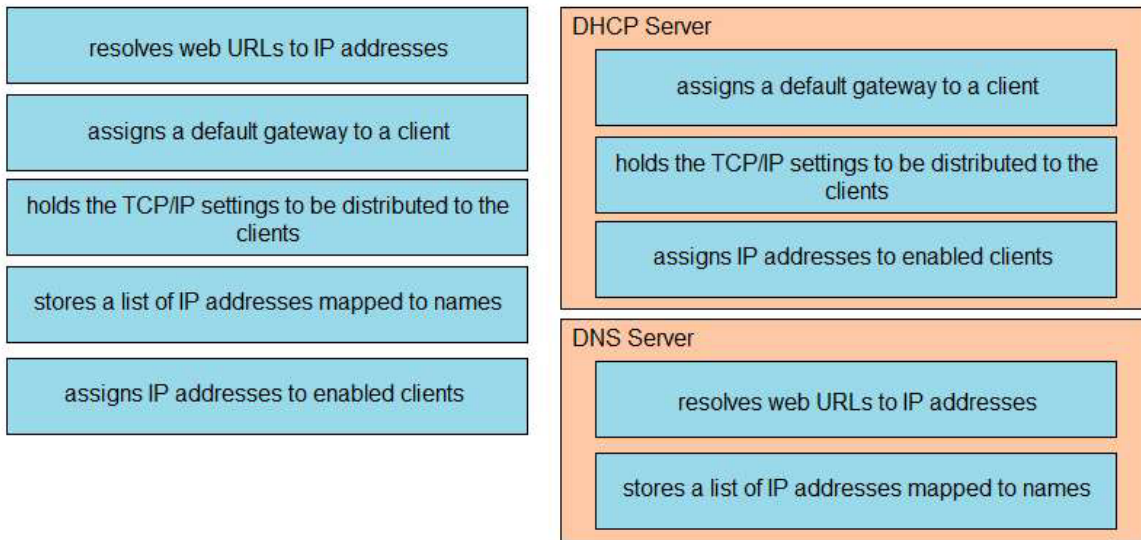

### Section: IP Services

#### Explanation

#### Explanation/Reference:

#### QUESTION 70

Which two tasks must be performed to configure NTP to a trusted server in client mode on a single network device? (Choose two.)

- A. Enable NTP authentication.
- B. Verify the time zone.
- C. Specify the IP address of the NTP server.
- D. Set the NTP server private key.
- E. Disable NTP broadcasts.

**Correct Answer:** CD

### Section: IP Services

#### Explanation

#### Explanation/Reference:

#### QUESTION 71

DRAG DROP

Drag and drop the network protocols from the left onto the correct transport services on the right.

#### Select and Place:

**Answer Area**

- FTP
- SMTP
- SNMP
- SSH
- TFTP
- VoIP

Connection Oriented

- 
- 
- 

Connectionless

- 
- 
- 

**Correct Answer:**

**Answer Area**

- FTP
- SMTP
- SNMP
- SSH
- TFTP
- VoIP

Connection Oriented

- FTP
- SMTP
- SSH

Connectionless

- SNMP
- TFTP
- VoIP

**Section: IP Services**  
**Explanation**

**Explanation/Reference:**

**QUESTION 72**

A network engineer must back up 20 network router configurations globally within a customer environment. Which protocol allows the engineer to perform this function using the Cisco IOS MIB?

- A. ARP
- B. SNMP
- C. SMTP
- D. CDP

**Correct Answer:** B  
**Section:** IP Services  
**Explanation**

**Explanation/Reference:**

#### QUESTION 73

Which command enables a router to become a DHCP client?

- A. `ip address dhcp`
- B. `ip dhcp client`
- C. `ip helper-address`
- D. `ip dhcp pool`

**Correct Answer:** B  
**Section:** IP Services  
**Explanation**

**Explanation/Reference:**

Reference: [https://www.cisco.com/c/en/us/td/docs/ios-xml/ios/ipaddr\\_dhcp/configuration/12-4/dhcp-12-4-book/config-dhcp-client.html](https://www.cisco.com/c/en/us/td/docs/ios-xml/ios/ipaddr_dhcp/configuration/12-4/dhcp-12-4-book/config-dhcp-client.html)

#### QUESTION 74

```
ip arp inspection vlan 5-10
interface fastethernet 0/1
  switchport mode access
  switchport access vlan 5
```

Refer to the exhibit. What is the effect of this configuration?

- A. The switch discards all ingress ARP traffic with invalid MAC-to-IP address bindings.
- B. All ARP packets are dropped by the switch.
- C. Egress traffic is passed only if the destination is a DHCP server.
- D. All ingress and egress traffic is dropped because the interface is untrusted.

**Correct Answer:** A  
**Section:** Security Fundamentals  
**Explanation**

**Explanation/Reference:**

#### QUESTION 75

When a site-to-site VPN is used, which protocol is responsible for the transport of user data?

- A. IPsec
- B. IKEv1
- C. MD5
- D. IKEv2

**Correct Answer:** A

**Section:** Security Fundamentals

**Explanation**

**Explanation/Reference:**

**QUESTION 76**

Which type of wireless encryption is used for WPA2 in preshared key mode?

- A. AES-128
- B. TKIP with RC4
- C. AES-256
- D. RC4

**Correct Answer:** C

**Section:** Security Fundamentals

**Explanation**

**Explanation/Reference:**

**QUESTION 77**

DRAG DROP

Drag and drop the threat-mitigation techniques from the left onto the types of threat or attack they mitigate on the right.

**Select and Place:**

**Answer Area**

Configure BPDU guard.	802.1q double tagging
Configure dynamic ARP inspection.	ARP spoofing
Configure root guard.	unwanted superior BPDUs
Configure VACL.	unwanted BPDUs on PortFast-enabled interfaces

**Correct Answer:**

## Answer Area

Configure BPDU guard.	Configure VACL.
Configure dynamic ARP inspection.	Configure dynamic ARP inspection.
Configure root guard.	Configure root guard.
Configure VACL.	Configure BPDU guard.

### Section: Security Fundamentals Explanation

Explanation/Reference:

#### QUESTION 78

Which command prevents passwords from being stored in the configuration as plain text on a router or switch?

- A. `enable secret`
- B. `enable password`
- C. `service password-encryption`
- D. `username cisco password encrypt`

Correct Answer: C

### Section: Security Fundamentals Explanation

Explanation/Reference:

#### QUESTION 79

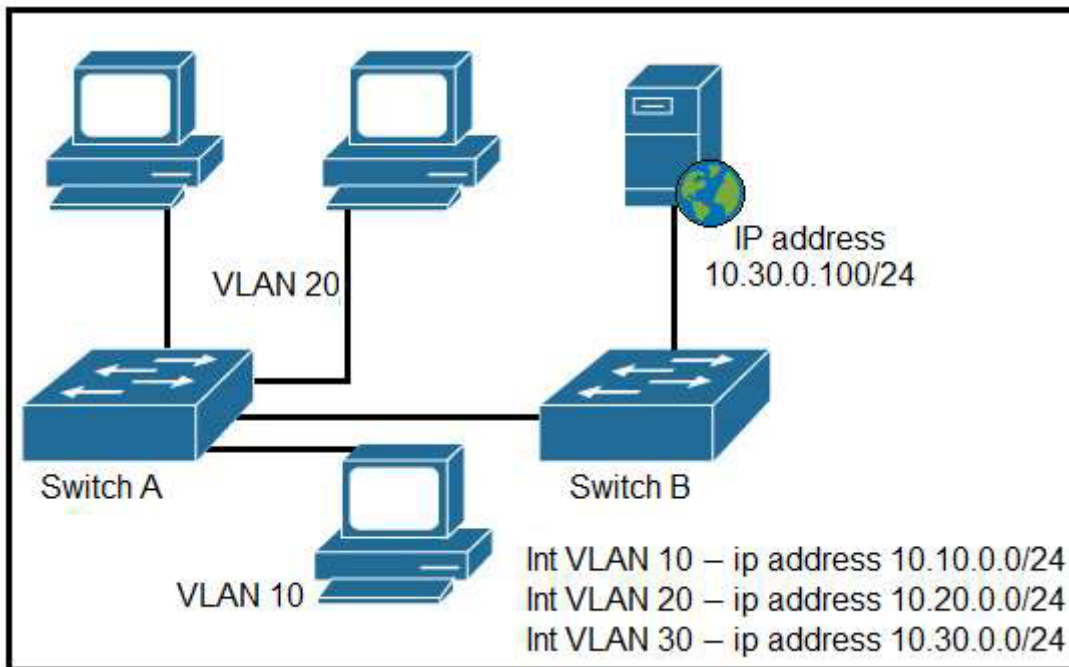

Refer to the exhibit. A network engineer must block access for all computers on VLAN 20 to the web server via HTTP. All other computer must be able to access the web server. Which configuration when applied to Switch A accomplishes the task?

- A. `config t`  
`ip access-list extended wwwblock`  
`permit ip any any`  
`deny tcp any host 10.30.0.100 eq 80`  
`int vlan 20`  
`ip access-group wwwblock in`
- B. `config t`  
`ip access-list extended wwwblock`  
`permit ip any any`  
`deny tcp any host 10.30.0.100 eq 80`  
`int vlan 30`  
`ip access-group wwwblock in`
- C. `config t`  
`ip access-list extended wwwblock`  
`deny tcp any host 10.30.0.100 eq 80`  
`int vlan 10`  
`ip access-group wwwblock in`
- D. `config t`  
`ip access-list extended wwwblock`  
`deny tcp any host 10.30.0.100 eq 80`  
`permit ip any any`  
`int vlan 20`  
`ip access-group wwwblock in`

**Correct Answer:** D  
**Section:** Security Fundamentals  
**Explanation**

**Explanation/Reference:**

**QUESTION 80**

```
ip arp inspection vlan 2
interface fastethernet 0/1
    switchport mode access
    switchport access vlan 2
```

Refer to the exhibit. What is the effect of this configuration?

- A. The switch port remains administratively down until the interface is connected to another switch.
- B. Dynamic ARP Inspection is disabled because the ARP ACL is missing.
- C. The switch port interface trust state becomes untrusted.
- D. The switch port remains down until it is configured to trust or untrust incoming packets.

**Correct Answer:** C  
**Section:** Security Fundamentals  
**Explanation**

**Explanation/Reference:**

**QUESTION 81**

What is the primary difference between AAA authentication and authorization?

- A. Authentication identifies and verifies a user who is attempting to access a system, and authorization controls that tasks the user can perform.
- B. Authentication controls the system processes a user can access, and authorization logs the activities the user initiates.
- C. Authentication verifies a username and password, and authorization handles the communication between the authentication agent and the user database.
- D. Authentication identifies a user who is attempting to access a system, and authorization validates the user's password.

**Correct Answer:** A  
**Section:** Security Fundamentals  
**Explanation**

**Explanation/Reference:**

**QUESTION 82**

When configuring a WLAN with WPA2 PSK in the Cisco Wireless LAN Controller GUI, which two formats are available to select? (Choose two.)

- A. decimal
- B. ASCII

- C. hexadecimal
- D. binary
- E. base64

**Correct Answer:** BC

**Section:** Security Fundamentals

**Explanation**

**Explanation/Reference:**

Reference: [https://www.cisco.com/c/en/us/td/docs/wireless/controller/7-4/configuration/guides/consolidated/b\\_cg74\\_CONSOLIDATED/b\\_cg74\\_CONSOLIDATED\\_chapter\\_01010001.html](https://www.cisco.com/c/en/us/td/docs/wireless/controller/7-4/configuration/guides/consolidated/b_cg74_CONSOLIDATED/b_cg74_CONSOLIDATED_chapter_01010001.html)

**QUESTION 83**

DRAG DROP

Drag and drop AAA functions from the left onto the correct AAA services on the right.

**Select and Place:**

**Answer Area**

controls the actions that a user can perform	Authentication <input type="text"/> <input type="text"/>
provides analytical information for the network administrator	
records user activities	Authorization <input type="text"/> <input type="text"/>
restricts the services that are available to a user	
verifies the password associated with a user	Accounting <input type="text"/> <input type="text"/>
identifies the user	

**Correct Answer:**

## Answer Area

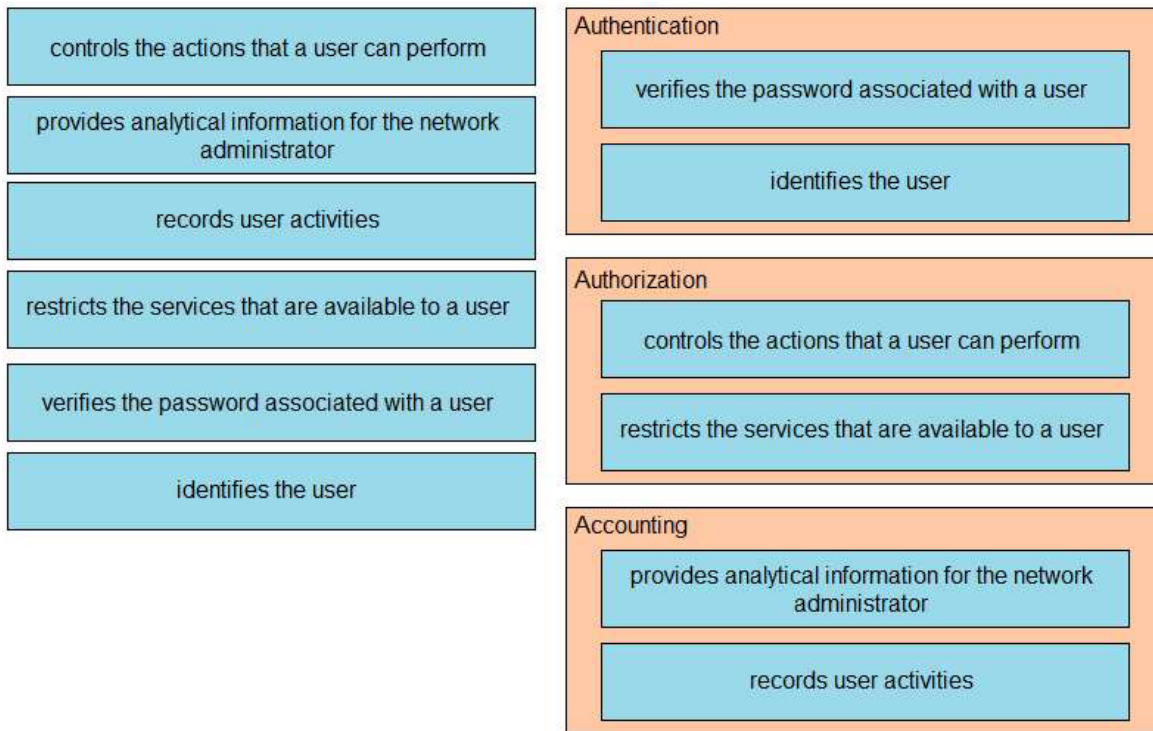

### Section: Security Fundamentals

#### Explanation

#### Explanation/Reference:

#### QUESTION 84

An engineer is asked to protect unused ports that are configured in the default VLAN on a switch. Which two steps will fulfill the request? (Choose two.)

- A. Configure the ports as trunk ports.
- B. Enable the Cisco Discovery Protocol.
- C. Configure the port type as access and place in VLAN 99.
- D. Administratively shut down the ports.
- E. Configure the ports in an EtherChannel.

**Correct Answer:** CD

### Section: Security Fundamentals

#### Explanation

#### Explanation/Reference:

#### QUESTION 85

An email user has been lured into clicking a link in an email sent by their company's security organization. The webpage that opens reports that it was safe, but the link could have contained malicious code.

Which type of security program is in place?

- A. user awareness
- B. brute force attack
- C. physical access control
- D. social engineering attack

**Correct Answer:** A

**Section:** Security Fundamentals

**Explanation**

**Explanation/Reference:**

**QUESTION 86**

DRAG DROP

Drag and drop the Cisco Wireless LAN Controller security settings from the left onto the correct security mechanism categories on the right.

**Select and Place:**

**Answer Area**

web policy
Passthrough
WPA+WPA2
802.1X

Layer 2 Security Mechanisms
Layer 3 Security Mechanisms (for WLAN)

**Correct Answer:**

## Answer Area

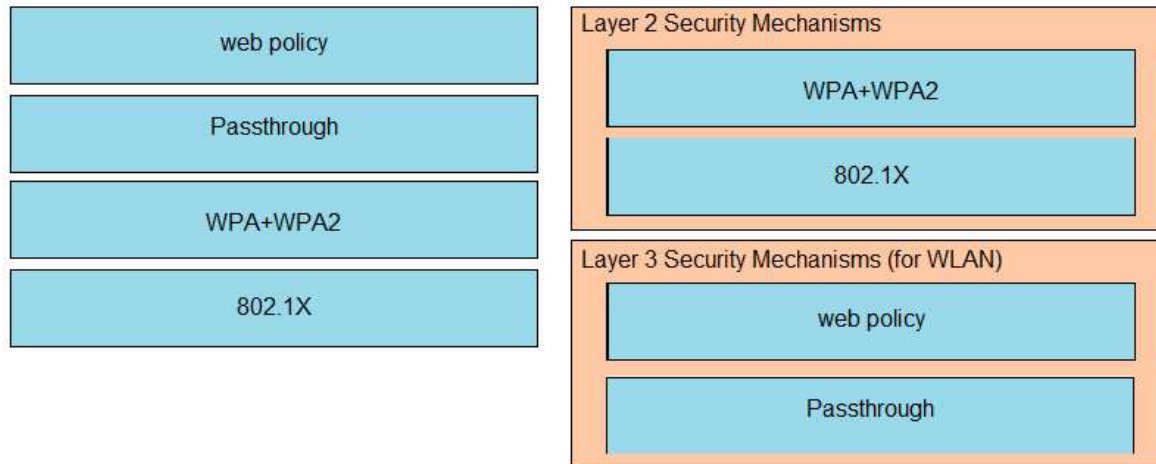

### Section: Security Fundamentals

#### Explanation

#### Explanation/Reference:

#### QUESTION 87

Which feature on the Cisco Wireless LAN Controller when enabled restricts management access from specific networks?

- A. TACACS
- B. CPU ACL
- C. Flex ACL
- D. RADIUS

**Correct Answer: B**

### Section: Security Fundamentals

#### Explanation

#### Explanation/Reference:

Reference: <https://www.cisco.com/c/en/us/support/docs/wireless-mobility/wlan-security/71978-acl-wlc.html>

#### QUESTION 88

Which set of actions satisfy the requirement for multifactor authentication?

- A. The user enters a user name and password, and then re-enters the credentials on a second screen.
- B. The user swipes a key fob, then clicks through an email link.
- C. The users enters a user name and password, and then clicks a notification in an authentication app on a mobile device.
- D. The user enters a PIN into an RSA token, and then enters the displayed RSA key on a login screen.

**Correct Answer: C**

### Section: Security Fundamentals

#### Explanation

#### Explanation/Reference:

### QUESTION 89

Which configuration is needed to generate an RSA key for SSH on a router?

- A. Configure VTY access.
- B. Configure the version of SSH.
- C. Assign a DNS domain name.
- D. Create a user with a password.

**Correct Answer: C**

**Section: Security Fundamentals**

**Explanation**

**Explanation/Reference:**

### QUESTION 90

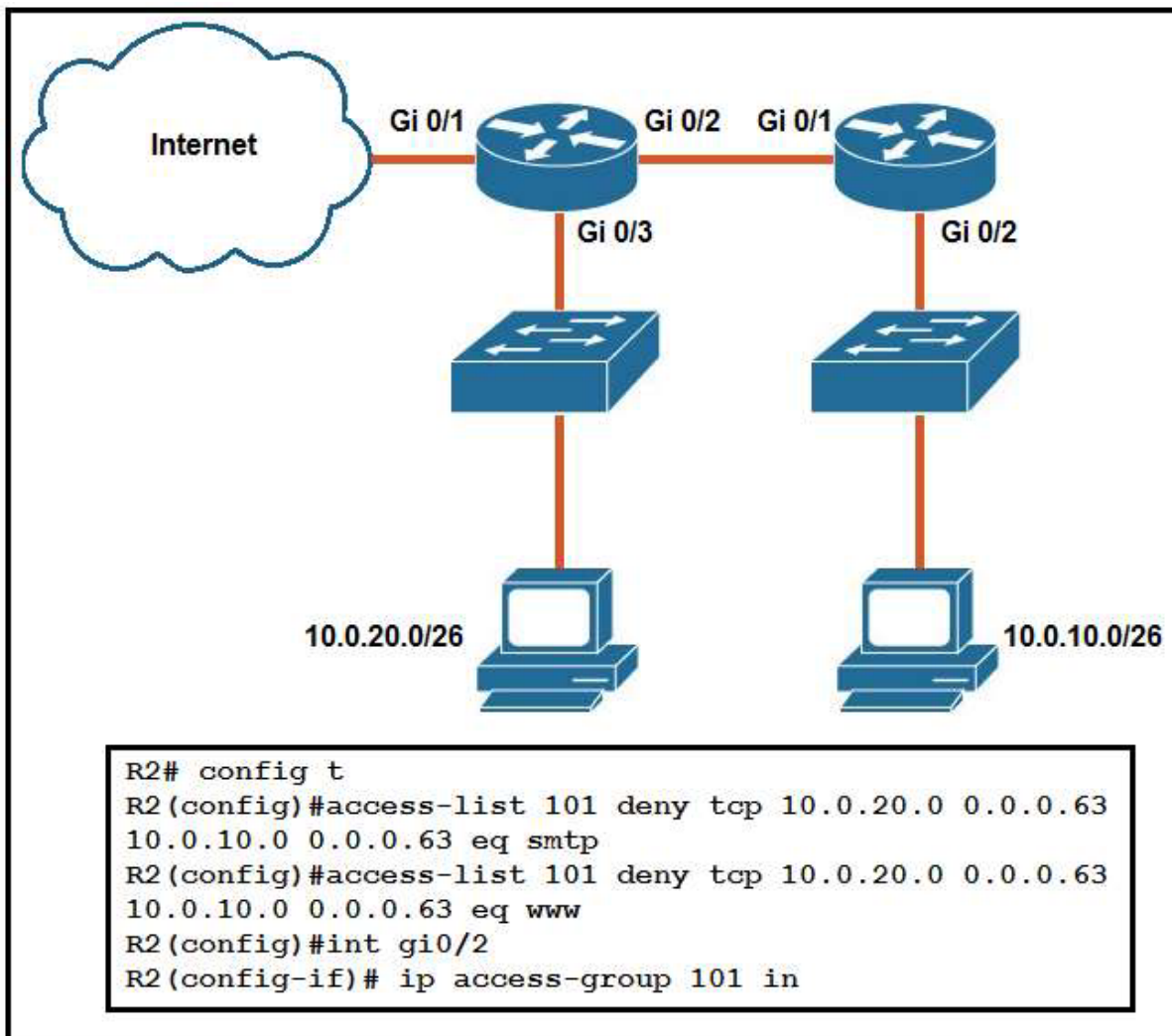

Refer to the exhibit. An extended ACL has been configured and applied to router R2. The configuration failed to work as intended.

Which two changes stop outbound traffic on TCP ports 25 and 80 to 10.0.20.0/26 from the 10.0.10.0/26 subnet while still allowing all other traffic? (Choose two.)

- A. Add a "permit ip any any" statement at the end of ACL 101 for allowed traffic.
- B. Add a "permit ip any any" statement to the beginning of ACL 101 for allowed traffic.
- C. The ACL must be moved to the Gi0/1 interface outbound on R2.
- D. The source and destination IPs must be swapped in ACL 101.
- E. The ACL must be configured the Gi0/2 interface inbound on R1.

**Correct Answer:** AD

**Section:** Security Fundamentals

**Explanation**

**Explanation/Reference:**

#### **QUESTION 91**

An engineer must configure a WLAN using the strongest encryption type for WPA2-PSK. Which cipher fulfills the configuration requirement?

- A. WEP
- B. AES
- C. RC4
- D. TKIP

**Correct Answer:** B

**Section:** Security Fundamentals

**Explanation**

**Explanation/Reference:**

#### **QUESTION 92**

Which statement correctly compares traditional networks and controller-based networks?

- A. Only controller-based networks decouple the control plane and the data plane.
- B. Traditional and controller-based networks abstract policies from device configurations.
- C. Only traditional networks natively support centralized management.
- D. Only traditional networks offer a centralized control plane.

**Correct Answer:** A

**Section:** Automation and Programmability

**Explanation**

**Explanation/Reference:**

#### **QUESTION 93**

What are two benefits of network automation? (Choose two.)

- A. reduced hardware footprint
- B. reduced operational costs
- C. faster changes with more reliable results
- D. fewer network failures

E. increased network security

**Correct Answer:** BC

**Section:** Automation and Programmability

**Explanation**

**Explanation/Reference:**

**QUESTION 94**

Which two encoding methods are supported by REST APIs? (Choose two.)

- A. SGML
- B. YAML
- C. XML
- D. JSON
- E. EBCDIC

**Correct Answer:** CD

**Section:** Automation and Programmability

**Explanation**

**Explanation/Reference:**

Reference: [https://www.cisco.com/c/en/us/td/docs/switches/datacenter/nexus1000/sw/5\\_x/rest\\_api\\_config/b\\_Cisco\\_N1KV\\_VMware\\_REST\\_API\\_Config\\_5x/b\\_Cisco\\_N1KV\\_VMware\\_REST\\_API\\_Config\\_5x\\_chapter\\_010.pdf](https://www.cisco.com/c/en/us/td/docs/switches/datacenter/nexus1000/sw/5_x/rest_api_config/b_Cisco_N1KV_VMware_REST_API_Config_5x/b_Cisco_N1KV_VMware_REST_API_Config_5x_chapter_010.pdf)

**QUESTION 95**

What are two characteristics of a controller-based network? (Choose two.)

- A. It uses Telnet to report system issues.
- B. The administrator can make configuration updates from the CLI.
- C. It uses northbound and southbound APIs to communicate between architectural layers.
- D. It decentralizes the control plane, which allows each device to make its own forwarding decisions.
- E. It moves the control plane to a central point.

**Correct Answer:** CE

**Section:** Automation and Programmability

**Explanation**

**Explanation/Reference:**

**QUESTION 96**

Which output displays a JSON data representation?

- A. 

```
{
  "response": {
    "taskId": {},
    "url": "string"
  },
  "version": "string"
}
```

B. {  
 "response"- {  
 "taskld"- {},  
 "url"- "string"  
 },  
 "version"- "string"  
}

C. {  
 "response": {  
 "taskld": {},  
 "url": "string"  
 },  
 "version": "string"  
}

D. {  
 "response". {  
 "taskld". {};  
 "url". "string"  
 };  
 "version". "string"  
}

**Correct Answer:** C

**Section:** Automation and Programmability

**Explanation**

**Explanation/Reference:**

#### QUESTION 97

DRAG DROP

Drag and drop the descriptions from the left onto the correct configuration-management technologies on the right.

**Select and Place:**

### Answer Area

- fundamental configuration elements are stored in a manifest
- uses TCP port 10002 for configuration push jobs
- uses Ruby for fundamental configuration elements
- uses SSH for remote device communication
- uses TCP 8140 for communication
- uses YAML for fundamental configuration elements

Ansible

Chef

Puppet

### Correct Answer:

### Answer Area

- fundamental configuration elements are stored in a manifest
- uses TCP port 10002 for configuration push jobs
- uses Ruby for fundamental configuration elements
- uses SSH for remote device communication
- uses TCP 8140 for communication
- uses YAML for fundamental configuration elements

Ansible

- uses SSH for remote device communication
- uses YAML for fundamental configuration elements

Chef

- uses TCP port 10002 for configuration push jobs
- uses Ruby for fundamental configuration elements

Puppet

- fundamental configuration elements are stored in a manifest
- uses TCP 8140 for communication

**Section: Automation and Programmability**

**Explanation**

**Explanation/Reference:**

**QUESTION 98**

Which two capabilities of Cisco DNA Center make it more extensible? (Choose two.)

- A. REST APIs that allow for external applications to interact natively with Cisco DNA Center
- B. adapters that support all families of Cisco IOS Software
- C. SDKs that support interaction with third-party network equipment
- D. modular design that is upgradable as needed
- E. customized versions for small, medium, and large enterprises

**Correct Answer: AC**

**Section: Automation and Programmability**

**Explanation**

**Explanation/Reference:**

**QUESTION 99**

What are two southbound APIs? (Choose two.)

- A. Thrift
- B. DSC
- C. CORBA
- D. NETCONF
- E. OpenFlow

**Correct Answer: DE**

**Section: Automation and Programmability**

**Explanation**

**Explanation/Reference:**

**QUESTION 100**

What makes Cisco DNA Center different from traditional network management applications and their management of networks?

- A. Its modular design allows someone to implement different versions to meet the specific needs of an organization.
- B. It only supports auto-discovery of network elements in a greenfield deployment.
- C. It does not support high availability of management functions when operating in cluster mode.
- D. It abstracts policy from the actual device configuration.

**Correct Answer: D**

**Section: Automation and Programmability**

**Explanation**

**Explanation/Reference:**

**QUESTION 101**

Which API is used in controller-based architectures to interact with edge devices?

- A. southbound
- B. overlay
- C. northbound
- D. underlay

**Correct Answer:** A

**Section:** Automation and Programmability

**Explanation**

**Explanation/Reference:**

**QUESTION 102**

An organization has decided to start using cloud-provided services. Which cloud service allows the organization to install its own operating system on a virtual machine?

- A. platform-as-a-service
- B. network-as-a-service
- C. software-as-a-service
- D. infrastructure-as-a-service

**Correct Answer:** D

**Section:** Automation and Programmability

**Explanation**

**Explanation/Reference:**